



# PETERSON

VEHICLE SAFETY LIGHTING



1945 - 2020





75 YEARS OF LIGHTS

...AND HIGHLIGHTS.

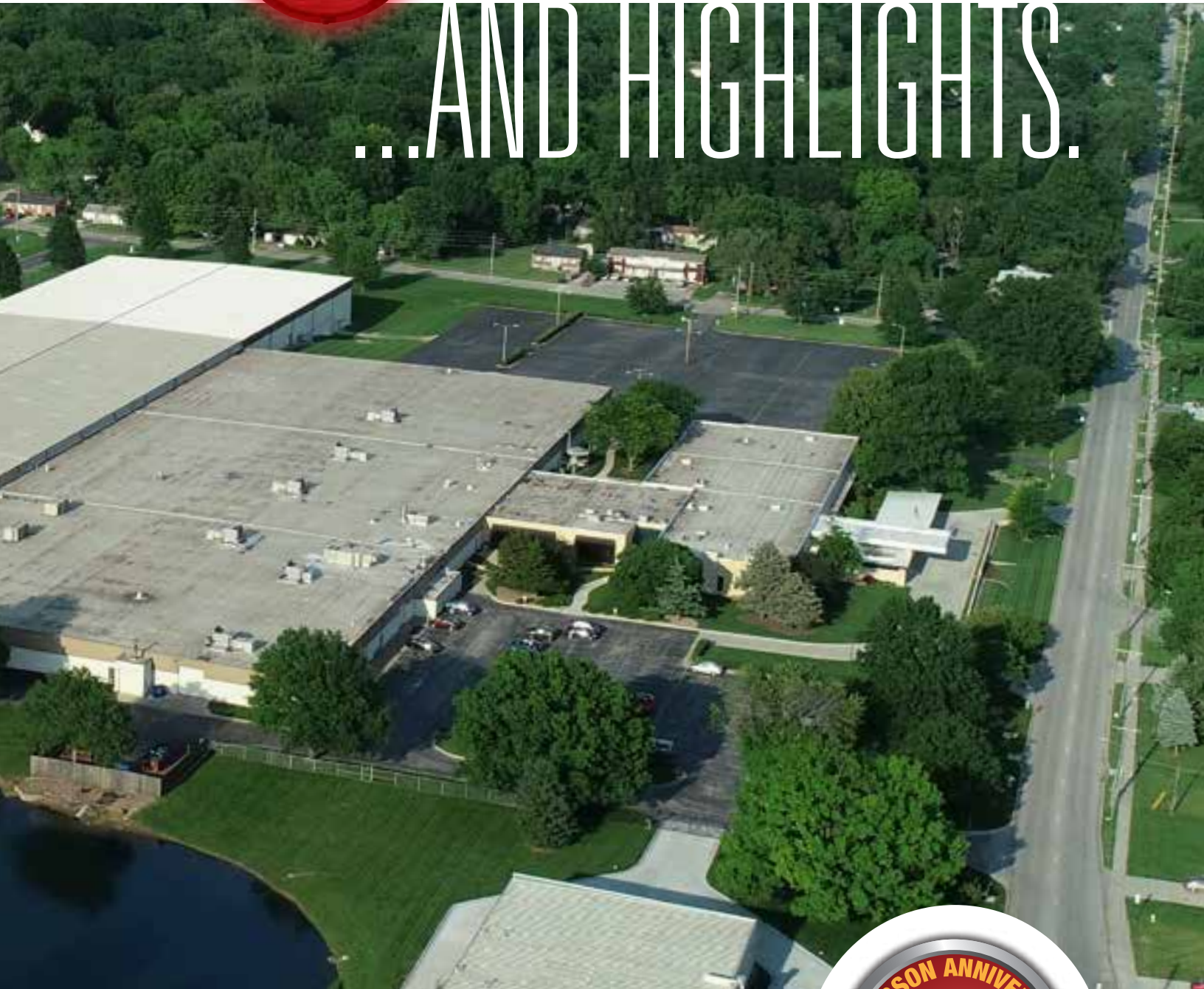

*Our goal is not to be the biggest.  
Just the best.*



## How To Use The Quick-Reference Icons In This Catalog

A series of handy, quick-reference icons runs down the center of nearly every product page in this catalog. These icons allow you to determine the major features of a particular Peterson product at a glance and compare similar products to determine which one is right for you.

Below is a complete index of all the icons, along with a description of what each one means to you.

### APPLICABLE TO ALL PRODUCTS



Item appears in the Peterson Master Catalog for the first time.



Item is available in our retail-friendly visual packaging.



Product is manufactured in the United States of America.



Item is submersible and especially suitable for use on boat trailers and other vehicles used around water.



One or more versions of this product are designed for use with 24-volt systems.



Denotes clearance/marker lights that are PC rated. For additional information on the PC rating, see page 268.



Indicates that a light has integrated retro-reflector functionality that meets applicable legal requirements.



One or more versions of this product are available with a quick-mount magnetic base.



Indicates that a product either meets ECE lighting requirements only, or meets both ECE and U.S. DOT requirements. See page 158.



Non-Peterson trade names appearing in this catalog are used for descriptive purposes only. Peterson acknowledges that these trademarks remain the property of their respective owners.

### FOR INCANDESCENT PRODUCTS



Indicates the number of bulbs in each incandescent light equipped with multiple bulbs.



Item is equipped with our long life VIBAR or VIBAR II shock-absorbing incandescent socket.



Indicates that Peterson offers an LED light of similar form and function.



Indicates that an incandescent bulb is equipped with a premium bulb with a life rating of up to 15,000 hours.

### FOR LED PRODUCTS



Indicates the number of light emitting diodes in each of our LED lights. In some cases, related versions may have different diode counts.



Approved for Maxi-Seal® Defender® harness system's Lifetime Limited Corrosion Warranty. (Ask for details.)



Product is part of our new LumenX® line of premium LED lights.



An LED product equipped with integrated hardwired leads, eliminating corrosion-prone connection at light housing.



LED warning light with high-intensity strobing diodes.



LED product is multi-volt compatible for use with both 12V and 24V systems.



Indicates a premium LED product with integrated voltage regulation circuitry for consistent output and long life.



One or more versions of this LED light feature a clear lens with diodes that light up in the appropriate color.



# TABLE OF CONTENTS

## STOP, TURN & TAIL 4–33

LED Stop, Turn & Tail Lights.....	4–17
LED Combination Rear Lights.....	18–19
LED Trailer Light Kits.....	20
Incandescent Stop, Turn & Tail Lights.....	21–26
Incandescent Combination Rear Lights.....	26–31
Incandescent Trailer Light Kits.....	32–33

## TURN SIGNALS 34–53

LED Turn Signals.....	34–44
LED Auxiliary Turn Signals.....	44–45
LED Mid-Turn Lights.....	46–47
Incandescent Turn Signals.....	48–53

## CLEARANCE, MARKER & ID 54–93

LED Clearance & Side Marker Lights.....	54–73
LED Clearance & Side Marker Lights with Aux.....	74–75
LED Auxiliary Marker & Accessory Lights.....	76
Incandescent Clearance, Side Marker & Cab Lights.....	77–91
LED Identification Bar Lights.....	92
Incandescent Identification Bar Lights.....	93

## BACK-UP, LICENSE, UTILITY & DOME 94–121

LED Back-Up Lights.....	94–99
Incandescent Back-Up Lights.....	100–101
LED System Monitoring Lights.....	102
LED License & Utility Lights.....	103–107
Incandescent License & Utility Lights.....	108–112
LED Dome & Interior Lights.....	113–119
Incandescent Dome & Interior Lights.....	120–121

## SPECIALTY LIGHTING 122–139

LED Headlights.....	122–123
LED Work Lights.....	123–131
LED Light Bars.....	132–133
Incandescent Work Lights & Snow Plow Lights.....	134–136
Halogen Fog, Driving & Off-Road Lights.....	137–138
LED & Incandescent Tow Light Kits.....	139

## WARNING & EMERGENCY 140–157

LED Auxiliary Strobes.....	140–143
Multi-Function Lights & Strobes.....	144–145
LED Flashing Warning Lights & Beacons.....	146
Incandescent Flashing & Revolving Beacons.....	147–148
LED Strobming Beacons.....	149–152
Xenon Strobming Beacons.....	153–155
Halogen, Xenon & LED Light Bars.....	156–157
LED Directional Warning Arrows.....	157

## EUROPEAN (ECE) LIGHTING 158–170

LED Headlights.....	158
LED Combination Lights.....	159–160
LED Round Lights.....	161–164
LED Oval Lights.....	165–166
LED Rectangular Lights.....	167–168
LED Outline & Marker Lights.....	169–170
LED Number Plate Lights.....	103
ECE Reflectors.....	238

## MOUNTING ACCESSORIES 171–194

Grommets, Brackets & Bezels.....	171–192
License Plate Brackets.....	191
Theft-Deterrent Rings.....	193
Certificate Holders.....	194
ABS Label.....	194

## ELECTRICAL ACCESSORIES 195–227

Flashers.....	195–196
Back-Up Alarms.....	197–198
Plugs, Pigtails & Lead Wires.....	199–209
Trailer Nose Box.....	210
Connectors & Adapters.....	211–213
Trailer Wiring & Harnesses.....	214
Switches & Indicator Lights.....	215–220
Wiring & Terminals.....	221–226
Electrical Tools.....	227

## CONSPICUITY & REFLECTORS 228–239

Reflective Tape.....	228–231
Spitfire® Reflectors.....	232–233
Driveway Markers.....	234
Reflectors.....	234–238
Warning Triangles.....	239
SMV Emblems.....	239

## RELATED ACCESSORIES 240–255

Convex Mirrors.....	240–241
Universal Mirrors.....	242–243
Replacement Mirror Heads.....	244–245
Antennas.....	246–247
Bearing Protectors.....	248
Replacement Bulbs.....	248–250
Replacement Lenses.....	251–255

## MERCHANDISING 256–259

Plan-A-Gram Summary.....	256
Lighted Wall Displays.....	257
Header/Fixture Signs.....	258
Counter Displays & Point-of-Purchase Support.....	259

## TECHNICAL & REFERENCE 260–286

Federal Lighting Requirements.....	260–265
Glossary.....	266–267
Rating, Codes, & Standards.....	268–270
Measurement Conversion.....	270
Beam Pattern Definitions.....	271
LED Amp Draw Specifications.....	272–273
Grommet & Flange Mounting Dimensions.....	274
Installation Instructions.....	274
Obsolete Part Numbers.....	275
Competitive Interchanges.....	276–279
Warranty Terms.....	280
Part Number Index.....	281–286

*Dimensional illustrations and schematics shown in this catalog are intended to provide general marketing information only. Details and measurements may be approximate, and should not be relied on for engineering purposes.*

# STOP TURN & TAIL LIGHTS



## 817-7/818-7 LumenX® LED 4" Round Stop, Turn & Tail Light



- White diodes behind red lens.
- Advanced optics fully illuminate lens.
- AMP-compatible connector integrated into housing.
- 818-7 has flange integrated into the housing.
- 817-7 has skirted weld joint for added protection against moisture.
- 9–16 volt operating range.
- Regulated design provides voltage protection and consistent light output over a wide voltage range.
- Does not require “Top” positioning to meet FMVSS 108 standard.
- 817 kit includes light, grommet and 817-49 plug.
- 818 kit includes light and 817-49 plug.

Order No.	Description	Pack	Std Carton
V818R-7	flange mount	Viz Pack	6
817R-7	grommet mount	poly pack	6
818R-7	flange mount	poly pack	6
817KR-7	<b>KIT</b> grommet mount kit	poly pack	6
818KR-7	<b>KIT</b> flange mount kit	poly pack	6
M817R-7	grommet mount	mfg. pack	50
M818R-7	flange mount	mfg. pack	50
426-18	grommet	poly pack	12
B426-18	grommet	mfg. pack	100
417-49	hardshell plug	poly pack	6
B417-49	hardshell plug	mfg. pack	100
817-49	molded plug	poly pack	12
B817-49	molded plug	mfg. pack	100

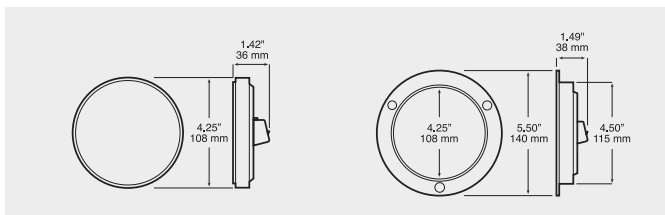

# LED STOP TURN & TAIL



## 824-7/826-7 LumenX® LED 4" Round Stop, Turn & Tail Light



- White diodes behind red lens.
- Advanced optics fully illuminate lens.
- Industry-standard PL3 socket integrated into housing.
- 824-7 has flange integrated into the housing.
- 826-7 has skirted weld joint for added protection against moisture.
- 9–16 volt operating range.
- Regulated design provides voltage protection and consistent light output over a wide voltage range.
- Does not require “Top” positioning to meet FMVSS 108 standard.
- 826 kit includes light, grommet and 431-491 plug.
- 824 kit includes light and 431-491 plug.

Order No.	Description	Pack	Std Carton
V826KR-7	<b>KIT</b> grommet mount kit	Viz Pack	6
V824KR-7	<b>KIT</b> flange mount kit	Viz Pack	6
826R-7	grommet mount	poly pack	6
824R-7	flange mount	poly pack	6
826KR-7	<b>KIT</b> grommet mount kit	poly pack	6
824KR-7	<b>KIT</b> flange mount kit	poly pack	6
M826R-7	grommet mount	mfg. pack	50
M824R-7	flange mount	mfg. pack	50
426-18	grommet	poly pack	12
B426-18	grommet	mfg. pack	100
431-491	plug	poly pack	12
B431-491	plug	mfg. pack	100

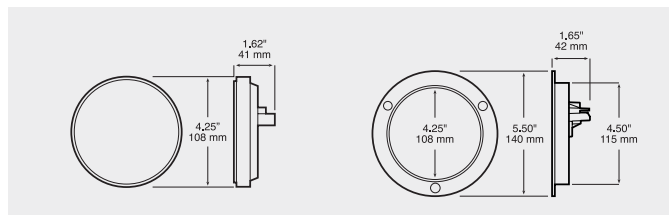

# LED STOP TURN & TAIL



## 817-9/818-9 LumenX® LED 4" Round Stop, Turn & Tail Light



- White diodes behind red lens.
- Advanced optics fully illuminate lens.
- AMP-compatible connector integrated into housing.
- Regulated design provides voltage protection and consistent light output over a wide voltage range.
- 818-9 has flange integrated into the housing.
- 817-9 has skirted weld joint for added protection against moisture.
- 9-32 volt operating range is compatible with 12V and 24V vehicles.
- Does not require "Top" positioning to meet FMVSS 108 standard.
- 817 kit includes light, grommet and 817-49 plug.
- 818 kit includes light and 817-49 plug.

Order No.	Description	Pack	Std Carton
817R-9	grommet mount	poly pack	6
818R-9	flange mount	poly pack	6
817KR-9	<b>KIT</b> grommet mount kit	poly pack	6
818KR-9	<b>KIT</b> flange mount kit	poly pack	6
M817R-9	grommet mount	mfg. pack	50
M818R-9	flange mount	mfg. pack	50
426-18	grommet	poly pack	12
B426-18	grommet	mfg. pack	100
417-49	hardshell plug	poly pack	6
B417-49	hardshell plug	mfg. pack	100
817-49	molded plug	poly pack	12
B817-49	molded plug	mfg. pack	100

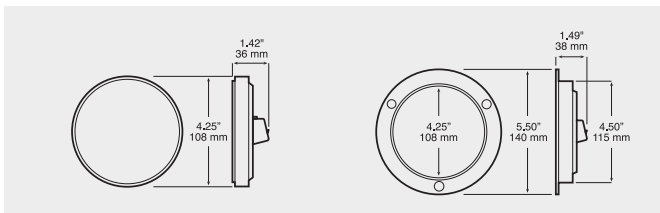

# STOP TURN & TAIL LIGHTS



## 824-9/826-9 LumenX® LED 4" Round Stop, Turn & Tail Light



- White diodes behind red lens.
- Advanced optics fully illuminate lens.
- Industry-standard PL3 socket integrated into housing.
- Regulated design provides voltage protection and consistent light output over a wide voltage range.
- 824-9 has flange integrated into the housing.
- 826-9 has skirted weld joint for added protection against moisture.
- 9-32 volt operating range is compatible with 12V and 24V vehicles.
- Does not require "Top" positioning to meet FMVSS 108 standard.
- 826 kit includes light, grommet and 431-491 plug.
- 824 kit includes light and 431-491 plug.

Order No.	Description	Pack	Std Carton
826R-9	grommet mount	poly pack	6
824R-9	flange mount	poly pack	6
826KR-9	<b>KIT</b> grommet mount kit	poly pack	6
824KR-9	<b>KIT</b> flange mount kit	poly pack	6
M826R-9	grommet mount	mfg. pack	50
M824R-9	flange mount	mfg. pack	50
426-18	grommet	poly pack	12
B426-18	grommet	mfg. pack	100
431-491	plug	poly pack	12
B431-491	plug	mfg. pack	100

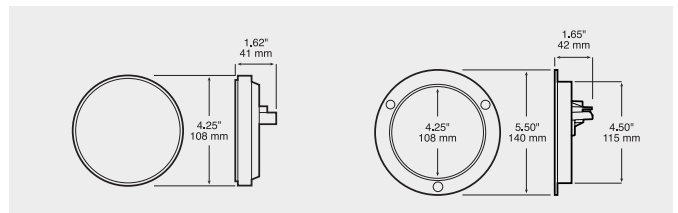

ST

TURN

MARKER

B-U/UTIL

SPEC

EMERG

ECE

MOUNT

ELECT

REFLECT

ACCY

MERCH

TECH

# STOP TURN & TAIL LIGHTS



## 820-7/823-7 LumenX® LED Oval Stop/Turn/Tail Light



- White diodes behind red lens.
- Advanced optics fully illuminate lens.
- AMP-compatible connector integrated into housing.
- 823-7 has flange welded to light, forming a single unit.
- 820 kit includes light, grommet and 817-49 plug.
- 823 kit includes light and 817-49 plug.
- 823RTL-7 version has integral narrower flange with recessed lens and two mounting holes positioned at ends for narrower rail applications.
- 9–16 volt operating range.
- Regulated design provides voltage protection and consistent light output over a wide voltage range.
- Meets FMVSS 108 req. in horizontal, vertical or any 360° position.

Order No.	Description	Pack	Std Carton
820R-7	grommet mount	poly pack	6
823R-7	flange mount	poly pack	6
823RTL-7	narrow, 2-screw flange	poly pack	6
820KR-7	<b>KIT</b> grommet mount kit	poly pack	6
823KR-7	<b>KIT</b> flange mount kit	poly pack	6
M820R-7	grommet mount	mfg. pack	50
M823R-7	flange mount	mfg. pack	50
M823RTL-7	narrow, 2-screw flange	mfg. pack	50
421-18	grommet	poly pack	12
B421-18	grommet	mfg. pack	100
417-49	hardshell plug	poly pack	6
B417-49	hardshell plug	mfg. pack	100
817-49	molded plug	poly pack	12
B817-49	molded plug	mfg. pack	100

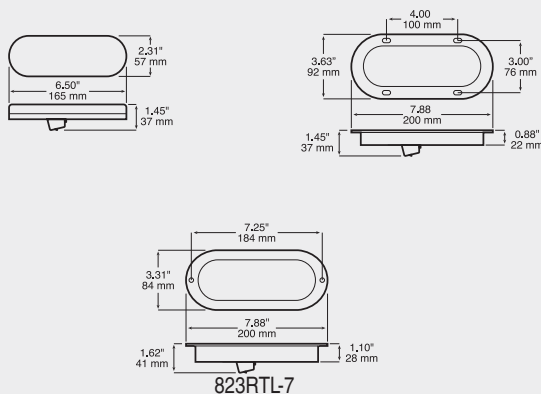

# LED STOP TURN & TAIL



## 821-7/822-7 LumenX® LED Oval Stop/Turn/Tail Light



- White diodes behind red lens.
- Advanced optics fully illuminate lens.
- Industry-standard PL3 socket integrated into housing.
- 822-7 has flange welded to light, forming a single unit.
- 9–16 volt operating range.
- Regulated design provides voltage protection and consistent light output over a wide voltage range.
- Meets FMVSS 108 requirements in horizontal, vertical or any 360° position.
- 821 kit includes light, grommet and 421-491 plug.
- 822 kit includes light and 421-491 plug.

Order No.	Description	Pack	Std Carton
V821KR-7	<b>KIT</b> grommet mount kit	Viz Pack	6
V822KR-7	<b>KIT</b> flange mount kit	Viz Pack	6
821R-7	grommet mount	poly pack	6
822R-7	flange mount	poly pack	6
821KR-7	<b>KIT</b> grommet mount kit	poly pack	6
822KR-7	<b>KIT</b> flange mount kit	poly pack	6
M821R-7	grommet mount	mfg. pack	50
M822R-7	flange mount	mfg. pack	50
421-18	grommet	poly pack	12
B421-18	grommet	mfg. pack	100
421-491	plug	poly pack	12
B421-491	plug	mfg. pack	100

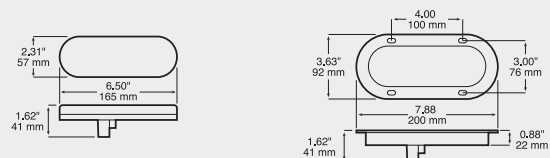



# LED STOP TURN & TAIL



## 820-10/823-10 LumenX® LED Oval Stop/Turn/Tail Light



- White diodes behind red lens.
- Advanced optics fully illuminate lens.
- AMP-compatible connector integrated into housing.
- Regulated design provides voltage protection and consistent light output over a wide voltage range.
- 823-10 has flange welded to light, forming a single unit.
- 9-32 volt operating range is compatible with 12V and 24V vehicles.
- Meets FMVSS 108 requirements in horizontal, vertical or any 360° position.
- 820 kit includes light, grommet and 817-49 plug.
- 823 kit includes light and 817-49 plug.

Order No.	Description	Pack	Std Carton
820R-10	grommet mount	poly pack	6
823R-10	flange mount	poly pack	6
820KR-10	<b>KIT</b> grommet mount kit	poly pack	6
823KR-10	<b>KIT</b> flange mount kit	poly pack	6
M820R-10	grommet mount	mfg. pack	50
M823R-10	flange mount	mfg. pack	50
M823RTL-10	narrow, 2-screw flange	mfg. pack	50
421-18	grommet	poly pack	12
B421-18	grommet	mfg. pack	100
417-49	hardshell plug	poly pack	6
B417-49	hardshell plug	mfg. pack	100
817-49	molded plug	poly pack	12
B817-49	molded plug	mfg. pack	100

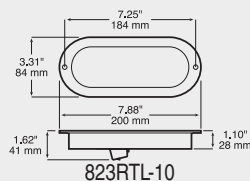
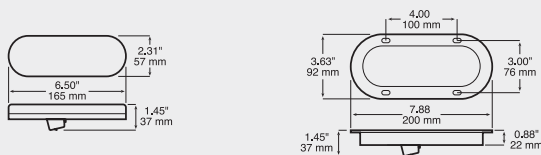

# STOP TURN & TAIL LIGHTS



## 821-10/822-10 LumenX® LED Oval Stop/Turn/Tail Light



- White diodes behind red lens.
- Advanced optics fully illuminate lens.
- Industry-standard PL3 socket integrated into housing.
- Regulated design provides voltage protection and consistent light output over a wide voltage range.
- 822-10 has flange welded to light, forming a single unit.
- 9-32 volt operating range is compatible with 12V and 24V vehicles.
- Meets FMVSS 108 requirements in horizontal, vertical or any 360° position.
- 821 kit includes light, grommet and 421-491 plug.
- 822 kit includes light and 421-491 plug.

Order No.	Description	Pack	Std Carton
821R-10	grommet mount	poly pack	6
822R-10	flange mount	poly pack	6
821KR-10	<b>KIT</b> grommet mount kit	poly pack	6
822KR-10	<b>KIT</b> flange mount kit	poly pack	6
M821R-10	grommet mount	mfg. pack	50
M822R-10	flange mount	mfg. pack	50
421-18	grommet	poly pack	12
B421-18	grommet	mfg. pack	100
421-491	plug	poly pack	12
B421-491	plug	mfg. pack	100

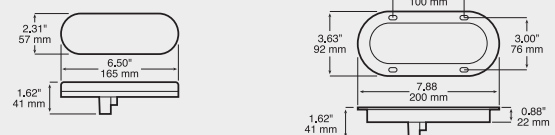

ST  
TURN  
MARKER  
B-U/UTIL  
SPEC  
EMERG  
ECE  
MOUNT  
ELECT  
REFLECT  
ACCY  
MERCH  
TECH

# STOP TURN & TAIL LIGHTS



**TRADITIONAL 36 DIODE  
PIRANHA®**



## 417/418 Piranha® LED 4" Round Stop/Turn/Tail Light



- Original 36-diode Piranha multi-diode lens look.
- 418 has flange welded to light, forming a single unit.
- 417 has skirted weld joint for added protection against moisture.
- 9-16 volt operating range.
- Reverse voltage protection prevents damage if mis-installed.
- Does not require "Top" positioning to meet FMVSS 108 standards.
- Lights have hardwired leads with a built-in PL3 3-wire adapter plug, except for M417R and M418R, which have stripped leads.
- Viz Packs include LED light with built-in adapter plug.
- V417KR kit includes 417R-P light and 426-18 mounting grommet.
- See page 38 for matching amber turn signal.

Order No.	Description	Pack	Std Carton
V417KR	<b>KIT</b> red kit w/ adapter plug	Viz Pack	6
V418KR	<b>KIT</b> red w/ flange & adapter plug	Viz Pack	6
M417R	red w/ stripped leads	mfg. pack	50
M418R	red w/ flange & stripped leads	mfg. pack	50
M417R-P	red w/ adapter plug	mfg. pack	50
M418R-P	red w/ flange & adapter plug	mfg. pack	50
426-18	grommet	poly pack	12
B426-18	grommet	mfg. pack	100

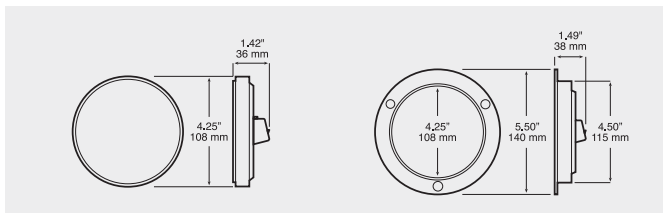

# LED STOP TURN & TAIL



**TRADITIONAL 36 DIODE  
PIRANHA®**



## 817-36/818-36 Piranha® LED 4" Round Stop/Turn/Tail Light



- Original 36-diode Piranha multi-diode lens look.
- AMP-compatible connector integrated into housing.
- Advanced white diodes behind red lens.
- 818-36 has flange welded to light, forming a single unit.
- 817-36 has skirted weld joint for added protection against moisture.
- 9-16 volt operating range.
- Regulated design provides voltage protection and consistent light output over a wide voltage range.
- Does not require "Top" positioning to meet FMVSS 108 standard.
- V817KR-36 Viz-Pack kit includes light, grommet and 417-49 plug.
- See page 14 for clear lens version.
- See page 38 for matching amber turn signal.

Order No.	Description	Pack	Std Carton
V817KR-36	<b>KIT</b> red, grommet mount	Viz Pack	6
817R-36	red, grommet mount	poly pack	6
818R-36	red, flange mount	poly pack	6
M817R-36	red, grommet mount	mfg. pack	50
M818R-36	red, flange mount	mfg. pack	50
426-18	grommet	poly pack	12
B426-18	grommet	mfg. pack	100
417-49	hardshell plug	poly pack	6
B417-49	hardshell plug	mfg. pack	100
817-49	molded plug	poly pack	12
B817-49	molded plug	mfg. pack	100

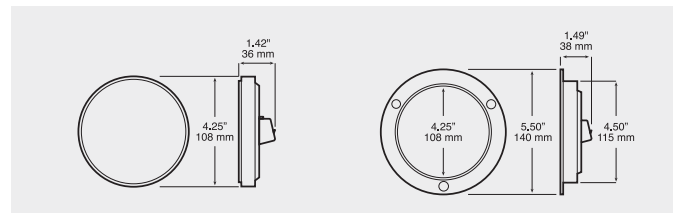

# LED STOP TURN & TAIL



**TRADITIONAL 22 DIODE  
PIRANHA®**



## 821-22/822-22 Piranha® LED Oval Stop/Turn/Tail Light



- Original 22-diode Piranha multi-diode lens look.
- Advanced white diodes behind red lens.
- 822 has flange welded to light, forming a single unit.
- Industry-standard PL3 socket integrated into housing.
- V821KR-22 Viz-Pack kit includes light, grommet and 421-491 plug.
- 9-16 volt operating range.
- Regulated design provides voltage protection and consistent light output over a wide voltage range.
- Meets FMVSS 108 req. in horizontal, vertical or any 360° position.
- See page 39 for matching amber turn signal.

Order No.	Description	Pack	Std Carton
V821R-22	red, grommet	Viz Pack	6
V821KR-22	<b>KIT</b> red, grommet kit	Viz Pack	6
821R-22	red, grommet mount	poly pack	6
822R-22	red, flange mount	poly pack	6
M821R-22	red, grommet mount	mfg. pack	50
M822R-22	red, flange mount	mfg. pack	50
421-18	grommet	poly pack	12
B421-18	grommet	mfg. pack	100
421-491	plug	poly pack	12
B421-491	plug	mfg. pack	100

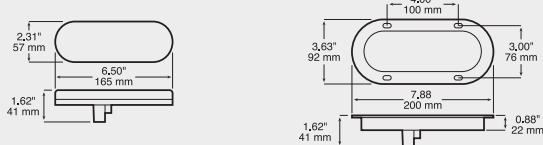

# STOP TURN & TAIL LIGHTS



**TRADITIONAL 22 DIODE  
PIRANHA®**



## 420/423/820-22/823-22 Piranha® LED Oval Stop/Turn/Tail Light



- Original 22-diode Piranha multi-diode lens look.
- AMP-compatible connector integrated into housing.
- Advanced white diodes behind red lens.
- 823-22 has flange welded to light, forming a single unit.
- 420 kit includes light, grommet, and 417-491 adapter harness with PL3 plug.
- 423 kit includes light and 417-491 adapter harness with PL3 plug.
- 9-16 volt operating range.
- Regulated design provides voltage protection and consistent light output over a wide voltage range.
- Meets FMVSS 108 req. in horizontal, vertical or any 360° position.
- See page 39 for matching amber turn signal.



Order No.	Description	Pack	Std Carton
V420KR	<b>KIT</b> red, grommet kit	Viz Pack	6
V423KR	<b>KIT</b> red, flange kit	Viz Pack	6
820R-22	red, grommet mount	poly pack	6
823R-22	red, flange mount	poly pack	6
M820R-22	red, grommet mount	mfg. pack	50
M823R-22	red, flange mount	mfg. pack	50
421-18	grommet	poly pack	12
B421-18	grommet	mfg. pack	100
417-49	hardshell plug	poly pack	6
B417-49	hardshell plug	mfg. pack	100
817-49	molded plug	poly pack	12
B817-49	molded plug	mfg. pack	100
417-491	adapter plug	poly pack	6
B417-491	adapter plug	mfg. pack	100



# STOP TURN & TAIL LIGHTS



**LumenX<sup>®</sup>**  
**IBL**  
2-in-1 PATENTED



## 882-7/883-7 LumenX<sup>®</sup> LED 4" Round Combo Stop, Turn, Tail & Back-Up Light



- Cyclops-style design integrates back-up light into stop/turn/tail light.
- Single bright white diode meets legal back-up light req. used in pairs.
- Available w/ integral AMP-compatible receptacles or hardwired leads.
- -7P versions have hardwired PL3 receptacle.
- Available in 9-16 volt or 9-32 (-MV) operating ranges.
- Does not require "Top" positioning to meet FMVSS 108 standard.
- Kits include B880-49 and B417-49 plugs, plus grommet where req.

Order No.	Description	Pack	Std Carton
882K-7	<b>KIT</b> grommet mount kit	poly pack	6
882K-7-MV	<b>KIT</b> grommet mount kit, multi-volt	poly pack	6
883K-7	<b>KIT</b> flange mount kit	poly pack	6
883K-7-MV	<b>KIT</b> flange mount kit, multi-volt	poly pack	6
M882-7	grommet mount	mfg. pack	50
M882-7-MV	grommet mount, multi-volt	mfg. pack	50
M882-7P	grommet mount, hardwired PL3	mfg. pack	50
M883-7	flange mount	mfg. pack	50
M883-7-MV	flange mount, multi-volt	mfg. pack	50
M883-7P	flange mount, hardwired PL3	mfg. pack	50
426-18	grommet	poly pack	12
B426-18	grommet	mfg. pack	100
417-49	hardshell plug, 3-wire	poly pack	6
B417-49	hardshell plug, 3-wire	mfg. pack	100
880-49	plug, single lead	poly pack	6
B880-49	plug, single lead	mfg. pack	100

See pages 202–207 for additional plug options

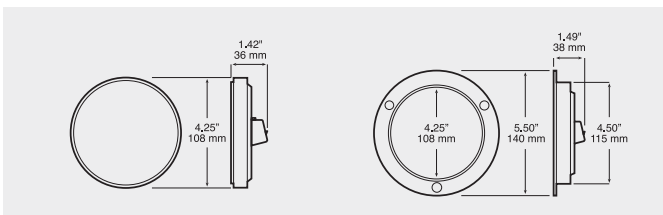

# LED STOP TURN & TAIL



**LumenX<sup>®</sup>**  
**IBL**  
2-in-1 PATENTED



## 880-7/881-7 LumenX<sup>®</sup> LED Oval Combo Stop, Turn, Tail & Back-Up Light



- Cyclops-style design integrates back-up light into stop/turn/tail light.
- Single bright white diode meets legal back-up light req. used in pairs.
- Available w/ integral AMP-compatible receptacles or hardwired leads.
- -7P versions have hardwired PL3 receptacle & blunt-cut back-up lead.
- Available in 9-16 volt or 9-32 (-MV) operating ranges.
- Meets FMVSS 108 req. in horizontal, vertical or any 360° position.

Order No.	Description	Pack	Std Carton
880K-7	<b>KIT</b> grommet mount kit	poly pack	6
880K-7-MV	<b>KIT</b> grommet mount kit, multi-volt	poly pack	6
881K-7	<b>KIT</b> flange mount kit	poly pack	6
881K-7-MV	<b>KIT</b> flange mount kit, multi-volt	poly pack	6
M880-7	grommet mount	mfg. pack	50
M880-7-MV	grommet mount, multi-volt	mfg. pack	50
M880-7P	grommet mount, hardwired PL3	mfg. pack	50
M880-PL3	grommet, hardwired, twin PL3s	mfg. pack	50
M881-7	flange mount	mfg. pack	50
M881-7-MV	flange mount, multi-volt	mfg. pack	50
M881-7P	flange mount, hardwired PL3	mfg. pack	50
421-18	grommet	poly pack	12
B421-18	grommet	mfg. pack	100
417-49	hardshell plug, 3-wire	poly pack	6
B417-49	hardshell plug, 3-wire	mfg. pack	100
880-49	plug, single lead	poly pack	6
B880-49	hardshell plug, single lead	mfg. pack	100

See pages 202–207 for additional plug options

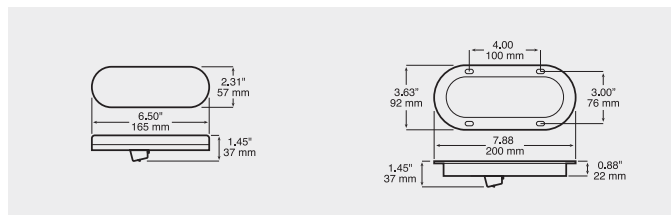

# LED STOP TURN & TAIL



**RECESSED LENS**



## 814/816 Single Diode LED 4" Round Stop/Turn/Tail Light



- Single diode LED light with traditional incandescent lens look.
- AMP-compatible connector integrated into housing.
- 9-16 volt operating range.
- Does not require "Top" positioning to meet FMVSS 108 standard.
- 816R requires 426-18 grommet.
- 814R features gray housing with integral mounting flange.
- 814R flange has recessed lens.
- 417-49 or 817-49 plug required for installation.

Order No.	Description	Pack	Std Carton
816R	grommet mount	poly pack	6
814R	flange mount	poly pack	6
M816R	grommet mount	mfg. pack	50
M814R	flange mount	mfg. pack	50
426-18	grommet	poly pack	12
B426-18	grommet	mfg. pack	100
417-49	hardshell plug	poly pack	6
B417-49	hardshell plug	mfg. pack	100
817-49	molded plug	poly pack	12
B817-49	molded plug	mfg. pack	100

See pages 202–207 for additional plug options

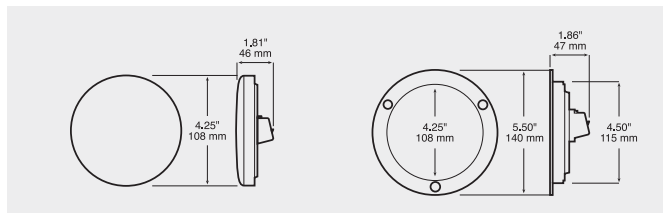

# STOP TURN & TAIL LIGHTS



**RECESSED LENS**



## 824/826 Single Diode LED 4" Round Stop/Turn/Tail Light



- Single diode LED light with traditional incandescent lens look.
- Industry-standard PL3 socket integrated into housing with locking tabs for added plug retention.
- Available in 9-16 volt or 9-32 (-MV) operating ranges.
- Does not require "Top" positioning to meet FMVSS 108 standard.
- 826R requires 426-18 grommet.
- 824R features gray housing with integral mounting flange.
- 824R flange has recessed lens.
- 431-491 plug required for installation.

Order No.	Description	Pack	Std Carton
826R	grommet mount	poly pack	6
824R	flange mount	poly pack	6
826R-MV	grommet mount, multi-volt	poly pack	6
824R-MV	flange mount, multi-volt	poly pack	6
M826R	grommet mount	mfg. pack	50
M824R	flange mount	mfg. pack	50
M826R-MV	grommet mount, multi-volt	mfg. pack	50
M824R-MV	flange mount, multi-volt	mfg. pack	50
426-18	grommet	poly pack	12
B426-18	grommet	mfg. pack	100
431-491	plug	poly pack	12
B431-491	plug	mfg. pack	100

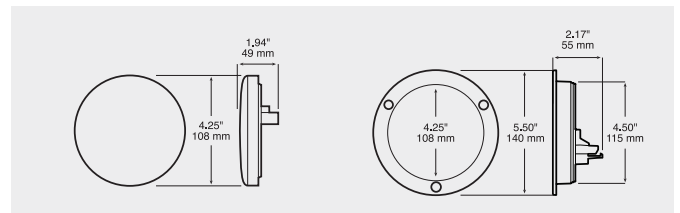

# STOP TURN & TAIL LIGHTS



## 827 Single Diode LED 4" Round Stop/Turn/Tail Light w/ Reflex



- Single diode LED light w/traditional incandescent lens look.
- Features reflector optics around lens periphery, eliminating need to mount and maintain a separate reflector.
- Industry-standard PL3 socket integrated into housing.
- M827FR has flange welded to light, forming a single unit.
- 9-16 volt operating range.
- Does not require "Top" positioning to meet FMVSS 108 standard.
- Requires 426-18 grommet and 431-491 plug for installation.
- 827KR kit contains mounting grommet and connecting plug.
- **NOTE:** Less than 75 sq. cm of effective, projected luminous lens area. For use on vehicles under 80" wide unless used in pairs per side.

Order No.	Description	Pack	Std Carton
827R	red with reflex	poly pack	6
827KR	<b>KIT</b> red with reflex, kit	poly pack	12
M827R	red with reflex	mfg. pack	50
M827FR	red with reflex, flange mount	mfg. pack	50
426-18	grommet	poly pack	12
B426-18	grommet	mfg. pack	100
431-491	plug	poly pack	12
B431-491	plug	mfg. pack	100

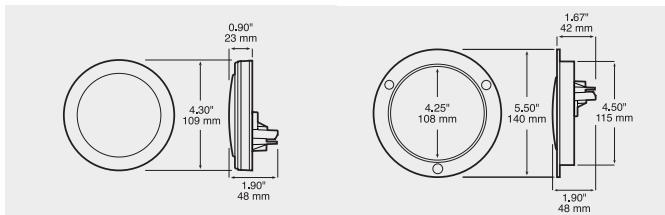

# LED STOP TURN & TAIL



## 829-7 LumenX® LED 4" Round Stop/Turn/Tail Light w/ Reflex



- White diodes behind red lens.
- Optically advanced design fully illuminates lens.
- Industry-standard PL3 socket integrated into housing.
- Flange with reflector optics integrated into lens, eliminating need for separate reflector.
- 9-16 volt operating range.
- Regulated design provides voltage protection and consistent light output over a wide voltage range.
- Does not require "Top" positioning to meet FMVSS 108 standard.
- Includes protective gasket.
- See page 98 for matching 829C-7 back-up light.

Order No.	Description	Pack	Std Carton
829R-7	flange mount with reflex	poly pack	6
M829R-7	flange mount with reflex	mfg. pack	50
431-491	plug	poly pack	12
B431-491	plug	mfg. pack	100

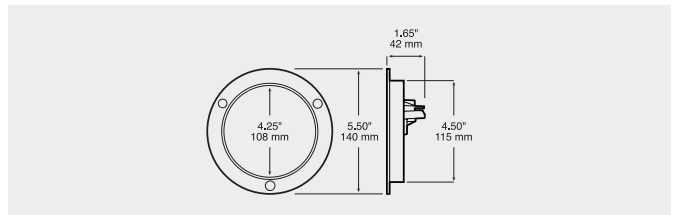

# LED STOP TURN & TAIL



**817/818CR-2 LED**  
4" Round Stop/Turn/Tail Light



- Features red diodes behind clear lens.
- AMP-compatible connector integrated into housing.
- 9-32 volt operating range is compatible with 12V and 24V vehicles.
- 817CR-2 has skirted weld joint for added protection against moisture.
- 818CR-2 has flange welded to light, forming a single unit.
- See page 40 for matching amber turn signal.
- New design 817CR-9 & 818CR-9 coming soon.

Order No.	Description	Pack	Std Carton
817CR-2	10 diodes w/ clear lens	poly pack	6
818CR-2	10 diodes w/ clear lens, flange	poly pack	6
M817CR-2	10 diodes w/ clear lens	mfg. pack	50
M818CR-2	10 diodes w/ clear lens, flange	mfg. pack	50
426-18	grommet	poly pack	12
B426-18	grommet	mfg. pack	100
417-49	hardshell plug	poly pack	6
B417-49	hardshell plug	mfg. pack	100

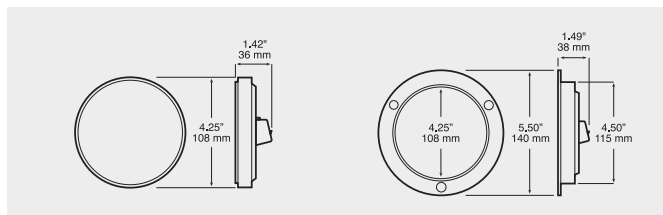

# STOP TURN & TAIL LIGHTS



**817CR-3 LED**  
4" Round Stop/Turn/Tail Light



- Features red diodes behind clear lens.
- AMP-compatible connector integrated into housing.
- 9-16 volt operating range.
- Skirted weld joint for added protection against moisture.

Order No.	Description	Pack	Std Carton
M817CR-3	7 diodes w/ clear lens	mfg. pack	50
426-18	grommet	poly pack	12
B426-18	grommet	mfg. pack	100
417-49	hardshell plug	poly pack	6
B417-49	hardshell plug	mfg. pack	100

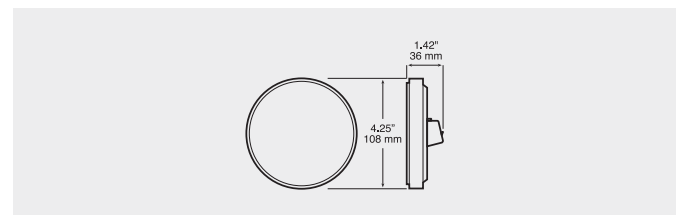

ST  
TURN  
MARKER  
B-U/UTIL  
SPEC  
EMERG  
ECE  
MOUNT  
ELECT  
REFLECT  
ACCY  
MERCH  
TECH



## TRADITIONAL 36 DIODE PIRANHA®



### 817CR-36/818CR-36 Piranha® LED 4" Round Stop/Turn/Tail Light



- Features red diodes behind clear lens.
- AMP-compatible connector integrated into housing.
- 9–16 volt operating range.
- 817CR-36 has skirted weld joint for added protection against moisture.
- 818CR-36 has flange welded to light, forming a single unit.
- Viz-Pack kit includes light, grommet and 417-49 plug.

Order No.	Description	Pack	Std Carton
V817KCR-36	<b>KIT</b> red, grommet mount	Viz Pack	6
817CR-36	red, grommet mount	poly pack	6
818CR-36	red, flange mount	poly pack	6
M817CR-36	red, grommet mount	mfg. pack	50
M818CR-36	red, flange mount	mfg. pack	50
426-18	grommet	poly pack	12
B426-18	grommet	mfg. pack	100
417-49	hardshell plug	poly pack	6
B417-49	hardshell plug	mfg. pack	100

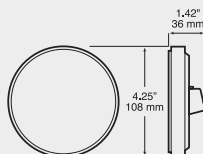

### 869 LED LED Thin-Line Stop/Turn/Tail Light



- Meets DOT requirements vertically, horizontally or at 45 degree angle.
- Thin-line design fits narrow channel applications.
- Perfect for light- and medium-duty enclosed trailers.
- Hardwired design eliminates the need for separate plug and reduces connection points.
- 9–16 volt operating range.
- Mounts on 14 1/4" centers.

Order No.	Description	Pack	Std Carton
869R	red	poly pack	6
M869R	red	mfg. pack	50

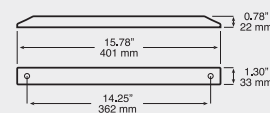



# LED STOP TURN & TAIL



## 418R-4 LED Surface Mount 4" Round Stop Turn & Tail Light

**10** diodes **HARD WIRED**

- 9-16 volt operating range.
- Hardwired design eliminates the need for separate plug and reduces connection points.
- Surface mounting for quick and versatile installation.
- Accessory snap-on chrome bezel available.

Order No.	Description	Pack	Std Carton
418R-4	red surface mount	poly pack	6
M418R-4	red surface mount	mfg. pack	50
B418-10	chrome bezel	mfg. pack	50

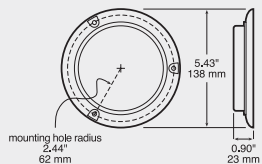

# STOP TURN & TAIL LIGHTS



## 423-4 LED Surface Mount Oval Stop/Turn/Tail Light

**10** diodes **VIZ PACK** **HARD WIRED** **MV** Multi-Volt 12V & 24V

- Meets FMVSS 108 requirements when mounted horizontally or vertically.
- 9-32 volt operating range. (Viz-Pack version 12V only)
- Hardwired design eliminates the need for separate plug and reduces connection points.
- Surface mounting for quick and versatile installation.
- Decorative snap-on chrome bezel is included with Viz Pack kit or available as accessory for manufacturer pack.
- Amber auxiliary turn signal version also available. See page 44.
- White auxiliary light version also available. See page 119.

Order No.	Description	Pack	Std Carton
V423XR-4	<b>KIT</b> 12V red kit with bezel	Viz Pack	3
423R-4	multi-volt red	poly pack	6
M423R-4	multi-volt red	mfg. pack	50
423-11	chrome bezel	poly pack	12
B423-11	chrome bezel	mfg. pack	50

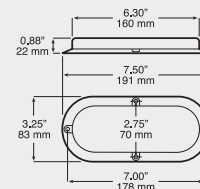

ST

TURN

MARKER

B-U/UTIL

SPEC

EMERG

ECE

MOUNT

ELECT

REFLECT

ACCY

MERCH

TECH



**717 LED**  
7" Bus & Transit Stop/Turn/Tail Light



- Round, 7-inch size popular for bus and transit applications.
- Sealed potted design.
- 9–32 volt operating range.
- Surface mount with standard 4-hole mounting pattern.
- Comes standard with mounting gasket providing additional protection between lamp and mounting surface.
- Hardwired leads are terminated with two .180 male bullets and one ring terminal for ground.
- Features reflex optics on lens eliminating need to mount and maintain a separate reflector.
- Matching amber turn signal available on page 44.
- Matching white back-up light available on page 99.

Order No.	Description	Pack	Std Carton
717R	surface mount	poly pack	20

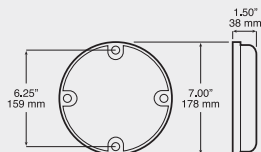

**850-1 LED**  
Rectangular Stop/Turn/Tail Light

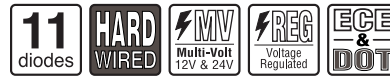

- Certified to meet both FMVSS 108 (USA) & ECE (European) requirements in horizontal or vertical position.
- Sealed lens and housing meets IP67 ingress protection level.
- 9–32 volt operating range.
- Hardwired design eliminates the need for separate plug and reduces connection points.
- 850R has 6.5' leads, others have 300mm (11.8") leads.
- 850R-1P has hardwired PL3 plug.
- Matching amber turn signal available on page 44.
- Matching white back-up light available on page 99.

Order No.	Description	Pack	Std Carton
P850R-1	red, 12" leads	poly pack	6
850R	red, 6.5ft sheathed leads	mfg. pack	10
850R-1	red, 12" leads	mfg. pack	10
850R-1P	red, 12" leads w/ PL3 plug	mfg. pack	10
850-18	rubber grommet	poly pack	12
B850-18	rubber grommet	mfg. pack	100

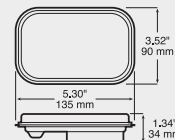

# LED STOP TURN & TAIL



4-pin plug

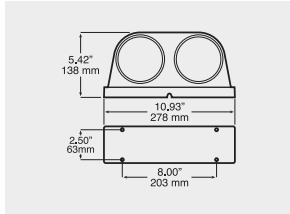

# STOP TURN & TAIL LIGHTS

## 318 LED Agricultural Stop, Tail, Turn & Warning Light

**44** diodes **HARD WIRED**

- ASAE S279.17 compliant.
- Perfect for all agricultural applications.
- Combination lights function as both red stop and tail light and amber turn signal and flashing warning light.
- Works with all 12-volt vehicles.
- Can be mounted to vertical or horizontal surfaces.
- Available with stripped leads or 4-pin plug for easy installation.

Order No.	Description	Pack	Std Carton
318L	roadside, stripped leads	mfg. pack	16
318L-P	roadside, 4-pin plug	mfg. pack	16
318L-AMP	roadside, hardshell connector	mfg. pack	16
318R	curbside, stripped leads	mfg. pack	16
318R-P	curbside, 4-pin plug	mfg. pack	16
318R-AMP	curbside, hardshell connector	mfg. pack	16

## 319 LED Agricultural Stop/Turn/Tail Light

**12** diodes **HARD WIRED**

- ASAE S279.17 compliant.
- Perfect for all agricultural applications.
- Single-sided red stop and tail light.
- Works with all 12-volt vehicles.
- Can be mounted to vertical or horizontal surfaces.
- Stripped leads for easy installation.
- See matching 319AA amber turn signal/warning light on page 43.

Order No.	Description	Pack	Std Carton
319R	red, stripped leads	mfg. pack	24

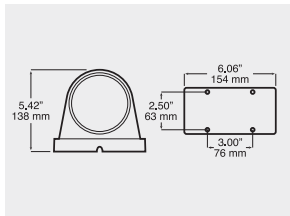

## 339 LED Round Single-Face Pedestal Stop/Turn/Tail Light

**24** diodes **VIZ PACK** **HARD WIRED**

- Single stud pedestal mount.
- 3-wire electrical connection.
- Single 4" round acrylic lens.
- Chrome die-cast housing.
- 339R-DEU has hardwired Deutsch-style connector
- Matching 338-2 amber/red and 339A amber turn signals available on page 42.

Order No.	Description	Pack	Std Carton
V339R	red	Viz Pack	6
M339R	red	mfg. pack	24
M339R-DEU	red, hardwired connector	mfg. pack	24

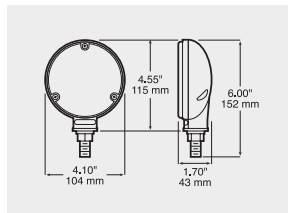

ST  
TURN  
MARKER  
B-U/UTIL  
SPEC  
EMERG  
ECE  
MOUNT  
ELECT  
REFLECT  
ACCY  
MERCH  
TECH

# STOP TURN & TAIL LIGHTS



## 840 LED Under 80" Wide Combination Rear Light



- Combination LED stop, turn and tail light.
- Solid state construction—no bulbs to break or burn out.
- Fully sealed, submersible construction.
- Potted circuitry protects against moisture, corrosion, and vibration.
- Lower amp draw than incandescent lights.
- Designed to directly replace 440-series incandescent lights.
- M840L roadside light includes license light.
- Integral, dedicated side marker.
- Exceeds all DOT rear lighting and reflex requirements for trailers less than 80" wide.

Order No.	Description	Pack	Std Carton
V840	without license light	Viz Pack	6
V840L	with license light	Viz Pack	6
840	without license light	poly pack	6
840L	with license light	poly pack	6
M840	without license light	mfg. pack	24
M840L	with license light	mfg. pack	24

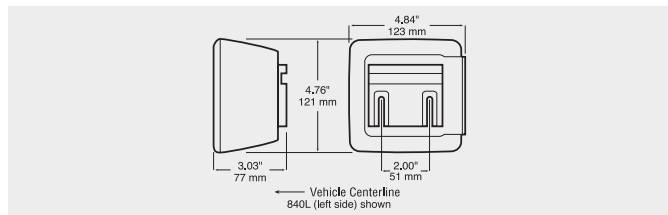

# LED COMBINATION REAR LIGHTS



## 844 LED Low Profile Over 80" Wide Combination Rear Light



- Combination LED stop, turn and tail light.
- Fully sealed, submersible construction.
- Low profile, durable design.
- M844L roadside light includes license light.
- Exceeds all DOT rear lighting and reflex requirements for all trailers, including those 80" wide and over.
- Advanced lens optics for an evenly lit appearance.
- M844-BT3 has leads terminated with three .180 bullet connectors.
- Replacement lenses available.

Order No.	Description	Pack	Std Carton
V844	without license light	Viz Pack	6
V844L	with license light	Viz Pack	6
844	without license light	poly pack	6
844L	with license light	poly pack	6
M844	without license light	mfg. pack	24
M844-BT3	without license light, .180 bullets	mfg. pack	24
M844L	with license light	mfg. pack	24
844-252	rear lens	poly pack	10
844-253	side lens	poly pack	10

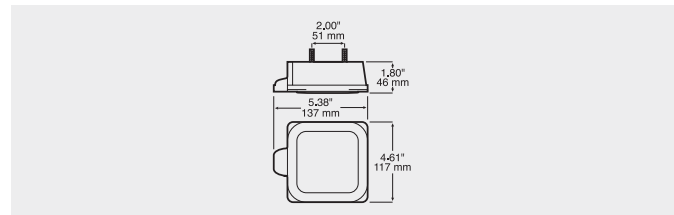

# LED COMBINATION REAR LIGHTS



## 845 LED Over 80" Wide Combination Rear Light w/ Back-Up



- Combination stop, turn, tail and back-up light with integral reflex.
- "L" version includes LED license light.
- Potted LED circuitry protects against moisture and road-shock.
- Popular 3-stud mounting design fits a wide range of applications.

Order No.	Description	Pack	Std Carton
V845	without license light	Viz Pack	6
V845L	with license light	Viz Pack	6
845	without license light	box	12
845L	with license light	box	12

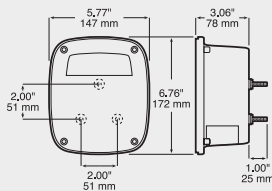

# STOP TURN & TAIL LIGHTS



## 856 LED Rectangular Over 80" Wide Combination Rear Light



- Combination LED stop, turn and tail light.
- Solid state construction—no bulbs to break or burn out.
- Fully sealed, submersible construction.
- Potted circuitry protects against moisture, corrosion, and vibration.
- Lower amp draw than incandescent lights.
- Designed to directly replace 456-series incandescent lights.
- M856L roadside light includes license light.
- Integral, dedicated side marker diode.
- Carriage mounting bolts included.
- Exceeds all DOT rear lighting and reflex requirements for all trailers, including those 80" wide and over.

Order No.	Description	Pack	Std Carton
V856	without license light	Viz Pack	6
V856L	with license light	Viz Pack	6
856	without license light	poly pack	6
856L	with license light	poly pack	6
M856	without license light	mfg. pack	30
M856L	with license light	mfg. pack	30

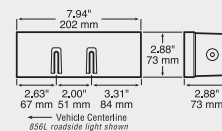



## 941 LED

### Under 80" Wide Trailer Rear Light Kit



- Submersible LED rear lighting kit for trailers under 80" wide.
- Includes one each of our 840/840L LED tail lights plus 20' trailer harness, license bracket, mounting hardware, and installation instructions.
- Front side marker lights and side reflectors are necessary to meet DOT requirements.
- Replacement harness available separately.
- Attractive, secure visual pack.

Order No.	Description	Pack	Std Carton
V941	<b>KIT</b> LED rear light kit	Viz Pack	2



## 944 LED Low Profile

### Over 80" Wide Rear Trailer Light Kit



- Submersible LED rear lighting kit for all trailers, including those 80" wide and over.
- Includes one each of our 844/844L LED tail lights plus 25' trailer harness, license bracket, mounting hardware, and installation instructions.
- Front side marker lights, ID lights and side reflectors are necessary to meet DOT requirements.
- Low profile design.
- Advanced lens optics for an evenly lit appearance.

Order No.	Description	Pack	Std Carton
V944	<b>KIT</b> LED trailer light kit	Viz Pack	2
844-252	replacement rear lens	poly pack	10
844-253	replacement side lens	poly pack	10



## 947 LED

### Over 80" Wide Rear Trailer Light Kit



- Submersible rear lighting kit for all trailers 80" wide and over.
- Includes one each of our low profile 856/856L LED tail lights plus license bracket, mounting hardware, and installation instructions.
- Provides rear lighting and reflectors. Front side clearance/marker lights, side reflectors, and rear identification lights are necessary to meet all DOT requirements.
- Replacement harness available separately.

Order No.	Description	Pack	Std Carton
V947	<b>KIT</b> LED rear light kit	Viz Pack	4



## 306 Surface-Mount Stop/Turn/Tail Light



- Rectangular, surface-mount light functions as rear S/T/T light.
- For use on vehicles under 80" wide; has less than 75 sq. cm of effective, projected luminous lens area.
- Features polycarbonate lens, galvanized steel base plate, dual-filament bulb, and tough plastic guard to protect lead wires.
- Mounts on 3 1/2" centers and grounds through mounting screw.
- See matching 306A turn signal on page 49.
- See matching 393C back-up light on page 100.

Order No.	Description	Pack	Std Carton
V306R	red	Viz Pack	6
306R	red	poly pack	24
306-25R	red lens	poly pack	10
413-07	replacement pigtail	poly pack	25
2057	12 volt replacement bulb		<i>reference only</i>

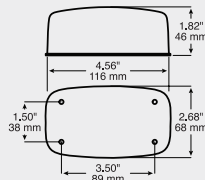

## 313-2 Single-Face Pedestal Stop/Turn/Tail Light



- Pedestal-mount, single-face light functions as S/T/T light.
- Durable, black plastic housing with snap-on red acrylic lens.
- Two lead wires exit through 1/2" diameter hollow mounting stud.
- Grounds through mounting stud.
- Interchangeable with competitive units.

Order No.	Description	Pack	Std Carton
V313-2	red	Viz Pack	6
313-2	red	poly pack	12
M313-2	red	mfg. pack	48
313-15R	red lens	poly pack	10
313-15BLK	black lens cover	poly pack	10
413-07	replacement pigtail	poly pack	25
2057	replacement bulb		<i>reference only</i>

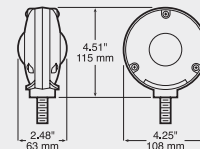

# STOP TURN & TAIL LIGHTS



4-pin plug

3-pin plug

## 308/309 Agricultural Stop/Turn/Tail & Warning Lights



- ASAE S279.17 compliant.
- Perfect for all agricultural applications.
- 308 combination lights function as both red stop and tail light and amber turn signal and flashing warning light.
- Single-sided red version functions as stop and tail light.
- Works with all 12-volt vehicles.
- Can be mounted to vertical or horizontal surfaces.
- Rubber protective gasket seals unit from moisture and dust
- Replaceable bulb and lens.
- Standard version has 4-pin plug (308) or 3-pin plug (309) for easy installation.
- -PKD versions are terminated with Packard-style hardshell connector.
- Replacement lens kits include replacement gasket and screws.
- See matching 309AA double-sided amber turn signal/warning light on page 52. See 318 & 319 series LED version on page 17.

Order No.	Description	Pack	Std Carton
308L	dual, roadside	mfg. pack	16
308L-PKD	dual, roadside w/ hardshell connector	mfg. pack	16
308R	dual, curbside	mfg. pack	16
308R-PKD	dual, curbside w/ hardshell connector	mfg. pack	16
309R	red, single	mfg. pack	24
308-15A	amber replacement lens kit	poly pack	50
308-15R	red replacement lens kit	poly pack	50
308-15BLK	black block-off cover	poly pack	50

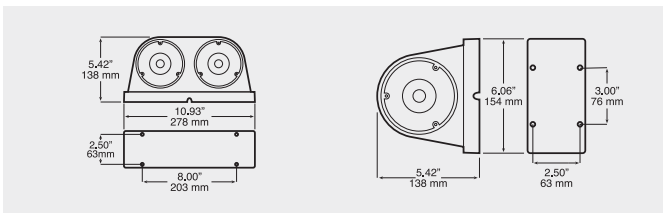

# INCANDESCENT STOP TURN & TAIL



413

413-3

## 413 Flush-Mount 4" Stop/Turn/Tail Light



- Double-wire, flush-mount 4" round light functions as S/T/T light.
- Black polycarbonate housing.
- 413-3 has reflector optics, eliminating need for separate reflector.
- Grounds through mounting screws.
- **NOTE:** Less than 75 sq. cm of effective, projected luminous lens area. For use on vehicles under 80" wide unless used in pairs per side.

Order No.	Description	Pack	Std Carton
V413	red	Viz Pack	6
413	red	poly pack	12
M413	red	mfg. pack	48
M413-3	red w/ reflector	mfg. pack	48
V410-15R	red lens	Viz Pack	12
410-15R	red lens	poly pack	10
411-24	mounting gasket	poly pack	1
415-15R	red reflector lens	poly pack	10
410-21	galvanized retainer ring	poly pack	25
425S-21	SS retainer ring	poly pack	25
413-07	replacement pigtail	poly pack	25
1157	replacement bulb		reference only

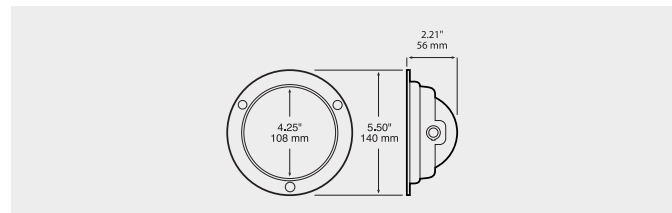



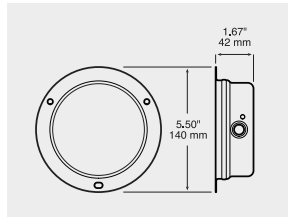

## 413S

### Stainless Flush-Mount 4" Stop/Turn/Tail Light



- Double-wire, flush-mount 4" round light functions as S/T/T light.
- Stainless-steel housing and retainer ring.
- Grounds through mounting screws.
- Refer to replacement and installation parts listed for 413 series on facing page.

Order No.	Description	Pack	Std Carton
M413S	stainless-steel, red	mfg. pack	48
425S-21	SS retainer ring	poly pack	25

## 421 Sealed

### Oval Stop/Turn/Tail Light

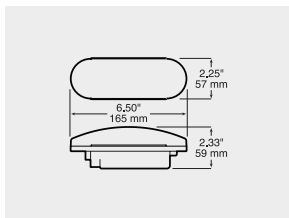

- Sealed, oval stop, turn, and tail light may be used on both curbside and roadside of vehicle or trailer.
- Legal in either horizontal or vertical position.
- Polycarbonate lens is welded to housing to form single unit.
- Requires mounting grommet and 3-wire plug to complete installation.
- 421H surface mount light available for easy mounting.
- See 421A turn signal, and 416 back-up light for companion models.
- Kits include light, grommet, and right-angle plug.
- 12-volt lamps designed with dual-filament, 2.1/.59 amp, 32/3 cp bulb.
- Grommet versions may be mounted using accessory 421-09 metal bracket shown.

Order No.	Description	Pack	Std Carton
V421R	red	Viz Pack	6
V421KR	<b>KIT</b> red kit	Viz Pack	3
421R	red	poly pack	12
421KR	<b>KIT</b> red kit	poly pack	12
M421R	red	mfg. pack	48
M421KR	<b>KIT</b> red kit	mfg. pack	48
M421HR	red, surface-mount	mfg. pack	48
421-18	grommet	poly pack	12
B421-18	grommet	mfg. pack	100
421-491	right angle plug	poly pack	12
B421-491	right angle plug	mfg. pack	100
431-491	plug	poly pack	12
B431-491	plug	mfg. pack	100
421-09	mounting bracket	box	6

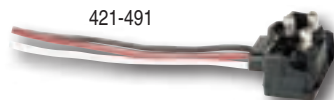

M421HR

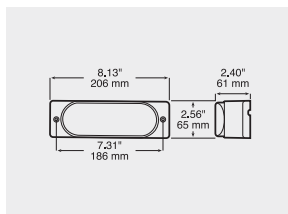

421-09 bracket  
See page 186.

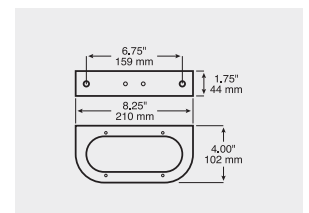



## 424/431 Sealed 4" Round Stop/Turn/Tail Light



- Sealed, 4" round stop, turn, and tail light.
- Fully automated manufacturing process ensures consistent quality.
- Features extra wide, spin-welded, tongue-and-groove lens seal.
- 424R features one-piece integral gray housing and flange.
- High performance steel conductors reduce possibility of wire failure.
- Wedge-base socket prevents premature bulb failure.
- 431KR kit includes light, grommet and 431-491 straight plug.
- See page 11 for 824/826 LED version.

Order No.	Description	Pack	Std Carton
431R	red, grommet mount	poly pack	12
M431R	red, grommet mount	mfg. pack	50
M431KR	<b>KIT</b> red, grommet mount kit	mfg. pack	50
M424R	red, flange mount	mfg. pack	48
426-18	grommet	poly pack	12
B426-18	grommet	mfg. pack	100
431-491	plug	poly pack	12
B431-491	plug	mfg. pack	100

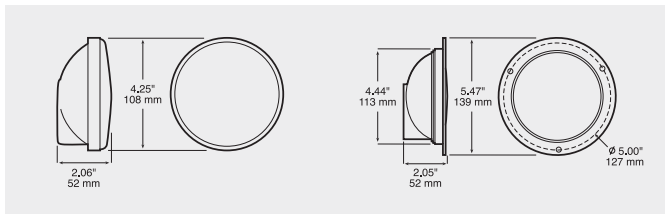

## 425 Flush-Mount 4" Round Stop/Turn/Tail Light



- Double-wire, flush-mount 4" round S/T/T light.
- 425 series features heavy-gauge steel housing with black powder-coated finish.
- 425S light features stainless-steel housing and retainer ring.
- Fits in 4 1/2" hole and secures with three screws or rivets.

Order No.	Description	Pack	Std Carton
425	red	poly pack	12
425S	stainless-steel, red	poly pack	12
M425	red	mfg. pack	48
M425S	stainless-steel, red	mfg. pack	48
410-15R	red lens	poly pack	10
411-24	mounting gasket	mfg. pack	10
410-21	galvanized retainer ring	poly bag	25
425S-21	SS retaining ring	poly bag	25
413-07	replacement pigtail	poly pack	25
1157	replacement bulb		<i>reference only</i>

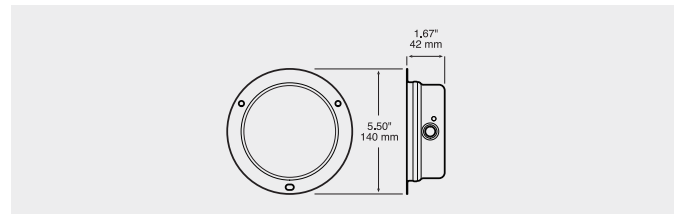



## 426 Sealed Long-Life Round 4" Stop/Turn/Tail Light



- Fully automated manufacturing process ensures consistent quality.
- Features extra wide, spin-welded, tongue-and-groove lens seal.
- 12-volt lamps feature dual-filament, long-life 2.1/59 amp, 32/3 cp heavy-duty, long-life bulb.
- Long life, wedge-base socket prevents premature bulb failure.
- 426 lights require mounting grommet and 3-wire plug.
- Kits include 426R light, grommet, and 431-491 straight plug.
- Viz-Pack versions have gray housing.
- See 426A turn signal, and 415 back-up light for companion models.
- Can be flange-mounted with use of 424-09 black snap-on flange. See page 185 for details.
- See page 11 for 826R & 826R-MV single-diode LED equivalent.

Order No.	Description	Pack	Std Carton
V426R	red	Viz Pack	6
V426KR	<b>KIT</b> red kit	Viz Pack	3
426R	red	poly pack	12
426KR	<b>KIT</b> red kit	poly pack	12
M426R	red	mfg. pack	48
M426KR	<b>KIT</b> red kit	mfg. pack	48
424-09	snap-on mounting flange	poly pack	24
426-18	grommet	poly pack	12
B426-18	grommet	mfg. pack	100
431-491	plug	poly pack	12
B431-491	plug	mfg. pack	100

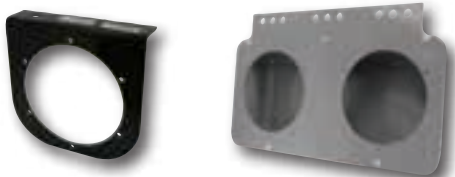

See pages 184–185 for additional mounting options.

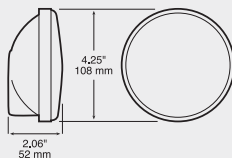

## 429 Sealed 4" Round Stop/Turn/Tail Light w/ Clear Rear Housing



- Sealed, 4" round stop, turn, and tail light.
- Clear back is ideal to illuminate service body compartments.
- Fully automated manufacturing process ensures consistent quality.
- Features extra wide, spin-welded, tongue-and-groove lens seal.
- High performance steel conductors reduce possibility of wire failure.
- Wedge-base socket prevents premature bulb failure.
- Requires mounting grommet and 3-wire plug.

Order No.	Description	Pack	Std Carton
429R	clear back	poly pack	12
M429R	clear back	mfg. pack	48
424-09	snap-on mounting flange	poly pack	24
426-18	grommet	poly pack	12
B426-18	grommet	mfg. pack	100
431-491	plug	poly pack	12
B431-491	plug	mfg. pack	100

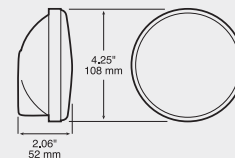

STT

TURN

MARKER

B-U/UTIL

SPEC

EMERG

ECE

MOUNT

ELECT

REFLECT

ACCY

MERCH

TECH

# STOP TURN & TAIL LIGHTS



## 428 Universal Stud-Mount Stop/Turn/Tail Light

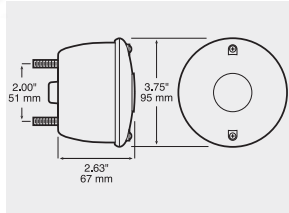

- Stud-mount, combination tail light that functions as stop, turn, tail, and license light (428 only).
- Features 3-3/4" diameter wrap-over lens retained by two screws, black plastic housing, and two 10" lead wires.
- Mounts with two 1/4" studs on 2" centers.
- Grounds through mounting hardware.
- NOTE: Less than 75 sq. cm of effective, projected luminous lens area. For use on vehicles under 80" wide unless used in pairs per side.

Order No.	Description	Pack	Std Carton
V428	with license light	Viz Pack	3
V428S	without license light	Viz Pack	6
428	with license light	box	24
428S	without license light	box	24
M428	with license light	mfg. pack	60
M428S	without license light	mfg. pack	60
V420-15	red replacement lens 2-pack	Viz Pack	12
420-15	red replacement lens	poly pack	10
413-07	replacement pigtail	poly pack	25
1157	replacement bulb		<i>reference only</i>

## 450R Sealed Rectangular Stop/Turn/Tail Light



- Sealed, 3"x 5" red stop, turn and tail light.
- Popular on commercial vehicles; replaces competitive rectangular lights.
- Kit includes light, grommet, and plug.
- Can be matched with 450A amber turn signal on page 49.

Order No.	Description	Pack	Std Carton
450KR	<b>KIT</b> red kit	poly pack	20
M450R	red	mfg. pack	50
450-18	grommet	poly pack	12
B450-18	grommet	mfg. pack	100
421-491	3-wire plug	poly pack	12
B421-491	3-wire plug	mfg. pack	100

# INCANDESCENT STOP TURN & TAIL



## 419 Rectangular Combination Rear Light



- Red lens provides stop and tail functions, while amber lens serves as turn signal or flashing warning light.
- Popular OEM lamp for use on construction and agricultural equipment.
- Designed for use on vehicles under or over 80" wide.
- Two screws securely hold each lens and allow for easy bulb replacement.
- Lens gasket seals out moisture and extends bulb life.
- Mounts easily with two 5mm studs on 2 7/8" centers.
- Meets ECE requirements.

Order No.	Description	Pack	Std Carton
M419	red/amber	mfg. pack	36
419-25A	amber lens	poly pack	10
419-25R	red lens	poly pack	10
P21/5W 12V	replacement bulb stop & tail		<i>reference only</i>
12498	replacement bulb turn signal		<i>reference only</i>

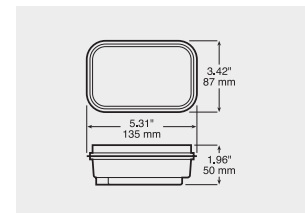
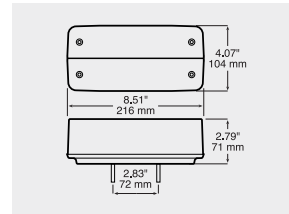

ST

TURN

MARKER

B-U/UTIL

SPEC

EMERG

ECE

MOUNT

ELECT

REFLECT

ACCY

MERCH

TECH

## 442

### Universal Three-Stud Combination Rear Light



- Universal, OEM-style replacement tail light for Chevrolet, GMC, Ford, and International.
- Features three 1/4" diameter mounting studs with 2" triangular pattern.
- Junction box has universal terminals.
- Interchangeable with competitive models as follows:
- 442: Chevrolet/GMC 715104, 795059 (right side);  
Ford D9HA13405B; IH 467708 C91, 424539 C91, 590158 C91
- 442L: Chevrolet/GMC 715103, 795058 (left side);  
Ford D8HZ13404A; IH 467707 C91, 424538 C91, 590157 C91

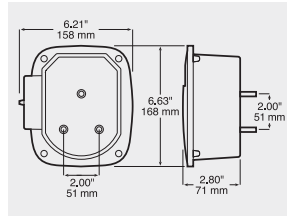

Order No.	Description	Pack	Std Carton
442	curbside	box	12
442L	roadside	box	12
445-25	replacement lens	poly pack	10
1157	replacement bulb (stop & tail)		reference only
1156	replacement bulb (back-up)		reference only

## 445

### Universal Three-Stud Combination Rear Light



- Universal stud-mount combination tail light.
- Includes stop, turn, tail, back-up and license light functions.
- Features three 1/4" diameter mounting studs with 2" triangular pattern.
- Connects through 3 wire loom, grounds through mounting studs.
- OEM replacement for Peterbilt, Mack, White, and Jeep trucks.
- Services GM P/N 15613944 & 15565732, Navistar P/N 166282C91. Similar to Grote P/N 53702 and 5312.

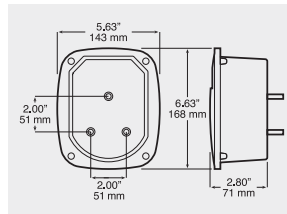

Order No.	Description	Pack	Std Carton
V445	with license light	Viz Pack	6
445	with license light	box	12
445-25	replacement lens	poly pack	10
1157	replacement bulb (stop & tail)		reference only
1156	replacement bulb (back-up)		reference only

## 454

### Mack Replacement Combination Rear Light



- Features two 1/4" studs mounted on 2" centers and built-in license light.
- Connects through 39", 3 wire loom, grounds through mounting studs.
- Design permits both left-and right-side installation.
- Replaces Mack numbers 14M0444RP1 and 14M0444RP4.

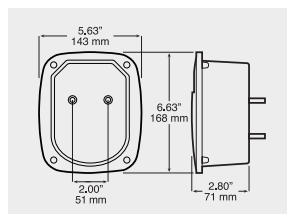

Order No.	Description	Pack	Std Carton
454	with license light	box	12
445-25	replacement lens	poly pack	10
1157	replacement bulb (stop & rail)		reference only
1156	replacement bulb (back-up)		reference only



## 440 Under 80" Combination Rear Light



- Combination rear light for vehicles and trailers under 80" wide.
- Includes the following functions: stop, turn, tail, rear reflex, side marker, side reflex, and license light ("L" suffix only).
- Viz Pack and poly pack units include lead wire.
- Manufacturers pack features push-in connections with two extra ports for additional lights.
- Mounts on 2" centers and includes mounting hardware.
- Grounds through 1/4" mounting studs.
- V440-15 lens kit contains two lenses: 440-15 & 55-15R.

Order No.	Description	Pack	Std Carton
V440	without license light	Viz Pack	6
V440L	with license light	Viz Pack	6
440	without license light	box	12
440L	with license light	box	12
M440	without license light	mfg. pack	48
M440L	with license light	mfg. pack	48
V440-15	lens kit	Viz Pack	12
440-15	stop & tail lens	poly pack	10
55-15R	side marker lens	poly pack	10
1157	replacement bulb (stop & tail)		<i>reference only</i>
168	replacement bulb (side)		<i>reference only</i>

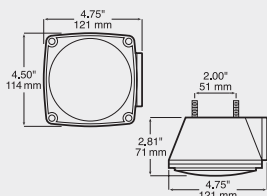

## 441 Under 80" Submersible Combination Rear Light



- Combination rear light for vehicles and trailers under 80" wide.
- Includes the following functions: stop, turn, tail, rear reflex, side marker, side reflex, and license light ("L" suffix only).
- Features gaskets on both rear and side lenses with brown and yellow or green lead wires.
- Mounts on 2" centers and includes mounting hardware.
- Grounds through 1/4" mounting studs.
- V440-15 lens kit contains two lenses: 440-15 & 55-15R.

Order No.	Description	Pack	Std Carton
M441	without license light	mfg. pack	48
M441L	with license light	mfg. pack	48
V440-15	lens kit	Viz Pack	12
440-15	stop & tail lens	poly pack	10
55-15R	side marker lens	poly pack	10
1157	replacement bulb (stop & tail)		<i>reference only</i>
1895	replacement bulb (side)		<i>reference only</i>

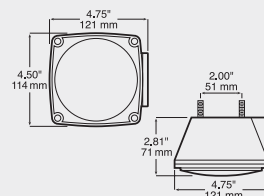

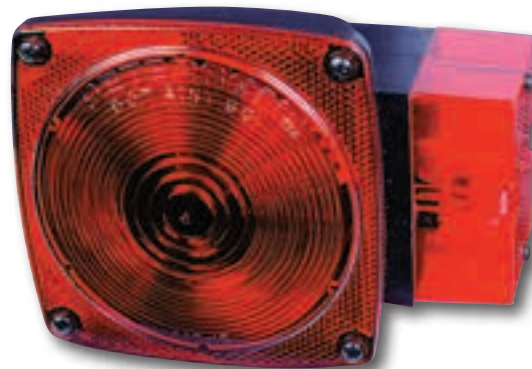

## 444 Over 80" Wide Combination Rear Light



- Combination rear light for vehicles and trailers 80" or more in width.
- Includes the following functions; stop, turn, tail, rear clearance, rear reflex, side marker, side reflex, and license light ("L" suffix).
- Features push-in connections with two extra ports for additional lights.
- Grounds through mounting studs.
- Mounts on 2" centers and includes mounting hardware.
- Units manufactured prior to April 2012 have the side marker lens attached with screws. Newer units use a snap-on lens. When ordering replacement side marker lenses, be sure to specify the appropriate style lens.

Order No.	Description	Pack	Std Carton
M444	without license light	mfg. pack	48
M444L	with license light	mfg. pack	48
440-15	stop & tail lens	poly pack	10
56-15R	side marker lens (screw type)	poly pack	10
444-151R	side marker lens (snap-on type)	poly pack	10
1157	replacement bulb (stop & tail)	<i>reference only</i>	
194/193	replacement bulb (side)	<i>reference only</i>	

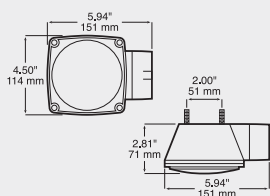

## 452 Over 80" Wide Submersible Combo Rear Light



- Combination rear light for vehicles and trailers 80" or more in width.
- Includes the following functions: stop, turn, tail, rear clearance, rear reflex, side marker, side reflex, and license light ("L" suffix).
- Features gaskets on both rear and side lenses.
- Grounds through mounting studs.
- Mounts on 2" centers.
- Includes mounting hardware.

Order No.	Description	Pack	Std Carton
V452	without license light	Viz Pack	3
V452L	with license light	Viz Pack	3
M452	without license light	mfg. pack	48
M452L	with license light	mfg. pack	48
440-15	stop & tail lens	poly pack	10
56-15R	side marker lens	poly pack	10
1157	replacement bulb (stop & tail)	<i>reference only</i>	
194/193	replacement bulb (side)	<i>reference only</i>	

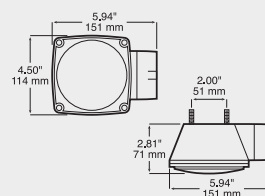

STT

TURN

MARKER

B-U/UTIL

SPEC

EMERG

ECE

MOUNT

ELECT

REFLECT

ACCY

MERCH

TECH

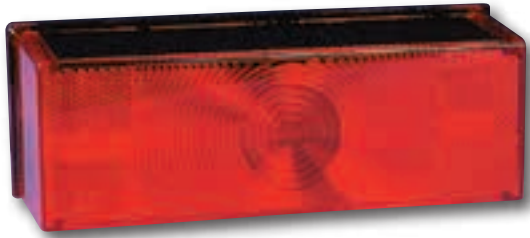

## 456 Over 80" Wide Submersible Combination Tail Light



- Low-profile, over 80" submersible combination tail light.
- Includes the following functions: stop, turn, tail, rear clearance, rear reflex, side marker, side reflex, and license light ("L" suffix).
- Housing slides out for easy maintenance and bulb replacement while maintaining gasket seal.
- Grounds through separate lead wire.
- "-3P" versions are terminated with an industry-standard PL3 plug.
- Mounts on slide-on 2" centers and includes mounting hardware.
- Available in manufacturer's pack or visual pack.

Order No.	Description	Pack	Std Carton
V456	curbside light	Viz Pack	6
V456L	roadside light	Viz Pack	6
M456	curbside light	mfg. pack	30
M456-3P	curbside light, PL3 plug	mfg. pack	30
M456L	roadside light	mfg. pack	30
M456L-3P	roadside light, PL3 plug	mfg. pack	30
1157	replacement bulb (stop & tail)	<i>reference only</i>	
194/193	replacement bulb (side)	<i>reference only</i>	

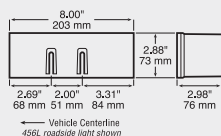

## 457 Combination Rear Light



- Combination tail light with polar white base.
- Attractive rounded shape.
- Rugged, corrosion-resistant bulb socket.
- Includes the following functions: stop, turn, tail, rear reflex, and license light ("L" suffix).
- M457L includes license illuminator and license plate mounting bracket.
- Grounds through mounting hardware.
- Designed for horizontal mounting.
- Popular for use on enclosed trailers or recreational vehicles.
- Available in manufacturer's pack or visual pack.

Order No.	Description	Pack	Std Carton
V457	without license light	Viz Pack	6
V457L	with license light	Viz Pack	6
M457	without license light	mfg. pack	48
M457L	with license light	mfg. pack	48
B457-15	replacement lens	poly pack	40
B457L-15	replacement lens	poly pack	40
1157	replacement bulb (stop & tail)	<i>reference only</i>	

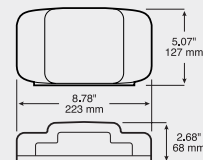



# INCANDESCENT COMBINATION REAR



## 25911 / 25912 / 25913 / 25914 RV Combination Rear Light with Reflex



- Surface mount rear combination tail light.
- Available with or without integral back-up light.
- Available with or without integral license light & plate mounting bracket.
- Popular for RV applications.
- Self-service Viz Pack packaging.

Order No.	Description	Pack	Std Carton
V25911	red	Viz Pack	10
V25912	red w/ back-up light	Viz Pack	10
V25913	red w/ license light and bracket	Viz Pack	10
V25914	red w/ license light, brkt, back-up	Viz Pack	10
V25911-25	replacement lens	Viz Pack	10
V25912-25	repl. lens w/ back-up light	Viz Pack	10
V25913-25	repl. lens w/ license light	Viz Pack	10
V25914-25	repl. lens w/ license & back-up	Viz Pack	10
1157	replacement S/T/T bulb	<i>reference only</i>	
1156	replacement backup bulb	<i>reference only</i>	

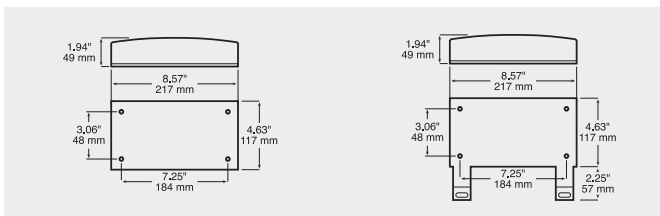

# STOP TURN & TAIL LIGHTS



## 25921 / 25922 / 25923 / 25924 RV Combination Rear Light with Reflex



- Surface mount rear combination tail light.
- Available with or without integral back-up light.
- Available with or without integral license light & plate mounting bracket.
- Popular for RV applications.
- Self-service Viz Pack packaging.

Order No.	Description	Pack	Std Carton
V25921	red	Viz Pack	10
V25922	red w/ back-up light	Viz Pack	10
V25923	red w/ license light and bracket	Viz Pack	10
V25924	red w/ license light, brkt, back-up	Viz Pack	10
V25921-25	replacement lens	Viz Pack	10
V25922-25	repl. lens w/ back-up light	Viz Pack	10
V25923-25	repl. lens w/ license light	Viz Pack	10
V25924-25	repl. lens w/ license & back-up	Viz Pack	10
1157	replacement S/T/T bulb	<i>reference only</i>	
1156	replacement backup bulb	<i>reference only</i>	

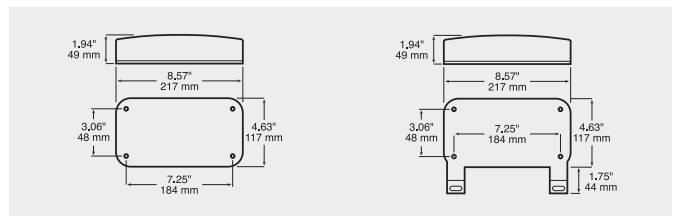

ST

TURN

MARKER

B-U/UTIL

SPEC

EMERG

ECE

MOUNT

ELECT

REFLECT

ACCY

MERCH

TECH



## 540 Under 80" Wide Trailer Light Kit



- Complete light kit for small trailers provides all legal lighting and reflectors for trailers under 80" wide.
- 540 kit include one each of 440/440L tail light, two 114A side marker lights, 20' trailer harness, license bracket, mounting hardware, and installation instructions.
- V440-15 lens kit contains two lenses: one 440-15 and one 55-15R.

Order No.	Description	Pack	Std Carton
V540	<b>KIT</b> w/ 20 ft. harness & side markers	Viz Pack	2
M540	<b>KIT</b> w/ 20 ft. harness & side markers	box	12
V440-15	lens kit	Viz Pack	12
440-15	stop & tail replacement lens	poly pack	10
55-15R	side marker replacement lens	poly pack	10
114-15A	amber replacement lens	poly pack	10
1157	replacement bulb (stop & tail)	reference only	
168	replacement bulb (rear marker)	reference only	
194/193	replacement bulb (front marker)	reference only	

## 541 Under 80" Wide Trailer Rear Light Kit



- Rear light kit provides legal rear lighting and reflectors for trailers under 80" wide.
- Includes one each of 440/440L tail light, 20' trailer harness, license bracket, mounting hardware, and installation instructions.
- V440-15 lens kit contains three lenses: 440-15, 55-15R & 55-15A.
- Front side marker/clearance lights and front side reflectors are necessary to meet all DOT requirements.

Order No.	Description	Pack	Std Carton
541	<b>KIT</b> 20 ft. harness	box	4
V440-15	lens kit	Viz Pack	12
440-15	stop & tail replacement lens	poly pack	10
55-15R	side marker replacement lens	poly pack	10
1157	replacement bulb (stop & tail)	reference only	
168	replacement bulb (rear marker)	reference only	



**544**  
Over 80" Wide Submersible Rear Light Kit



- Over 80" submersible rear lighting kit for all trailers.
- Kit provides rear lighting and reflectors for trailers over 80" wide.
- Includes one each of our 452/452L tail light, 25' trailer harness, license bracket, mounting hardware, and installation instructions.
- Front side marker/clearance lights, front side reflectors and rear identification lights are necessary to meet all DOT requirements.

Order No.	Description	Pack	Std Carton
V544	<b>KIT</b> kit	Viz Pack	2
440-15	stop & tail replacement lens	poly pack	10
56-15R	side marker replacement lens	poly pack	10
1157	replacement bulb (stop & tail)		<i>reference only</i>
194/193	replacement bulb (side marker)		<i>reference only</i>

**547**  
Over 80" Wide Submersible Rear Light Kit



- Over 80" submersible rear lighting kit for all trailers.
- Provides rear lighting and reflectors for trailers 80" wide and over.
- Includes one each of our low profile 456/456L tail light, 25' trailer harness, license bracket, mounting hardware, and installation instructions.
- Front side marker/clearance lights, side reflectors and rear identification lights are necessary to meet all DOT requirements.

Order No.	Description	Pack	Std Carton
V547	<b>KIT</b> kit	Viz Pack	2
1157	replacement bulb (stop & tail)		<i>reference only</i>
194/193	replacement bulb (side marker)		<i>reference only</i>

ST  
TURN  
MARKER  
B-U/UTIL  
SPEC  
EMERG  
ECE  
MOUNT  
ELECT  
REFLECT  
ACCY  
MERCH  
TECH

# TURN SIGNALS



## 817-7/818-7 LumenX® LED 4" Round Front & Rear Turn Signal



- Meets DOT standards for both **FRONT** and **REAR** turn signal use.
- White diodes and advanced optics fully illuminate amber lens.
- 817/818 series have both turn signal and low intensity marker light.
- 4731 lacks low light function.
- Meets DOT side marker requirements.
- AMP-compatible connector integrated into housing.
- 818-7 has flange integrated into the housing.
- 817-7 has skirted weld joint for added protection against moisture.
- 9–16 volt operating range.
- Regulated design provides voltage protection and consistent light output over a wide voltage range.
- Does not require “Top” positioning to meet FMVSS 108 standard.
- 817 kit includes light, grommet and 817-49 plug.
- 818 kit includes light and 817-49 plug.

Order No.	Description	Pack	Std Carton
817A-7	grommet mount	poly pack	6
818A-7	flange mount	poly pack	6
817KA-7	<b>KIT</b> grommet mount kit	poly pack	6
818KA-7	<b>KIT</b> flange mount kit	poly pack	6
M817A-7	grommet mount	mfg. pack	50
M818A-7	flange mount	mfg. pack	50
4731	grommet, w/o low-light function	mfg. pack	50
426-18	grommet	poly pack	12
B426-18	grommet	mfg. pack	100
417-49	hardshell plug	poly pack	6
B417-49	hardshell plug	mfg. pack	100
817-49	molded plug	poly pack	12
B817-49	molded plug	mfg. pack	100

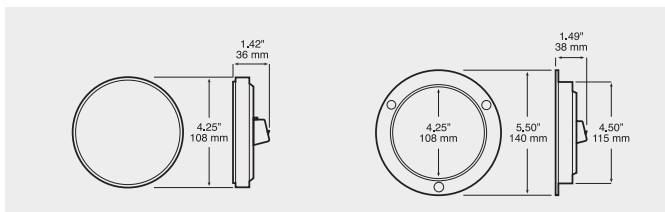

# LED TURN SIGNALS



## 824-7/826-7 LumenX® LED 4" Round Front & Rear Turn Signal



- Meets DOT standards for both **FRONT** and **REAR** turn signal use.
- White diodes and advanced optics fully illuminate amber lens.
- Includes both turn signal and low intensity marker light circuits.
- Meets DOT side marker requirements.
- Industry-standard PL3 socket integrated into housing.
- 824-7 has flange integrated into the housing.
- 826-7 has skirted weld joint for added protection against moisture.
- 9–16 volt operating range.
- Regulated design provides voltage protection and consistent light output over a wide voltage range.
- Does not require “Top” positioning to meet FMVSS 108 standard.
- 826 kit includes light, grommet and 431-491 plug.
- 824 kit includes light and 431-491 plug.

Order No.	Description	Pack	Std Carton
V826KA-7	<b>KIT</b> grommet mount kit	Viz Pack	6
V824KA-7	<b>KIT</b> flange mount kit	Viz Pack	6
826A-7	grommet mount	poly pack	6
824A-7	flange mount	poly pack	6
826KA-7	<b>KIT</b> grommet mount kit	poly pack	6
824KA-7	<b>KIT</b> flange mount kit	poly pack	6
M826A-7	grommet mount	mfg. pack	50
M824A-7	flange mount	mfg. pack	50
426-18	grommet	poly pack	12
B426-18	grommet	mfg. pack	100
431-491	plug	poly pack	12
B431-491	plug	mfg. pack	100

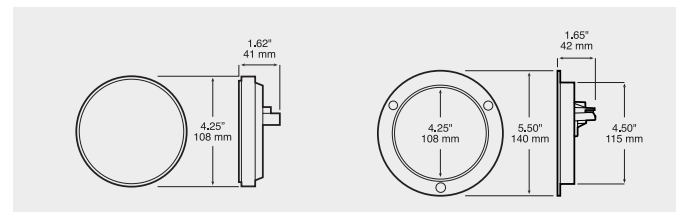

# LED TURN SIGNALS



## 817-9/818-9 LumenX® LED 4" Round Front & Rear Turn Signal



- Meets DOT standards for both **FRONT** and **REAR** turn signal use.
- White diodes and advanced optics fully illuminate amber lens.
- Includes both turn signal and low intensity marker light circuits.
- Meets DOT side marker requirements.
- AMP-compatible connector integrated into housing.
- Regulated design provides voltage protection and consistent light output over a wide voltage range.
- 818-9 has flange integrated into the housing.
- 817-9 has skirted weld joint for added protection against moisture.
- 9-32 volt operating range is compatible with 12V and 24V vehicles.
- Does not require "Top" positioning to meet FMVSS 108 standard.
- 817 kit includes light, grommet and 817-49 plug.
- 818 kit includes light and 817-49 plug.

Order No.	Description	Pack	Std Carton
817A-9	grommet mount	poly pack	6
818A-9	flange mount	poly pack	6
817KA-9	<b>KIT</b> grommet mount kit	poly pack	6
818KA-9	<b>KIT</b> flange mount kit	poly pack	6
M817A-9	grommet mount	mfg. pack	50
M818A-9	flange mount	mfg. pack	50
426-18	grommet	poly pack	12
B426-18	grommet	mfg. pack	100
417-49	hardshell plug	poly pack	6
B417-49	hardshell plug	mfg. pack	100
817-49	molded plug	poly pack	12
B817-49	molded plug	mfg. pack	100

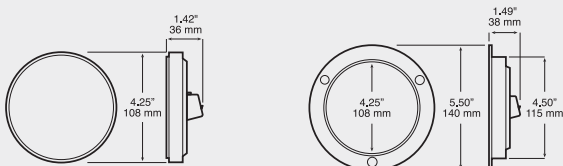

# TURN SIGNALS



## 824-9/826-9 LumenX® LED 4" Round Front & Rear Turn Signal



- Meets DOT standards for both **FRONT** and **REAR** turn signal use.
- White diodes and advanced optics fully illuminate amber lens.
- Includes both turn signal and low intensity marker light circuits.
- Meets DOT side marker requirements.
- Industry-standard PL3 socket integrated into housing.
- Regulated design provides voltage protection and consistent light output over a wide voltage range.
- 824-9 has flange integrated into the housing.
- 826-9 has skirted weld joint for added protection against moisture.
- 9-32 volt operating range is compatible with 12V and 24V vehicles.
- Does not require "Top" positioning to meet FMVSS 108 standard.
- 826 kit includes light, grommet and 431-491 plug.
- 824 kit includes light and 431-491 plug.

Order No.	Description	Pack	Std Carton
826A-9	grommet mount	poly pack	6
824A-9	flange mount	poly pack	6
826KA-9	<b>KIT</b> grommet mount kit	poly pack	6
824KA-9	<b>KIT</b> flange mount kit	poly pack	6
M826A-9	grommet mount	mfg. pack	50
M824A-9	flange mount	mfg. pack	50
426-18	grommet	poly pack	12
B426-18	grommet	mfg. pack	100
431-491	plug	poly pack	12
B431-491	plug	mfg. pack	100

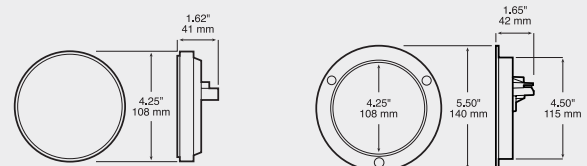

STT  
TURN  
MARKER  
B-U/UTIL  
SPEC  
EMERG  
ECE  
MOUNT  
ELECT  
REFLECT  
ACCY  
MERCH  
TECH



## 820-7/823-7 LumenX® LED Oval Front & Rear Turn Signal



- Meets DOT standards for both **FRONT** and **REAR** turn signal use.
- White diodes behind amber lens.
- Advanced optics fully illuminate lens.
- AMP-compatible connector integrated into housing.
- 823-7 has flange welded to light, forming a single unit.
- 820 kit includes light, grommet and 817-49 plug.
- 823 kit includes light and 817-49 plug.
- 9–16 volt operating range.
- Includes both turn signal and low intensity marker light circuits.
- Meets DOT side marker requirements.
- Regulated design provides voltage protection and consistent light output over a wide voltage range.
- Meets FMVSS 108 requirements in horizontal, vertical or any 360° position.

Order No.	Description	Pack	Std Carton
820A-7	grommet mount	poly pack	6
823A-7	flange mount	poly pack	6
820KA-7	<b>KIT</b> grommet mount kit	poly pack	6
823KA-7	<b>KIT</b> flange mount kit	poly pack	6
M820A-7	grommet mount	mfg. pack	50
M823A-7	flange mount	mfg. pack	50
421-18	grommet	poly pack	12
B421-18	grommet	mfg. pack	100
417-49	hardshell plug	poly pack	6
B417-49	hardshell plug	mfg. pack	100
817-49	molded plug	poly pack	12
B817-49	molded plug	mfg. pack	100

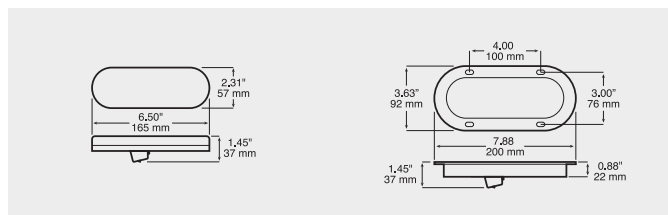

## 821-7/822-7 LumenX® LED Oval Front & Rear Turn Signal



- Meets DOT standards for both **FRONT** and **REAR** turn signal use.
- White diodes behind amber lens.
- Advanced optics fully illuminate lens.
- Includes both turn signal and low intensity marker light circuits.
- Meets DOT side marker requirements.
- Industry-standard PL3 socket integrated into housing.
- 822-7 has flange welded to light, forming a single unit.
- 9–16 volt operating range.
- Regulated design provides voltage protection and consistent light output over a wide voltage range.
- Meets FMVSS 108 requirements in horizontal, vertical or any 360° position.
- 821 kit includes light, grommet and 421-491 plug.
- 822 kit includes light and 421-491 plug.

Order No.	Description	Pack	Std Carton
V821KA-7	<b>KIT</b> grommet mount kit	Viz Pack	6
V822KA-7	<b>KIT</b> flange mount kit	Viz Pack	6
821A-7	grommet mount	poly pack	6
822A-7	flange mount	poly pack	6
821KA-7	<b>KIT</b> grommet mount kit	poly pack	6
822KA-7	<b>KIT</b> flange mount kit	poly pack	6
M821A-7	grommet mount	mfg. pack	50
M822A-7	flange mount	mfg. pack	50
421-18	grommet	poly pack	12
B421-18	grommet	mfg. pack	100
421-491	plug	poly pack	12
B421-491	plug	mfg. pack	100

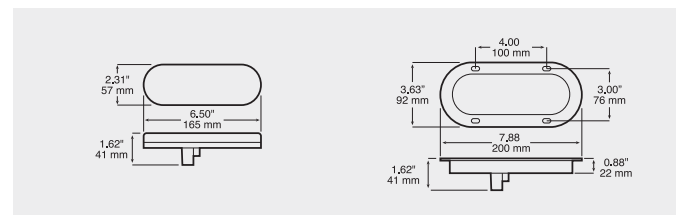

# LED TURN SIGNALS



## 820-10/823-10 LumenX® LED Oval Front & Rear Turn Signal



- Meets DOT standards for both **FRONT** and **REAR** turn signal use.
- White diodes behind amber lens.
- Advanced optics fully illuminate lens.
- Includes both turn signal and low intensity marker light circuits.
- Meets DOT side marker requirements.
- AMP-compatible connector integrated into housing.
- Regulated design provides voltage protection and consistent light output over a wide voltage range.
- 823-10 has flange welded to light, forming a single unit.
- 9-32 volt operating range compatible with both 12V and 24V vehicles.
- Meets FMVSS 108 req. in horizontal, vertical or any 360° position.
- 820 kit includes light, grommet and 817-49 plug.
- 823 kit includes light and 817-49 plug.

Order No.	Description	Pack	Std Carton
820A-10	grommet mount	poly pack	6
823A-10	flange mount	poly pack	6
820KA-10	<b>KIT</b> grommet mount kit	poly pack	6
823KA-10	<b>KIT</b> flange mount kit	poly pack	6
M820A-10	grommet mount	mfg. pack	50
M823A-10	flange mount	mfg. pack	50
M823ATL-10	narrow, 2-screw flange	mfg. pack	50
421-18	grommet	poly pack	12
B421-18	grommet	mfg. pack	100
417-49	hardshell plug	poly pack	6
B417-49	hardshell plug	mfg. pack	100
817-49	molded plug	poly pack	12
B817-49	molded plug	mfg. pack	100

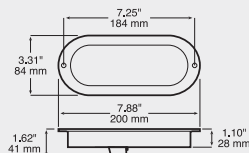
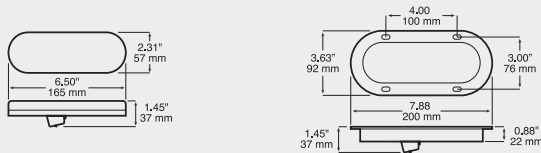

823ATL-10

# TURN SIGNALS



## 821-10/822-10 LumenX® LED Oval Front & Rear Turn Signal



- White diodes behind red lens.
- Advanced optics fully illuminate lens.
- Industry-standard PL3 socket integrated into housing.
- Regulated design provides voltage protection and consistent light output over a wide voltage range.
- 822-10 has flange welded to light, forming a single unit.
- 9-32 volt operating range is compatible with 12V and 24V vehicles.
- Meets FMVSS 108 requirements in horizontal, vertical or any 360° position.
- 821 kit includes light, grommet and 421-491 plug.
- 822 kit includes light and 421-491 plug.

Order No.	Description	Pack	Std Carton
821A-10	grommet mount	poly pack	6
822A-10	flange mount	poly pack	6
821KA-10	<b>KIT</b> grommet mount kit	poly pack	6
822KA-10	<b>KIT</b> flange mount kit	poly pack	6
M821A-10	grommet mount	mfg. pack	50
M822A-10	flange mount	mfg. pack	50
421-18	grommet	poly pack	12
B421-18	grommet	mfg. pack	100
421-491	plug	poly pack	12
B421-491	plug	mfg. pack	100

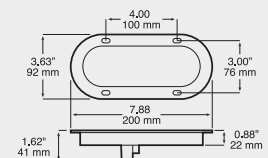
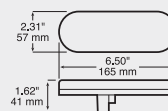

# TURN SIGNALS

# LED TURN SIGNALS



**TRADITIONAL 36 DIODE PIRANHA®**



**TRADITIONAL 36 DIODE PIRANHA®**



## 417TA/418TA Piranha® LED 4" Round Amber Rear Turn Signal Light



- 418TA has flange welded to light, forming a single unit.
- Does not require "Top" positioning to meet FMVSS 108.
- Hardwired leads are terminated with built-in 3-wire PL3 adapter.
- See matching stop/turn/tail light on page 8.
- For grommet-mount Viz Pack version with PL3 plug, see V417KTA at right.

Order No.	Description	Pack	Std Carton
V418KTA	amber w/ flange & adapter plug	Viz Pack	6
M417TA-P	amber w/ adapter plug	mfg. pack	50
M418TA-P	amber w/ flange & adapter plug	mfg. pack	50
426-18	grommet	poly pack	12
B426-18	grommet	mfg. pack	100

## 417KTA/817-36/818-36 Piranha® LED 4" Round Amber Rear Turn Signal Light



- Original 36-diode Piranha multi-diode lens look.
- AMP-compatible connector integrated into housing.
- Advanced white diodes behind red lens.
- 818-36 has flange welded to light, forming a single unit.
- 817-36 has skirted weld joint for added protection against moisture.
- 9–16 volt operating range.
- Regulated design provides voltage protection and consistent light output over a wide voltage range.
- Does not require "Top" positioning to meet FMVSS 108 standard.
- V417KTA Viz-Pack kit includes light, grommet and 417-491 adapter plug.
- See page 8 for matching red stop/turn/tail light.



417-491

Order No.	Description	Pack	Std Carton
V417KTA	<b>KIT</b> red w/ grommet & adapter plug	Viz Pack	6
817A-36	red, grommet mount	poly pack	6
818A-36	red, flange mount	poly pack	6
M817A-36	red, grommet mount	mfg. pack	50
M818A-36	red, flange mount	mfg. pack	50
426-18	grommet	poly pack	12
B426-18	grommet	mfg. pack	100
417-49	hardshell plug	poly pack	6
B417-49	hardshell plug	mfg. pack	100
817-49	molded plug	poly pack	12
B817-49	molded plug	mfg. pack	100

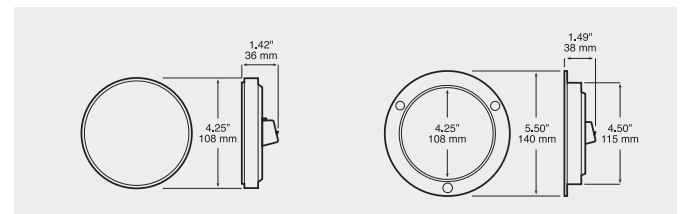
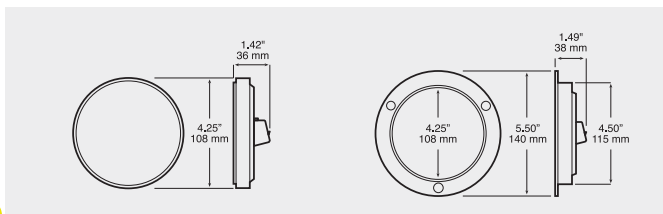



# LED TURN SIGNALS



**TRADITIONAL 22 DIODE  
PIRANHA®**



## 821-22/822-22 Piranha® LED Oval Amber Rear Turn Signal Light



- Original 22-diode Piranha multi-diode lens look.
- PL3-compatible connector integrated into housing.
- Advanced white diodes behind amber lens.
- 822-22 has flange welded to light, forming a single unit.
- 821KA Viz Pack kit includes light, grommet, and 421-491 plug.
- 9–16 volt operating range.
- Regulated design provides voltage protection and consistent light output over a wide voltage range.
- Meets FMVSS 108 req. in horizontal, vertical or any 360° position.
- See page 9 for matching red stop/turn/tail light.

Order No.	Description	Pack	Std Carton
V821A-22	amber	Viz Pack	6
V821KA-22	<b>KIT</b> amber kit w/ grommet & plug	Viz Pack	6
821A-22	amber, grommet mount	poly pack	6
822A-22	amber, flange mount	poly pack	6
M821A-22	amber, grommet mount	mfg. pack	50
M822A-22	amber, flange mount	mfg. pack	50
421-18	grommet	poly pack	12
B421-18	grommet	mfg. pack	100
421-491	plug	poly pack	12
B421-491	plug	mfg. pack	100

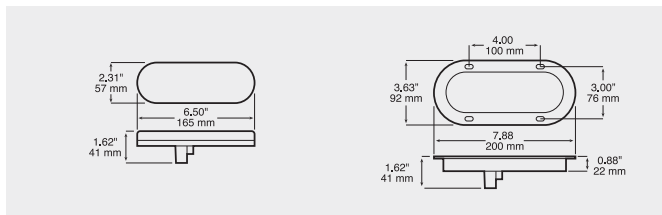

# TURN SIGNALS



**TRADITIONAL 22 DIODE  
PIRANHA®**



## 820-22/823-22 Piranha® LED Oval Amber Rear Turn Signal Light



- Original 22-diode Piranha multi-diode lens look.
- AMP-compatible connector integrated into housing.
- Advanced white diodes behind amber lens.
- 823-22 has flange welded to light, forming a single unit.
- 9–16 volt operating range.
- Regulated design provides voltage protection and consistent light output over a wide voltage range.
- Meets FMVSS 108 req. in horizontal, vertical or any 360° position.
- See page 9 for matching red stop/turn/tail light.

Order No.	Description	Pack	Std Carton
820A-22	amber, grommet mount	poly pack	6
823A-22	amber, flange mount	poly pack	6
M820A-22	amber, grommet mount	mfg. pack	50
M823A-22	amber, flange mount	mfg. pack	50
421-18	grommet	poly pack	12
B421-18	grommet	mfg. pack	100
417-49	hardshell plug	poly pack	6
B417-49	hardshell plug	mfg. pack	100
817-49	molded plug	poly pack	12
B817-49	molded plug	mfg. pack	100

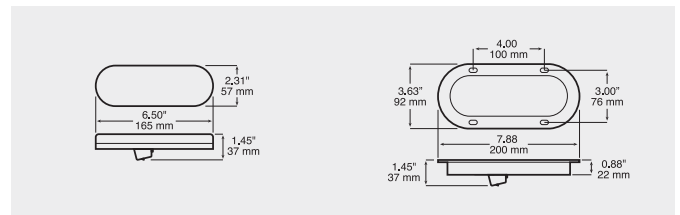

STT

TURN

MARKER

B-U/UTIL

SPEC

EMERG

ECE

MOUNT

ELECT

REFLECT

ACCY

MERCH

TECH

# TURN SIGNALS



# LED TURN SIGNALS



**RECESSED LENS**



## 817TA-2C/818TA-2C LED 4" Round Amber Rear Turn Signal Light



- Features amber diodes behind clear lens.
- AMP-compatible connector integrated into housing.
- 9-32 volt operating range is compatible with 12V and 24V vehicles.
- 818TA-2C has flange welded to light, forming a single unit.
- Does not require "Top" positioning to meet FMVSS 108 standards.
- Compatible with connecting plugs shown on pages 204–207.
- New design 817CA-9 & 818CA-9 coming soon.

Order No.	Description	Pack	Std Carton
817TA-2C	10 diodes w/ clear lens	poly pack	6
818TA-2C	10 diodes w/ clear lens, flange	poly pack	6
M817TA-2C	10 diodes w/ clear lens	mfg. pack	50
M818TA-2C	10 diodes w/ clear lens, flange	mfg. pack	50
426-18	grommet	poly pack	12
B426-18	grommet	mfg. pack	100
417-49	hardshell plug	poly pack	6
B417-49	hardshell plug	mfg. pack	100
817-49	molded plug	poly pack	12
B817-49	molded plug	mfg. pack	100

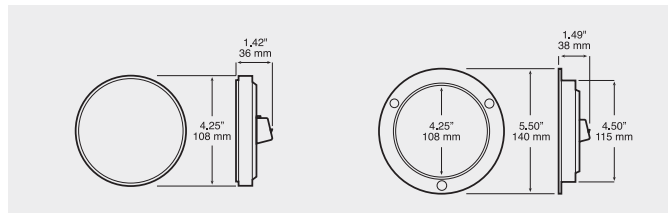

## 824/826 Single Diode LED 4" Round Amber Rear Turn Signal Light



- Single diode LED light with traditional incandescent lens look.
- Industry-standard PL3 socket integrated into housing with locking tabs for added plug retention.
- 9-32 operating range.
- Does not require "Top" positioning to meet FMVSS 108 standard.
- 826A requires 426-18 grommet.
- 824A features gray housing with integral mounting flange.
- 824A flange has recessed lens.
- 431-491 plug required for installation.

Order No.	Description	Pack	Std Carton
826A-MV	grommet mount, multi-volt	poly pack	6
824A-MV	flange mount, multi-volt	poly pack	6
M826A-MV	grommet mount, multi-volt	mfg. pack	50
M824A-MV	flange mount, multi-volt	mfg. pack	50
426-18	grommet	poly pack	12
B426-18	grommet	mfg. pack	100
431-491	plug	poly pack	12
B431-491	plug	mfg. pack	100

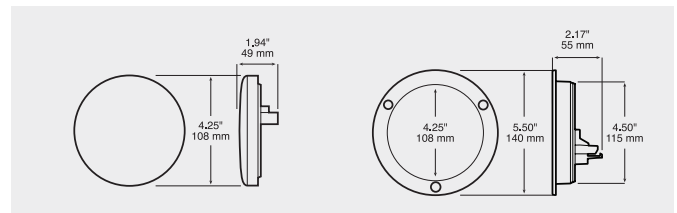

# LED TURN SIGNALS



## 418WTA LED Mid-Trailer, Wide-Turn Signal



- Designed to improve visibility on tractor/trailer applications.
- Features 4" amber turn signal mounted in L-bracket with bright "Caution Wide Turn" graphics.
- Commonly used in mid-turn applications.
- Can be configured for either right- or left-side application.
- Kit includes sign, light, and instruction sheet.
- Choice of 36-diode Piranha® or 7-diode LumenX® light.
- 418WTA includes 417-49 hardshell plug.
- 818WTA requires AMP-compatible plug to complete installation.

Order No.	Description	Pack	Std Carton
418WTA	<b>KIT</b> 36-diode Piranha®	box	6
818WTA	<b>KIT</b> 7-diode LumenX®	box	6
417-49	hardshell plug	poly pack	6
B417-49	hardshell plug	mfg. pack	100
817-49	molded plug	poly pack	12
B817-49	molded plug	mfg. pack	100

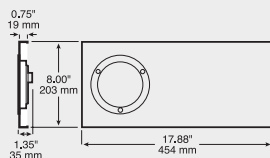

# TURN SIGNALS



## 817Y/818Y LED Bulls-Eye Sequential Auxiliary / Marker Light



- For use as auxiliary turn signal or warning/flasher. Not certified to meet FMVSS 108 rear turn requirements.
- Cycles through sequential flash pattern without external flasher unit.
- Includes low light function.
- Over-voltage and reverse voltage protection.
- AMP-compatible connector integrated into housing.
- Requires AMP-compatible plug to complete installation.
- Operates from 9-16 volts.
- Lens and housing welded to create watertight seal.
- 818 series has flange welded to housing to form a single unit.

Order No.	Description	Pack	Std Carton
817YA	grommet mount	poly pack	6
818YA	flange mount	poly pack	6
426-18	grommet	poly pack	12
B426-18	grommet	mfg. pack	100
417-49	hardshell plug	poly pack	6
B417-49	hardshell plug	mfg. pack	100
817-49	molded plug	poly pack	12
B817-49	molded plug	mfg. pack	100

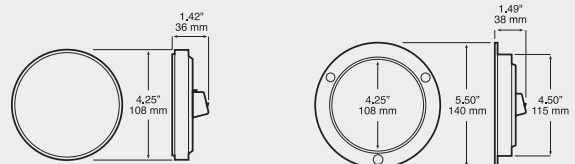

STT

TURN

MARKER

B-U/UTIL

SPEC

EMERG

ECE

MOUNT

ELECT

REFLECT

ACCY

MERCH

TECH

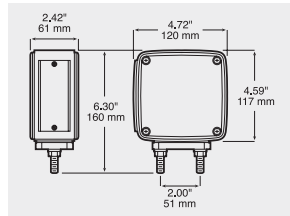

## 327 LED

### Double-Face Park & Turn Light w/ Side Marker



- Available with two amber lenses or with amber lens facing front of vehicle and red lens facing to rear.
- 327L for roadside use, 327R for curbside.
- Includes side marker function and reflex.
- 2-stud pedestal mount.
- 3-wire electrical connection.
- Two 4.5" square acrylic lenses.
- Chrome plated plastic housing.

Order No.	Description	Pack	Std Carton
V327AA	amber/amber	Viz Pack	6
V327L	amber/red, roadside	Viz Pack	6
V327R	amber/red, curbside	Viz Pack	6

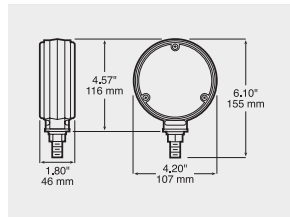

## 338-2 LED

### Double-Face Round Park & Turn Light



- Has amber lens facing front of vehicle, red lens facing to rear.
- Reversible for use on either side of vehicle.
- Single stud pedestal mount.
- 3-wire electrical connection.
- Two 4" round acrylic lenses.
- Chrome die-cast housing.

Order No.	Description	Pack	Std Carton
V338-2	amber/red	Viz Pack	6

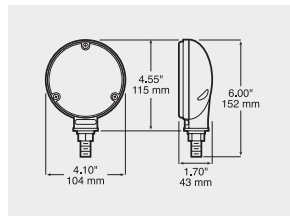

## 339 LED

### Single-Face Round Park & Turn or S/T/T Light



- 339A amber (front-facing) and 339R red (rear-facing) versions.
- Single stud pedestal mount.
- 3-wire electrical connection.
- Single 4" round acrylic lens.
- Chrome die-cast housing.
- V339R shown here is also listed with stop/turn/tail lights on page 17.

Order No.	Description	Pack	Std Carton
V339A	amber	Viz Pack	6
V339R	red	Viz Pack	6
339A-BT2	amber	mfg. pack	24

# LED TURN SIGNALS



## 319AA LED Double-Sided Agricultural Park/Turn/Warning Light



- ASAE S279.17 compliant.
- Perfect for all agricultural applications.
- Double-sided amber light.
- Works with all 12-volt vehicles.
- Can be mounted to vertical or horizontal surfaces.
- Stripped leads for easy installation.
- See matching stop/turn/tail light and combination light on page 17.

Order No.	Description	Pack	Std Carton
319AA	amber, stripped leads	mfg. pack	24

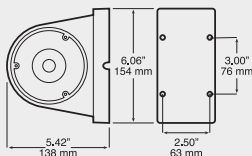

# TURN SIGNALS



Shown with grommet & plug, sold separately



## 320A/321A LumenX® LED Agricultural Turn/Marker/Warning Light



- Provides a minimum of 4 CP illumination at 90 degrees to lens face in every direction, regardless of installation orientation.
- Meets agricultural standard ASAE S279.17.
- Meets NHTSA's agricultural lamp requirement - U.S. Title 49 Part 562.
- Also meets FMVSS 108 standards for FRONT and REAR turn signal, parking lamp, clearance, and side marker.
- Fits standard oval mounting grommet.
- Includes both high intensity ag warning/turn, and low intensity park/marker light circuits.
- Three advanced white diodes behind precision-designed fresnel lens.
- PL3 or AMP compatible connector integrated into housing.
- 9-16 volt operating range w/ voltage regulation and over-voltage protection.
- Meets all applicable requirements in horizontal, vertical or any 360° position.

Order No.	Description	Pack	Std Carton
M320A	amber, AMP receptacle	mfg. pack	50
M321A	amber, PL3 receptacle	mfg. pack	50
B421-18	grommet	mfg. pack	100
B817-49	molded AMP-compatible plug	mfg. pack	100
B421-491	PL3 plug	mfg. pack	100

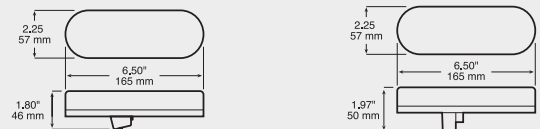

STT

TURN

MARKER

B-U/UTIL

SPEC

EMERG

ECE

MOUNT

ELECT

REFLECT

ACCY

MERCH

TECH

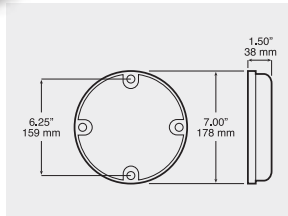

## 717 LED 7" Transit Front & Rear Turn Signal



- Round, 7-inch size popular for bus and transit applications.
- Sealed potted design.
- 9–32 volt operating range.
- Surface mount with standard 4-hole mounting pattern.
- Comes standard with mounting gasket providing additional protection between lamp and mounting surface.
- Hardwired leads terminated with .180 male bullet and ring terminal for ground.
- Matching red stop/turn/tail light available on page 16.
- Matching white back-up light available on page 99.

Order No.	Description	Pack	Std Carton
717A	surface mount	poly pack	20

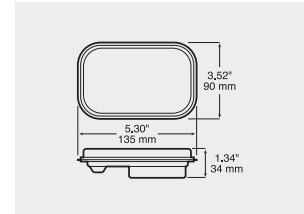

## 850-1 LED Rectangular Rear Turn Signal



- Certified to meet both FMVSS 108 (USA) & ECE (European) requirements for rear turn signal in horizontal or vertical position.
- Sealed lens and housing meets IP67 ingress protection level.
- 9–32 volt operating range.
- Hardwired design eliminates the need for separate plug and reduces connection points.
- 850A has 6.5' leads, others have 300mm (11.8") leads.
- 850A-1P has hardwired PL3 plug. Others have stripped leads.
- Matching red stop/turn/tail light on page 16.
- Matching white back-up light on page 99.

Order No.	Description	Pack	Std Carton
P850A-1	amber, 12" leads	poly pack	6
850A	amber, 6.5' sheathed leads	mfg. pack	10
850A-1	amber, 12" leads	mfg. pack	10
850A-1P	amber, 12" leads w/ PL3 plug	mfg. pack	10
850-18	grommet	poly pack	12
B850-18	grommet	mfg. pack	50



Shown with accessory bezel installed

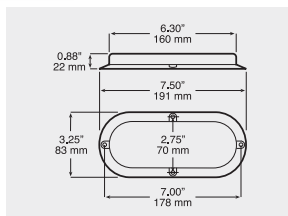

## 423A-4 LED Surface Mount Oval Auxiliary Turn Signal



- 9–32 volt operating range.
- Surface mounting for quick and versatile installation.
- Decorative snap-on chrome bezel available as accessory.
- Matching stop/turn/tail version available. See page 15.

Order No.	Description	Pack	Std Carton
423A-4	amber	poly pack	6
M423A-4	amber	mfg. pack	50
423-11	accessory chrome bezel	poly pack	12
B423-11	accessory chrome bezel	mfg. pack	50



## 420Q/423Q LED Amber Sequential Auxiliary / Marker Light



- Sealed, oval 35 LED sequential-arrow light for auxiliary applications such as mid-turn signal or warning light.
- Cycles through multiple sequential arrows until fully illuminated.
- Hardwired design includes 3-wire molded adapter plug.
- 9-32 volt operating range.
- Over-voltage and reverse voltage protection.
- Available in grommet or flange mount models.
- Low light function meets DOT side marker light requirement.

Order No.	Description	Pack	Std Carton
420QA-P	amber	poly pack	6
423QA-P	amber w/ flange	poly pack	6
421-18	grommet	poly pack	12
B421-18	grommet	mfg. pack	100

## 820Q/823Q LED Amber Sequential Auxiliary / Marker Light



- Sealed, oval 35 LED sequential-arrow light for auxiliary applications such as mid-turn signal or warning light.
- Cycles through multiple sequential arrows until fully illuminated.
- AMP-compatible connector integrated into housing.
- 9-32 volt operating range.
- Over-voltage and reverse voltage protection.
- Available in grommet or flange mount models.
- Low light function meets DOT side marker light requirement.
- 820QA requires grommet for installation.
- Plug required to complete installation.

Order No.	Description	Pack	Std Carton
820QA	amber	poly pack	6
823QA	amber w/ flange	poly pack	6
823QCA	amber, clear lens w/ flange	poly pack	6
421-18	grommet	poly pack	12
B421-18	grommet	mfg. pack	100
417-49	hardshell plug	poly pack	6
B417-49	hardshell plug	mfg. pack	100
817-49	molded plug	poly pack	12
B817-49	molded plug	mfg. pack	100

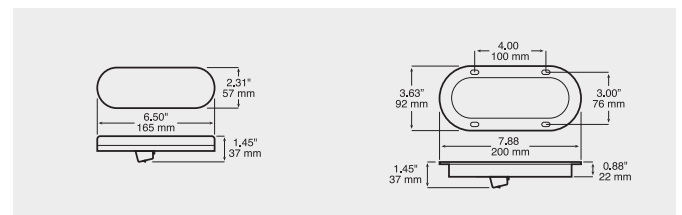
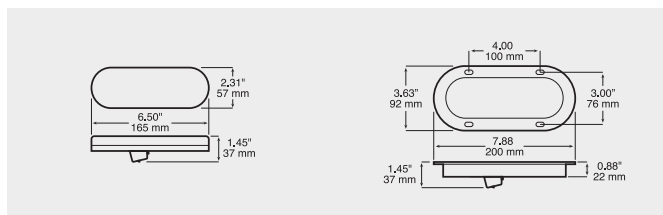

STT  
TURN  
MARKER  
B-U/UTIL  
SPEC  
EMERG  
ECE  
MOUNT  
ELECT  
REFLECT  
ACCY  
MERCH  
TECH

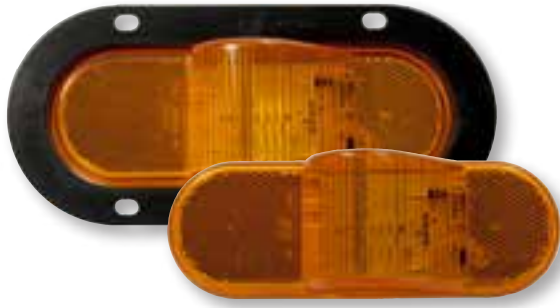

## 350 LED Oval Amber Auxiliary/Mid-Turn Light w/ Reflex



- Two-function, 6-diode LED light that may be used as auxiliary mid-turn, while providing intermediate side marker light and side reflector.
- Hardwired design eliminates plug, reduces connection points.
- Features sealed lens and housing.
- Operates from 9-32 volts.
- Equipped with hardwired AMP hardshell connector; "-P" version terminated with standard PL3 plug.
- 350A-PKD2 has only two leads, features high intensity turn function only (no side marker function).

Order No.	Description	Pack	Std Carton
350A-P	amber w/ plug	poly pack	6
350AF	amber w/ flange	poly pack	6
M350A	amber	mfg. pack	50
M350AF	amber w/ flange	mfg. pack	50
M350A-P	amber w/ plug	mfg. pack	50
M350A-PKD2	amber, high intensity light only	mfg. pack	4
421-18	grommet	poly pack	12
B421-18	grommet	mfg. pack	100

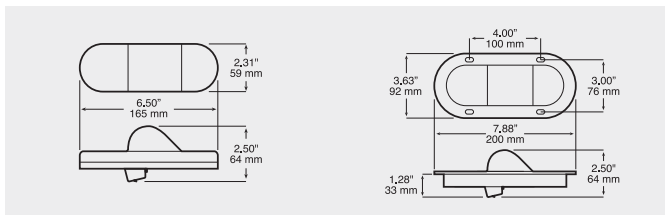

## 351 LumenX® LED Oval Amber Auxiliary/Mid-Turn Light w/ Reflex



- Two-function, 6-diode LED light that may be used as auxiliary mid-turn, while providing intermediate side marker light and side reflector.
- Integrated industry-standard PL3 socket.
- Sealed lens and housing.
- Operates from 9-16 volts.
- Compatible with connecting plugs shown on pages 207–209.

Order No.	Description	Pack	Std Carton
V351A	amber	Viz Pack	6
351A	amber	poly pack	6
351AF	amber w/ flange	poly pack	6
M351A	amber	mfg. pack	50
M351AF	amber w/ flange	mfg. pack	50
421-18	grommet	poly pack	12
B421-18	grommet	mfg. pack	100
421-491	plug	poly pack	12
B421-491	plug	mfg. pack	100

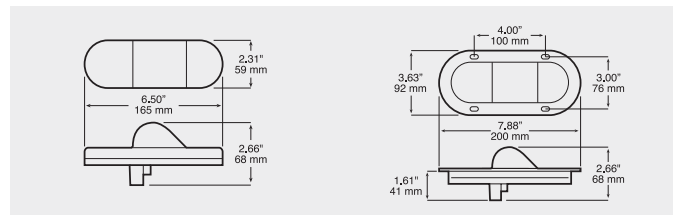



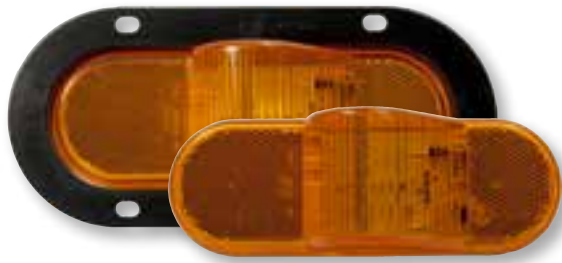

## 355 LumenX® LED Oval Amber Auxiliary/Mid-Turn Light w/ Reflex



- Two-function, 6-diode LED light that may be used as auxiliary mid-turn light, while functioning as side marker light and side reflector.
- AMP-compatible connector integrated into housing.
- Sealed lens and housing.
- Operates from 9-16 volts.
- Compatible with connecting plugs shown on pages 204–207.

Order No.	Description	Pack	Std Carton
355A	amber	poly pack	6
M355A	amber	mfg. pack	50
M355AF	amber w/ flange	mfg. pack	50
421-18	grommet	poly pack	12
B421-18	grommet	mfg. pack	100
417-49	hardshell plug	poly pack	6
B417-49	hardshell plug	mfg. pack	100
817-49	molded plug	poly pack	12
B817-49	molded plug	mfg. pack	100

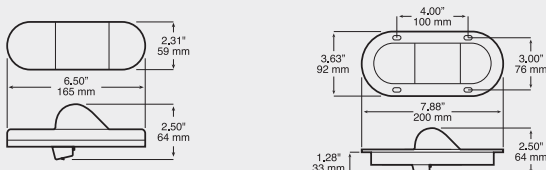

**CALIFORNIA  
COMPLIANT**



## 356 LumenX® LED Oval Amber Auxiliary/Mid-Turn Light w/ Reflex



- Two-function light may be used as mid-turn, while providing intermediate side marker light and side reflector.
- AMP-compatible connector integrated into housing.
- Meets SAE J914B, SAE J2039 specifications.
- Meets CA Title 13 requirements.
- 9-16 volt operating range.
- Regulated design provides voltage protection and consistent output.
- Available in grommet and flange mount versions.
- Compatible with connecting plugs shown on pages 204–207.

Order No.	Description	Pack	Std Carton
356A	amber	poly pack	6
356AF	amber w/flange	poly pack	6
M356A	amber	mfg. pack	50
M356AF	amber w/flange	mfg. pack	50
421-18	grommet	poly pack	12
B421-18	grommet	mfg. pack	100
417-49	hardshell plug	poly pack	6
B417-49	hardshell plug	mfg. pack	100
817-49	molded plug	poly pack	12
B817-49	molded plug	mfg. pack	100

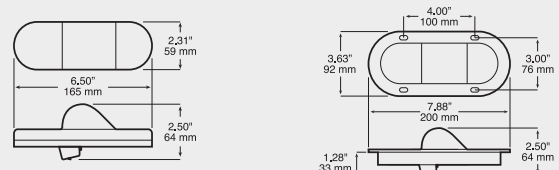

STT

TURN

MARKER

B-U/UTIL

SPEC

EMERG

ECE

MOUNT

ELECT

REFLECT

ACCY

MERCH

TECH



### 426 Sealed 4" Round Amber Turn Signal



- Meets DOT requirements for rear turn signal and/or front park & turn.
- Kits include light, grommet and 431-491 straight plug.
- See 426R stop and tail, and 415 back-up light for companion models.
- 12-volt lamps have long life, dual-filament, 2.1/59 amp, 32/3 cp bulb.
- See 826A-MV LED version on page 40.

Order No.	Description	Pack	Std Carton
426A	amber	poly pack	12
426KA	<b>KIT</b> amber kit	poly pack	12
M426A	amber	mfg. pack	48
426-18	grommet	poly pack	12
B426-18	grommet	mfg. pack	100
431-491	3-wire plug	poly pack	12
B431-491	3-wire plug	mfg. pack	100

### 431A Sealed 4" Round Amber Turn Signal



- Meets DOT requirements for rear turn signal and/or front park & turn
- Features extra wide, spin-welded, tongue-and-groove lens lip.
- High performance, copper alloy conductors.
- Heavy duty bulb and socket prevents premature bulb failure.
- Kit includes light, grommet, and plug.
- See 826A-MV LED version on page 40.

Order No.	Description	Pack	Std Carton
M431KA	<b>KIT</b> amber kit	mfg. pack	50
426-18	grommet	poly pack	12
B426-18	grommet	mfg. pack	100
431-49	2-wire plug	poly pack	12
B431-49	2-wire plug	mfg. pack	100
431-491	3-wire plug	poly pack	12
B431-491	3-wire plug	mfg. pack	100

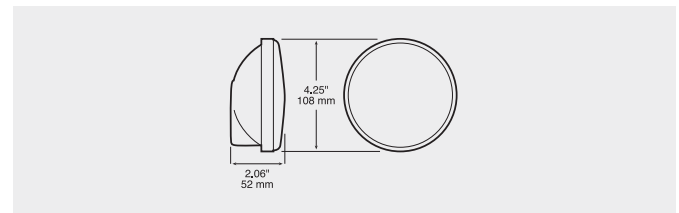
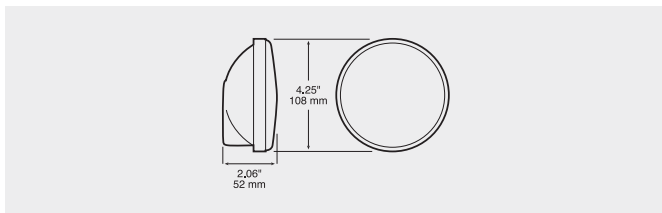

# INCANDESCENT TURN SIGNALS



421-491

## 421 Sealed Oval Amber Turn Signal



- Meets DOT requirements for rear turn signal and/or front park & turn signal in either horizontal or vertical position.
- Kits include light, grommet, and right-angle plug.
- See 421R stop and tail, and 416 back-up light for companion models.
- Equipped with dual-filament, 2.1/59 amp, 32/3 cp bulb.
- See LED versions on page 36–37.

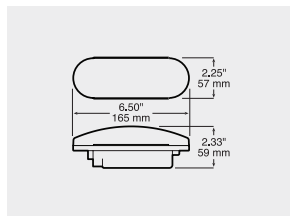

Order No.	Description	Pack	Std Carton
421A	amber	poly pack	12
421KA	<b>KIT</b> amber kit	poly pack	12
M421A	amber	mfg. pack	48
M421KA	<b>KIT</b> amber kit	mfg. pack	48
421-18	grommet	poly pack	12
B421-18	grommet	mfg. pack	100
421-491	3-wire plug	poly pack	12
B421-491	3-wire plug	mfg. pack	100

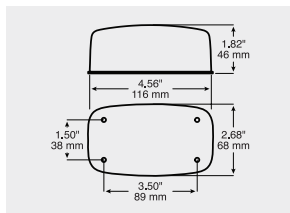
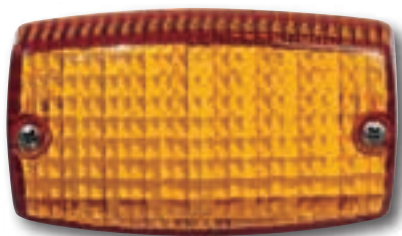

# TURN SIGNALS



## 450A Sealed Rectangular Amber Turn Signal



- Sealed, 3" x 5" amber parking & turn signal light.
- Popular on commercial market vehicles; fits competitive rectangular lights.
- Kit includes light, grommet, and plug.
- Can be matched with 450R red S/T/T light on page 26.
- See 850A-1 LED version on page 44.

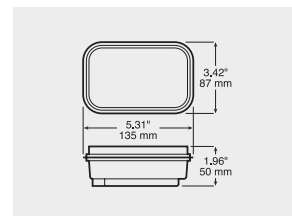

Order No.	Description	Pack	Std Carton
450KA	<b>KIT</b> amber kit	poly pack	20
450-18	grommet	poly pack	12
B450-18	grommet	mfg. pack	100
421-491	3-wire plug	poly pack	12
B421-491	3-wire plug	mfg. pack	100

## 306 Surface-Mount Rectangular Turn Signal Light



- 306A functions as turn signal and parking light.
- Features polycarbonate lens, durable galvanized steel base plate, and tough nylon bushing to protect lead wires.
- Grounds through mounting screw.
- Less than 75 sq. cm of effective, projected luminous lens area. For use on vehicles under 80" wide.
- See matching 306R stop/turn/tail light on page 21.
- See matching 393C back-up light on page 100.

Order No.	Description	Pack	Std Carton
V306A	amber	Viz Pack	6
306A	amber	poly pack	24
306-25A	amber lens	poly pack	10
2057	replacement bulb		<i>reference only</i>

STT  
TURN  
MARKER  
B-U/UTIL  
SPEC  
EMERG  
ECE  
MOUNT  
ELECT  
REFLECT  
ACCY  
MERCH  
TECH

# TURN SIGNALS



## 343 Combination Side Turn Signal & Side Marker



- Surface-mount unit meets SAE recommended practice for side turn signal, while providing marker light functions.
- Popular model commonly referred to as a mid-turn light.
- Bulb-replaceable unit 343 has 3/8" base and three lead wires: two blunt cut and one ground wire with ring terminal.
- 2757 has lens welded to 9/16" tall base and three lead wires with .180 molded bullets.

Order No.	Description	Pack	Std Carton
343A	amber, bulb replaceable	poly pack	12
M343A	amber, bulb replaceable	mfg. pack	48
2757	amber, welded lens	mfg. pack	48
343-25A	amber lens	poly pack	10
343-241	mounting gasket	mfg. pack	10
3157	replacement bulb		<i>reference only</i>

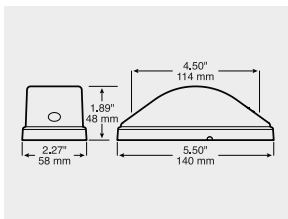

# INCANDESCENT MID-TURN LIGHTS



## 352 Sealed Combination Side Turn Signal & Side Marker



- Amber unit meets SAE recommended practice for side turn signal, while providing side marker light and side reflector functions.
- Popular model commonly referred to as a mid-turn light.
- 421-18 grommet and 3-wire plug are required for installation.
- Kit includes light, 421-18 grommet, and 431-491 plug.
- See part number 421-09 for angle mounting bracket option.
- Meets SAE J2039 requirements for mid-turn lights on large trailers.
- See 356 LED version on page 47.

Order No.	Description	Pack	Std Carton
V352A	amber	Viz Pack	6
352A	amber	poly pack	12
M352A	amber	mfg. pack	48
M352KA	<b>KIT</b> amber kit	mfg. pack	48
421-18	grommet	poly pack	12
B421-18	grommet	mfg. pack	100
421-491	rt. angle plug	poly pack	12
B421-491	rt. angle plug	mfg. pack	100
431-491	plug	poly pack	12
B431-491	plug	mfg. pack	100

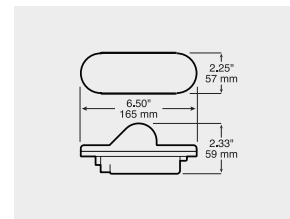

## 426WTA Mid-Trailer, Wide-Turn Signal



- Designed to improve visibility on tractor/trailer applications.
- Features 4" amber turn signal mounted in L-bracket with bright "Caution Wide Turn" graphics.
- Commonly used in mid-turn applications.
- Can be configured for either right- or left-side application.
- Kit includes sign, light, grommet, plug, mounting bracket, and instruction sheet.
- See LED versions on page 41.

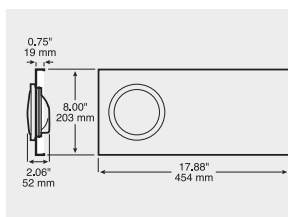

Order No.	Description	Pack	Std Carton
426WTA	amber, wide turn	box	6

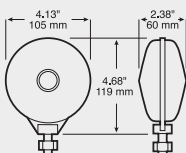

## 313R Single-Face Round Rear Turn Signal



- Pedestal-mount, red single-face turn signal or warning light.
- Durable, black plastic housing will not rust or corrode.
- Snap-on acrylic lens is interchangeable with competitive models.
- Single lead wire exits through 1/2" diameter stud.
- Grounds through mounting stud.

Order No.	Description	Pack	Std Carton
V313R	red	Viz Pack	6
313R	red	poly pack	12
313-15BLK	black back	poly pack	10
313-15R	red lens	poly pack	10
411-07	replacement pigtail	poly pack	25
1156	replacement bulb		<i>reference only</i>

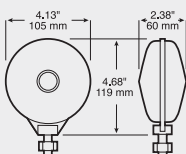

## 313AA Double-Face Round Amber Park & Turn Light



- Pedestal-mount, double face amber light functions as combination turn signal, parking light or warning light.
- Durable, black plastic housing with two snap-on amber lenses.
- Two lead wires exit through 1/2" diameter mounting stud.
- Grounds through mounting stud.
- Converts to single-face amber light by snapping on black back.

Order No.	Description	Pack	Std Carton
V313AA	amber/amber	Viz Pack	6
313AA	amber/amber	poly pack	12
313-15BLK	black back	poly pack	10
313-15A	amber lens	poly pack	10
413-07	replacement pigtail	poly pack	25
2057	replacement bulb		<i>reference only</i>

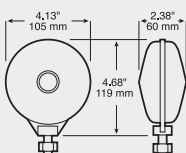

## 313-2 Double-Face Red/Amber Park and Turn Signal



- Pedestal-mount, double-face red/amber light functions as combination turn signal, parking light or warning light.
- Durable, black plastic housing with snap-on red and amber lenses.
- Two lead wires exit through 1/2" diameter mounting stud.
- Grounds through mounting stud.
- Popular style lamp is interchangeable with competitive units.
- Can be converted to single-face by snapping on black back.

Order No.	Description	Pack	Std Carton
V313-2RA	red/amber	Viz Pack	6
313-2RA	red/amber	poly pack	12
313-15BLK	black back	poly pack	10
313-15A	amber lens	poly pack	10
313-15R	red lens	poly pack	10
413-07	replacement pigtail	poly pack	25
2057	replacement bulb		<i>reference only</i>

# TURN SIGNALS



## 308/309 Agricultural Stop/Turn/Tail & Warning Light



- ASAE S279.17 compliant.
- Perfect for all agricultural applications.
- 308 combination lights function as both red stop and tail light and amber turn signal and flashing warning light.
- 309AA functions as turn signal and/or flashing warning light.
- Works with all 12-volt vehicles.
- Can be mounted to vertical or horizontal surfaces.
- Rubber protective gasket seals unit from moisture and dust
- Replaceable bulb and lens.
- Standard version has 4-pin plug (308) or 3-pin plug (309) for easy installation.
- -PKD versions are terminated with Packard-style hardshell connector.
- Replacement lens kits include replacement gasket and screws.
- 309R single red stop/turn/tail light available on page 22.
- See LED versions on pages 17 and 43.

Order No.	Description	Pack	Std Carton
308L	dual, roadside	mfg. pack	16
308L-PKD	dual, roadside w/ hardshell connector	mfg. pack	16
308R	dual, curbside	mfg. pack	16
308R-PKD	dual, curbside w/ hardshell connector	mfg. pack	16
309AA	amber / amber, single	mfg. pack	24
308-15A	amber replacement lens kit	poly pack	50
308-15R	red replacement lens kit	poly pack	50
308-15BLK	black block-off cover	poly pack	50

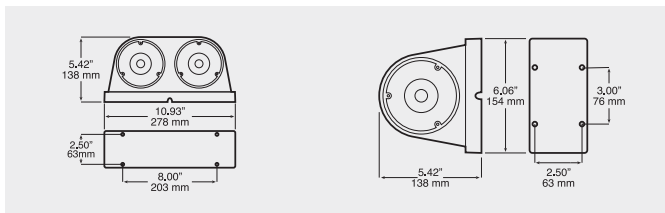

# INCANDESCENT PEDESTAL LIGHTS



Note: Less than 75 sq. cm of effective, projected luminous lens area.  
For use on vehicles under 80" wide.

## 335-2 Double-Faced Turn Signal or Park/Turn Signal



- Features zinc diecast housing with black, powder-coated finish.
- Acrylic lenses are interchangeable with competitive models.
- Grounds through mounting stud.
- 335-2 combination park and turn signal has two lead wires that exit through 1/2" mounting stud.

Order No.	Description	Pack	Std Carton
V335-2	amber/red w/ parking light	Viz Pack	6
M335-2-BT2	amber/red w/ parking light	mfg. pack	12
334-15A	amber lens	poly pack	10
334-15R	red lens	poly pack	10
413-07	pigtail for 335-2	poly pack	25
2057	replacement bulb for 335-2		reference only

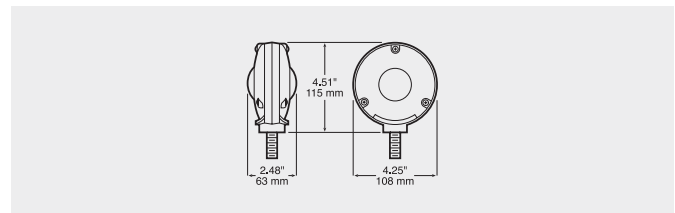



Note: Less than 75 sq. cm of effective, projected luminous lens area.  
For use on vehicles under 80" wide.

## 337-2 Double-Face Round Park & Turn Light



- Features zinc diecast housing with chrome-plated finish.
- Acrylic lenses are interchangeable with competitive models.
- Grounds through mounting stud.
- Park and turn signal leads exit through 1/2" mounting stud.
- See 338-2 LED version on page 42.

Order No.	Description	Pack	Std Carton
337-2	amber/red w/ parking light	poly pack	12
334-15A	amber lens	poly pack	10
334-15R	red lens	poly pack	10
413-07	pigtail	poly pack	25
2057	replacement bulb		<i>reference only</i>

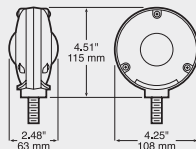

## 344 Double-Face Park & Turn Light w/ Side Marker



- Vertical, two-stud turn signal includes side marker light with reflector.
- Unique weather proof, plug-in harness provides for universal mount, or may be discarded for exact OEM replacement of Navistar 1661280C91.

Order No.	Description	Pack	Std Carton
344A	amber	poly pack	12
344-24	mounting pad	mfg. pack	100
344-49	replacement plug	mfg. pack	12
3157	replacement bulb		<i>reference only</i>

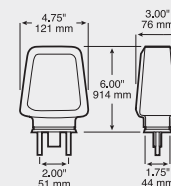

# CLEARANCE/MARKER LIGHTS



## 35 LED Clearance/Side Marker Light



- LED version of Peterson 135 oval surface-mount clearance/marker light.
- Mounts on industry standard 3" centers.
- 9-32 volt operating range.
- Hardwired power and ground leads.
- PC-rated light functions as both clearance and side marker when mounted at a 45° angle.

Order No.	Description	Pack	Std Carton
V35A-BT2	amber, .180 bullets	Viz Pack	6
V35R-BT2	red, .180 bullets	Viz Pack	6
35A-MV	amber, stripped	poly pack	6
35R-MV	red, stripped	poly pack	6
35A-MV-BT2	amber, .180 bullets	poly pack	6
35R-MV-BT2	red, .180 bullets	poly pack	6
M35A-MV	amber, stripped	mfg. pack	100
M35R-MV	red, stripped	mfg. pack	100
M35A-MV-BT2	amber, .180 bullets	mfg. pack	100
M35R-MV-BT2	red, .180 bullets	mfg. pack	100
V134-15A	amber lens	Viz Pack	6
V134-15R	red lens	Viz Pack	6
134-15A	amber lens	poly pack	10
134-15R	red lens	poly pack	10
B134-15A	amber lens	bulk pack	100
B134-15R	red lens	bulk pack	100

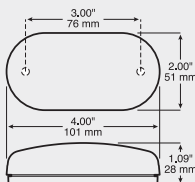

# LED CLEARANCE & SIDE MARKER



## 38 LED Clearance/Side Marker Light



- LED version of Peterson 138 oval surface-mount clearance/marker light.
- Mounts on industry standard 3" centers.
- 9-32 volt operating range.
- Hardwired power and ground leads.
- PC-rated light functions as both clearance and side marker when mounted at a 45° angle.
- Compatible with 106-09 chrome accessory guard. See page 171.

Order No.	Description	Pack	Std Carton
V38A	amber, stripped	Viz Pack	6
V38R	red, stripped	Viz Pack	6
38A-MV	amber, stripped	poly pack	6
38R-MV	red, stripped	poly pack	6
38A-MV-BT2	amber, .180 bullets	poly pack	6
38R-MV-BT2	red, .180 bullets	poly pack	6
M38A-MV	amber, stripped	mfg. pack	100
M38R-MV	red, stripped	mfg. pack	100
M38A-MV-BT2	amber, .180 bullets	mfg. pack	100
M38R-MV-BT2	red, .180 bullets	mfg. pack	100
V138-15A	amber lens	Viz Pack	6
V138-15R	red lens	Viz Pack	6
138-15A	amber lens	poly pack	10
138-15R	red lens	poly pack	10
B138-15A	amber lens	bulk pack	100
B138-15B	blue lens	bulk pack	100
B138-15C	clear lens	bulk pack	100
B138-15G	green lens	bulk pack	100
B138-15R	red lens	bulk pack	100
V106-09	chrome guard	Viz Pack	6
B106-09	chrome guard	mfg. pack	60

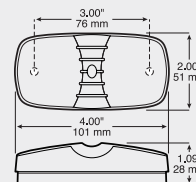



# LED CLEARANCE & SIDE MARKER



## 60 LED Clearance/Side Marker Light



- Mounts on industry-standard 3" centers.
- 9-32 volt operating range.
- Hardwired power and ground leads.
- Thin-line design that fits most narrow rail applications.
- DOT legal when mounted horizontally with up to 20° tilt back.
- Foam mounting gasket available
- Compatible with 160-09 aluminum brush guard. See page 178.

Order No.	Description	Pack	Std Carton
60A-MV	amber	poly pack	12
60R-MV	red	poly pack	12
M60A-MV	amber	mfg. pack	50
M60R-MV	red	mfg. pack	50
160-09	brush guard	poly pack	6
B160-09	brush guard	mfg. pack	120
160-242	gasket	mfg. pack	100

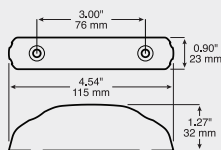

# CLEARANCE/MARKER LIGHTS



## 153 LED Clearance/Side Marker Light



- Lens is welded to housing to form single rugged unit.
- Kits include 153 LED light, 150-095 mounting bracket and plug.
- See mounting accessories section for additional mounting options.
- Meets DOT requirements in any 360° orientation, tilted back to a maximum of 32°.

Order No.	Description	Pack	Std Carton
V153KA	<b>KIT</b> amber kit	Viz Pack	6
V153KR	<b>KIT</b> red kit	Viz Pack	6
153A	amber	poly pack	12
153R	red	poly pack	12
M153A	amber	mfg. pack	50
M153R	red	mfg. pack	50
150-095	black bracket	poly pack	12
B150-18	grommet, 11/64" max thickness	mfg. pack	100
B150-181	grommet, 1/4" max thickness	mfg. pack	100
B153-181	grommet, water sealing	mfg. pack	100
153-49	plug	poly pack	12
B153-49	plug	mfg. pack	100



150-095

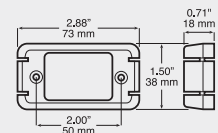
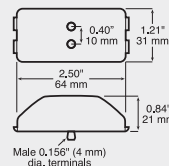

# CLEARANCE/MARKER LIGHTS

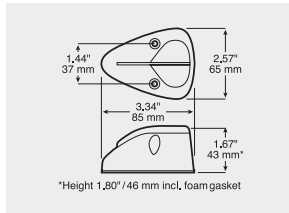

# LED CLEARANCE & SIDE MARKER

## 121 LED Cab Marker Light

**15**  
diodes **HARD WIRED**

- Mounts with two screws on 1 7/16" centers.
- Hardwired design features .180 bullet terminal on hot lead and #10 ring terminal on ground wire.
- Includes neoprene mounting pad for secure, mar-free installation.
- Available in amber only.

Order No.	Description	Pack	Std Carton
121A	amber	poly pack	6
M121A	amber	mfg. pack	50

## 129 LED Clearance/Side Marker Light w/ Reflex

**2**  
diodes **HARD WIRED** **REFLEX**

- OE replacement light for Knapheide truck bodies.
- Kits include white grommet with lights. Black grommet available separately.
- Sealed lens and housing.
- Flush mounts to vehicle.
- Requires grommet to complete installation.

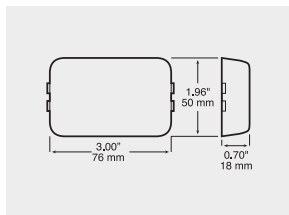

Order No.	Description	Pack	Std Carton
129KA	<b>KIT</b> amber kit w/ white grommet	poly pack	12
129KR	<b>KIT</b> red kit w/ white grommet	poly pack	12
M129A	amber	mfg. pack	100
M129R	red	mfg. pack	100
127-18	black grommet	poly pack	24
B127-18	black grommet	mfg. pack	100

## 133 LED Clearance/Side Marker Light

**3**  
diodes **VIZ PACK** **HARD WIRED**

- Mounts on 3" centers.
- Hardwired design features two .180 bullet-terminals.
- Viz-Pack kits include attractive chrome bezel.
- Meets DOT requirements when mounted perpendicular to the road or tilted back to a maximum of 32°
- Chrome accessory bezel available separately. See page 171.

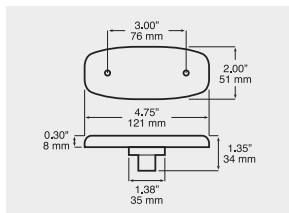

Order No.	Description	Pack	Std Carton
V133XA	<b>KIT</b> amber kit	Viz Pack	6
V133XR	<b>KIT</b> red kit	Viz Pack	6
133A	amber	poly pack	12
133R	red	poly pack	12
M133A	amber	mfg. pack	50
M133R	red	mfg. pack	50
B133-10	chrome bezel	mfg. pack	50

# LED CLEARANCE & SIDE MARKER



## 161 LED Clearance/Side Marker Light



- LED alternative to traditional 154-series incandescent lights.
- 9-16 volt operating range.
- Requires bracket and 2-wire plug, or 154-11K bracket for grounding through mounting screw.
- Kits include light and 154-11K bracket with terminal pad.
- Dual-color M161A-R meets DOT regulations as amber front and red rear clearance light when properly mounted top or side of fender at widest point of trailer or boat, cargo and horse trailers.
- See accessories section for additional plug & mounting options.

Order No.	Description	Pack	Std Carton
V161KA	<b>KIT</b> amber kit	Viz Pack	6
V161KR	<b>KIT</b> red kit	Viz Pack	6
161A	amber	poly pack	12
161R	red	poly pack	12
161KA	<b>KIT</b> amber kit	poly pack	12
161KR	<b>KIT</b> red kit	poly pack	12
M161A	amber	mfg. pack	50
M161R	red	mfg. pack	50
M161A-R	dual-color amber & red	mfg. pack	50
154-09K	gray bracket kit	poly pack	12
154-10K	chrome bracket kit	poly pack	12
154-11K	black bracket kit	poly pack	12
B154-11K	black bracket kit w/terminal pad	mfg. pack	100
B154-11K-BT1	blk kit w/terminal pad, .180 bullet	mfg. pack	100
B154-11	black bracket for use with plug	mfg. pack	100
B153-49	2-wire molded plug w/6" leads	mfg. pack	100



154-09K

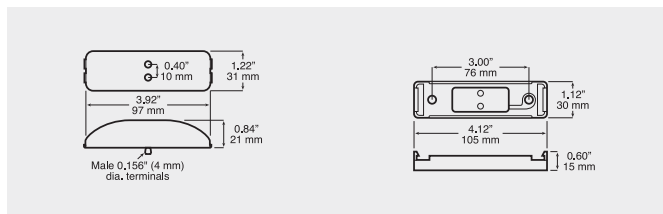

# CLEARANCE/MARKER LIGHTS



## 72/166 LED 2½" & 2" Beehive Clearance/Side Marker Light



- Available in 2" (166A & 166R) and 2-1/2" (72R) diameters
- Features sealed lens and housing.
- Operates from 9–16 volts.
- Requires mounting grommet and 2-wire plug to complete installation.

Order No.	Description	Pack	Std Carton
V72R	2-1/2" red	Viz Pack	3
V166A	2" amber	Viz Pack	6
V166R	2" red	Viz Pack	6
166A	2" amber	poly pack	12
166R	2" red	poly pack	12
M166A	2" amber	mfg. pack	50
M166R	2" red	mfg. pack	50
146-18	2" grommet	poly pack	24
B146-18	2" grommet	mfg. pack	100
143-18	2-1/2" grommet	poly pack	24
B143-18	2-1/2" grommet	mfg. pack	100
162-49	plug	poly pack	12
B162-49	plug	mfg. pack	100

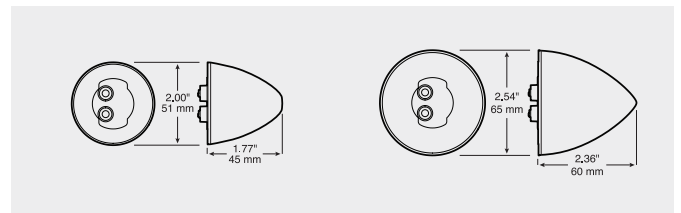

STT

TURN

MARKER

B-U/UTIL

SPEC

EMERG

ECE

MOUNT

ELECT

REFLECT

ACCY

MERCH

TECH



168A & 168R



168XA-MV & 168XR-MV



M168CA-BT2 & M168CR-BT2

## 168 LED

### Mini Clearance/Side Marker Light



- 9-16 volt operating range, 9-32 volts for "-MV" multi-volt units.
- Hardwired with separate lead and ground wires.
- XA/XR versions include B168-10 chrome bezel, also available separately.
- Mounts on 1-15/16" centers; optional B168-09 bracket allows for mounting on either 1-15/16" or 1-1/8" centers.
- 168 series features 5.75" long lead wires.
- 4484 series features 9.5" long lead wires.

Order No.	Description	Pack	Std Carton
V168A	amber	Viz Pack	3
V168R	red	Viz Pack	3
V168XA	<b>KIT</b> amber kit w/ chrome bezel	Viz Pack	6
V168XR	<b>KIT</b> red kit w/ chrome bezel	Viz Pack	6
168A	amber	poly pack	12
168R	red	poly pack	12
168A-MV	amber multivolt	poly pack	12
168R-MV	red multivolt	poly pack	12
168XA-MV	<b>KIT</b> amber mv kit w/ chrome bezel	poly pack	12
168XR-MV	<b>KIT</b> red mv kit w/ chrome bezel	poly pack	12
M168A	amber	mfg. pack	50
M168R	red	mfg. pack	50
M168CA-BT2	amber clear lens w/ .180 bullets	mfg. pack	50
M168CR-BT2	red clear lens w/ .180 bullets	mfg. pack	50
M168A-MV	amber multivolt	mfg. pack	50
M168R-MV	red multivolt	mfg. pack	50
4484A-1	amber w/ two .180 bullets	mfg. pack	50
4484R-1	red w/ two .180 bullets	mfg. pack	50
168-09	black bracket	poly pack	12
B168-09	black bracket	mfg. pack	100
168-092K	<b>KIT</b> alum. brush guard & gasket kit	poly pack	12
B168-092	aluminum brush guard bracket	mfg. pack	100
168-10K	<b>KIT</b> chrome bezel & gasket kit	poly pack	12
B168-10	chrome bezel	mfg. pack	100
168-18	mounting gasket	poly pack	12
B168-18	mounting gasket	mfg. pack	100
B168-181	thinline gasket – use w/ 168-092	mfg. pack	100

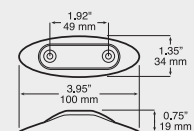
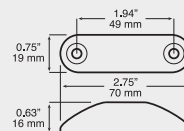



## 169 LED Clearance/Side Marker Light



- Operates from 9-16 volts.
- Features 2-wire, hardwired design.
- Ground wire includes #10 ring terminal.
- Mounts on 3" centers.
- B169-18 mounting gasket included in Viz Pack kits, or available separately.
- One-piece housing sealed with epoxy eliminates weld joints.
- Low cost LED alternative to traditional incandescent 154-series lights.

Order No.	Description	Pack	Std Carton
V169KA	<b>KIT</b> amber kit	Viz Pack	3
V169KR	<b>KIT</b> red kit	Viz Pack	3
169A	amber	poly pack	12
169R	red	poly pack	12
M169A	amber, stripped lead/ring term	mfg. pack	100
M169R	red, stripped lead/ring term	mfg. pack	100
B169-18	gasket	mfg. pack	100



B169-18

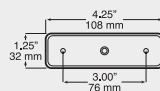
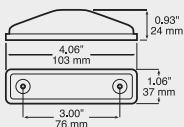

## 170 LED Clearance/Side Marker Light w/ Reflex



- Operates from 9-16 volts.
- Features 2-wire, hardwired design.
- Ground wire terminated with #10 ring terminal
- Stripped hot wire, except -BT1 suffix which is terminated with .180 bullet
- LED alternative to traditional incandescent 114-series lights.
- Two mounting options: use center stud or two mounting screws.
- Center stud provided; screws not included.

Order No.	Description	Pack	Std Carton
V170A	<b>KIT</b> amber kit	Viz Pack	3
V170R	<b>KIT</b> red kit	Viz Pack	3
M170A	amber, stripped lead + ring term.	mfg. pack	50
M170R	red, stripped lead + ring term.	mfg. pack	50
M170A-BT1	amber, .180 bullet + ring term.	mfg. pack	50
M170R-BT1	red, .180 bullet + ring term.	mfg. pack	50

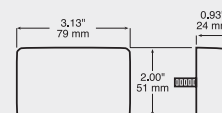

STT

TURN

MARKER

B-U/UTIL

SPEC

EMERG

ECE

MOUNT

ELECT

REFLECT

ACCY

MERCH

TECH



178A/R



178CA/CR



178XA/XR

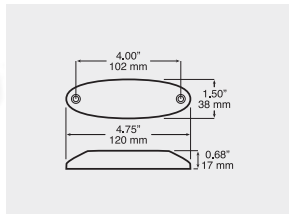

## 178 LED Clearance/Side Marker Light



- Meets DOT requirements for clearance/side marker lights up to 20 degree tilt-back.
- 9-16 volt operating range, 9-32 volts for "-MV" and "-MVC" units.
- Hardwired design available with stripped leads, or with two .180 bullets (-BT2).
- Optional chrome bezel available. See page 182 for dimensions.
- Available with red or amber diodes behind stylish clear lens.
- New hardwired design eliminates the need for plug.
- Mounts on 4" centers.
- Eye-catching Class 8 look makes it a great retrofit choice.
- Kits include light and decorative chrome bezel.

Order No.	Description	Pack	Std Carton
V178A	amber	Viz Pack	6
V178R	red	Viz Pack	6
V178XA	<b>KIT</b> amber kit w/ chrome bezel	Viz Pack	6
V178XR	<b>KIT</b> red kit w/ chrome bezel	Viz Pack	6
178A-MV	amber	poly pack	12
178R-MV	red	poly pack	12
178XA-MV	<b>KIT</b> amber mv kit w/ chrome bezel	poly pack	12
178XR-MV	<b>KIT</b> red mv kit w/ chrome bezel	poly pack	12
M178A	amber	mfg. pack	50
M178R	red	mfg. pack	50
M178A-MV	amber, multi-volt	mfg. pack	50
M178R-MV	red, multi-volt	mfg. pack	50
M178CA-BT2	amber 12V w/clear lens	mfg. pack	50
M178CR-BT2	red 12V w/clear lens	mfg. pack	50
M178A-MVC	amber multi-volt w/clear lens	mfg. pack	50
4354A	amber w/ two .180 bullet term.	mfg. pack	50
4354R	red w/ two .180 bullet terminals	mfg. pack	50
178-10	chrome bezel	poly pack	12
B178-10	chrome bezel	mfg. pack	100

## 180 LED Clearance/Side Marker Light w/ Reflex



- 6-diode oval design.
- Built-in reflector optics eliminate the need for separate reflector.
- Meets DOT lighting requirements.
- Hardwired leads eliminate plug-to-lamp corrosion.
- Mounts with screws on 3" centers.
- Includes both lead and ground wire for mounting to all surfaces.
- Available in amber or red.

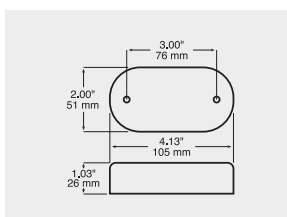

Order No.	Description	Pack	Std Carton
V180A	amber	Viz Pack	3
V180R	red	Viz Pack	3
V2549-15A	replacement lens, amber	Viz Pack	10
V2549-15R	replacement lens, red	Viz Pack	10

# LED CLEARANCE & SIDE MARKER

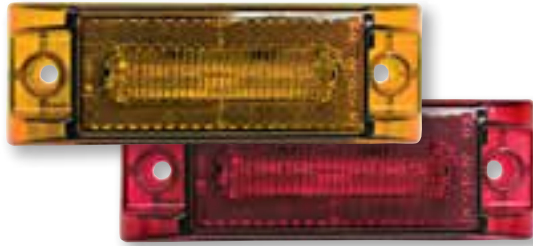

## 187 LED

### Clearance/Side Marker Light w/ Reflex



- PC-rated, 6 diode LED combination light that functions as both clearance and side marker light when mounted at a 45° angle.
- Hardwired design eliminates the need for plug.
- Lens and housing linear welded for durable seal.
- Skirted weld joint provides added protection against moisture.
- 9-16 volt operating range, 9-32 volts for "-MV" multi-volt units.

Order No.	Description	Pack	Std Carton
187A	amber	poly pack	10
187R	red	poly pack	10
187A-MV	amber, multi-volt	poly pack	12
187R-MV	red, multi-volt	poly pack	12
M187A	amber	mfg. pack	50
M187R	red	mfg. pack	50
M187A-MV	amber, multi-volt	mfg. pack	50
M187R-MV	red, multi-volt	mfg. pack	50
M187A-BT2	amber w/ two .180 bullet term.	mfg. pack	50
M187R-BT2	red w/ two .180 bullet terminals	mfg. pack	50

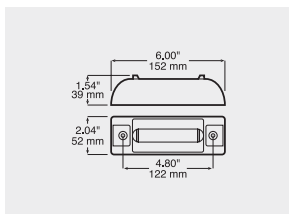
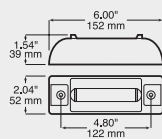

# CLEARANCE/MARKER LIGHTS



## 188 LED

### Clearance/Side Marker Light w/ Reflex



- Sealed, 4-diode LED that offers clearance, side marker or ID light versatility.
- Hardwired design eliminates the need for plug.
- Lens and housing linear welded for durable seal.
- Skirted weld joint provides added protection against moisture.
- Operates from 9-16 volts.

Order No.	Description	Pack	Std Carton
V188A	amber	Viz Pack	6
V188R	red	Viz Pack	6
188A	amber	poly pack	10
188R	red	poly pack	10
M188A	amber	mfg. pack	50
M188R	red	mfg. pack	50

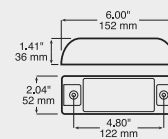

## 353 LED

### Clearance/Side Marker Light w/ Reflex



- PC-rated, 6-diode LED combination light that provides both clearance and side marker functions when mounted at a 45° angle.
- Third wire provides auxiliary turn function for enhanced safety.
- Can also be used as a mid marker light.
- Hardwired design eliminates the need for plug.
- Lens and housing linear welded for durable seal.
- Skirted weld joint provides added protection against moisture.
- 9-16 volt operating range.

Order No.	Description	Pack	Std Carton
M353A	amber	mfg. pack	50
M353R	red	mfg. pack	50

STT

TURN

MARKER

B-U/UTIL

SPEC

EMERG

ECE

MOUNT

ELECT

REFLECT

ACCY

MERCH

TECH



"-AMP" rear



## 173 LED 2 1/2" Clearance/Side Marker w/ Reflex



- Round, 2-1/2" diameter.
- Accepts industry standard PL10 2-wire plug or AMP plug ("-AMP")
- DOT-legal integral reflex function.
- "-AMP" versions have 5 diodes and integrated receptacle for AMP-style sealed connector
- 142-18 grommet & appropriate plug required for installation.

Order No.	Description	Pack	Std Carton
173A	amber	poly pack	12
173R	red	poly pack	12
M173A	amber	mfg. pack	50
M173R	red	mfg. pack	50
M173A-AMP	amber, AMP-style receptacle	mfg. pack	50
M173R-AMP	red, AMP-style receptacle	mfg. pack	50
142-18	grommet	poly pack	24
B142-18	grommet	mfg. pack	100
142-49	right angle plug	poly pack	12
B142-49	right angle plug	mfg. pack	100
162-49	PL10 plug	poly pack	12
B162-49	PL10 plug	mfg. pack	100
192-492	AMP-style plug	poly pack	6
B192-492	AMP-style plug	mfg. pack	50

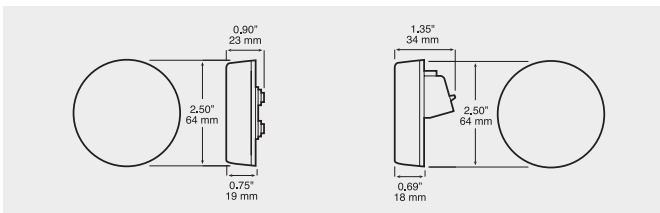

## 175 LED Single Diode 2 1/2" Clearance/Side Marker w/ Reflex



- Round, 2-1/2" diameter in grommet or flange mount versions.
- Single diode design.
- Accepts industry standard 2-wire plug.
- DOT-legal integral reflex function.
- 142-18 grommet & appropriate plug required for installation.

Order No.	Description	Pack	Std Carton
175A	amber	poly pack	12
175R	red	poly pack	12
M175A	amber	mfg. pack	50
M175R	red	mfg. pack	50
M175FA	amber, flange mount	mfg. pack	50
M175FR	red, flange mount	mfg. pack	50
142-18	grommet	poly pack	24
B142-18	grommet	mfg. pack	100
142-49	right angle plug	poly pack	12
B142-49	right angle plug	mfg. pack	100
162-49	plug	poly pack	12
B162-49	plug	mfg. pack	100

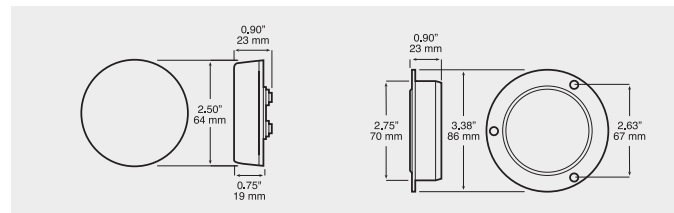



# LED CLEARANCE & SIDE MARKER



## 189 LED Single Diode 2 1/2" Clearance/Side Marker w/ Reflex



- 2-1/2" diameter LED light with traditional incandescent lens look.
- Popular for chassis applications.
- Accepts industry standard PL10 2-wire plug or AMP plug ("-AMP")
- DOT-legal integral reflex function.
- Fits metric size mounting holes.
- 9-16 voltage operating range.
- Protective gasket included.

Order No.	Description	Pack	Std Carton
189FA	amber, PL10 connector	poly pack	12
189FR	red, PL10 connector	poly pack	12
M189FA	amber, PL10 connector	mfg. pack	50
M189FR	red, PL10 connector	mfg. pack	50
M189FA-AMP	amber, AMP-style receptacle	mfg. pack	50
M189FR-AMP	red, AMP-style receptacle	mfg. pack	50
M189FA-CLP	amber, PL10 w/ integrated clip	mfg. pack	50
M189FR-CLP	red, PL10 w/ integrated clip	mfg. pack	50
189 24	replacement gasket	mfg. pack	1
B162-093	stainless plug retention clip	mfg. pack	100
162-49	PL10 plug	poly pack	12
B162-49	PL10 plug	mfg. pack	100
B192-492	AMP plug w/ .180 bullets	mfg. pack	50
B192-493	AMP plug w/ blunt cut leads	mfg. pack	50



B162-093 retention clip  
(Not for use with "-AMP" or "-CLP" versions)



"-CLP" rear



"-AMP" rear

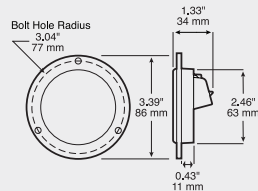
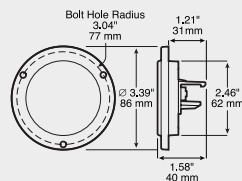
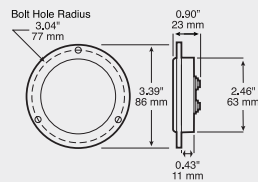

# CLEARANCE/MARKER LIGHTS



## 190 LED Single Diode 2" Clearance/Side Marker w/ Reflex



- 2" diameter LED light with traditional incandescent lens look.
- Popular for chassis applications.
- Accepts industry standard PL10 2-wire plug or AMP plug ("-AMP")
- DOT-legal integral reflex function.
- Fits metric size mounting holes.
- 9-16 voltage operating range.
- Protective gasket included.

Order No.	Description	Pack	Std Carton
190FA	amber, PL10 connector	poly pack	12
190FR	red, PL10 connector	poly pack	12
M190FA	amber, PL10 connector	mfg. pack	50
M190FR	red, PL10 connector	mfg. pack	50
M190FA-AMP	amber, AMP-style receptacle	mfg. pack	50
M190FR-AMP	red, AMP-style receptacle	mfg. pack	50
M190FA-CLP	amber, PL10 w/ integrated clip	mfg. pack	50
M190FR-CLP	red, PL10 w/ integrated clip	mfg. pack	50
140 24	replacement gasket	mfg. pack	1
B162-093	stainless plug retention clip	mfg. pack	100
162-49	PL10 plug	poly pack	12
B162-49	PL10 plug	mfg. pack	100
B192-492	AMP plug w/ .180 bullets	mfg. pack	50
B192-493	AMP plug w/ blunt cut leads	mfg. pack	50



B162-093 retention clip  
(Not for use with "-AMP" or "-CLP" versions)



"-CLP" rear

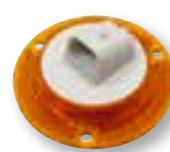

"-AMP" rear

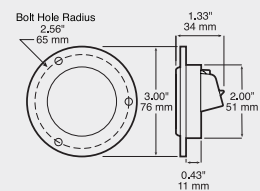
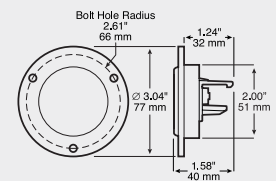
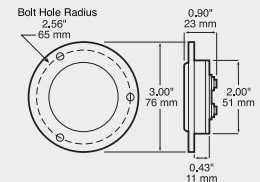

# CLEARANCE/MARKER LIGHTS



Integrated receptacle accepts AMP-style sealed connector

## 192 LED 2 1/2" Clearance/Side Marker Light



- 2-1/2" diameter.
- Integrated receptacle accepts AMP-style sealed connector.
- 9-16 volt operating range.
- Requires plug for installation.
- Non-flanged units require 142-18 grommet required for installation.
- See mounting accessories section for additional mounting options.

Order No.	Description	Pack	Std Carton
192A	amber	poly pack	12
192R	red	poly pack	12
192FA	amber, flange mount	poly pack	12
192FR	red, flange mount	poly pack	12
192ABS	amber w/ ABS decal	poly pack	12
M192A	amber	mfg. pack	50
M192R	red	mfg. pack	50
M192FA	amber, flange mount	mfg. pack	50
M192FR	red, flange mount	mfg. pack	50
M192SA	amber, surface mount	mfg. pack	50
M192SR	red, surface mount	mfg. pack	50
142-18	grommet	poly pack	24
B142-18	grommet	mfg. pack	100
192-492	plug w/ .180 bullets	poly pack	6
B192-492	plug w/ .180 bullets	mfg. pack	50
B192-493	AMP plug w/ blunt cut leads	mfg. pack	50

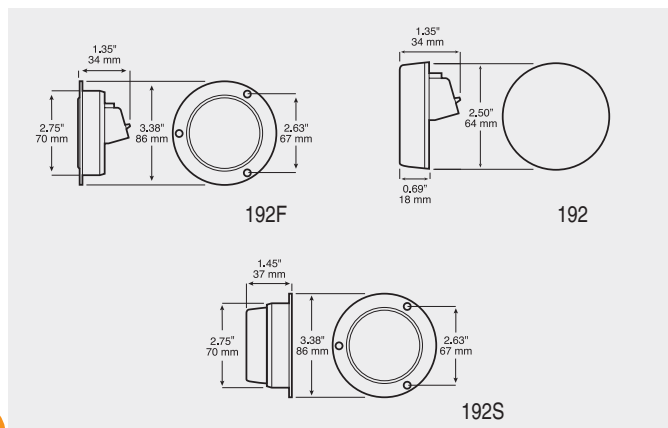

# LED CLEARANCE & SIDE MARKER



## 162 LED 2 1/2" Clearance/Side Marker Light



- Accepts industry standard 2-prong plug.
- 9-16 volt operating range.
- Available in grommet, flange and surface-mount versions.
- Visual pack kits include LED light, 142-18 grommet and 162-49 plug.
- See mounting accessories section for additional mounting options.

Order No.	Description	Pack	Std Carton
V162KA	<b>KIT</b> amber kit	Viz Pack	6
V162KR	<b>KIT</b> red kit	Viz Pack	6
162A	amber	poly pack	12
162R	red	poly pack	12
M162A	amber	mfg. pack	50
M162R	red	mfg. pack	50
M162FA	amber, flange mount	mfg. pack	50
M162FR	red, flange mount	mfg. pack	50
M162SA	amber, surface mount	mfg. pack	50
M162SR	red, surface mount	mfg. pack	50
142-18	grommet	poly pack	24
B142-18	grommet	mfg. pack	100
V162-49	plug	Viz Pack	6
162-49	plug	poly pack	12
B162-49	plug	mfg. pack	100

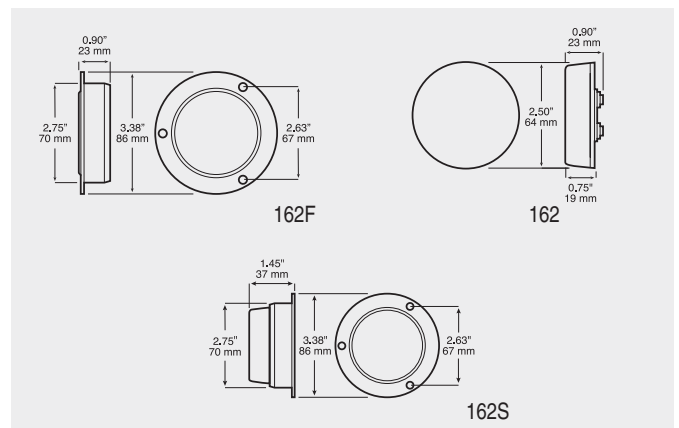

# LED CLEARANCE & SIDE MARKER



Integrated receptacle accepts AMP-style sealed connector

## 193 LED

### 2½" PC-Rated Clearance & Side Marker Light



- Functions as clearance & side marker light when mounted at 45° angle.
- Integrated receptacle accepts AMP-style sealed connector.
- 9-16 volt operating range, 9-32 volts for "-MV" multi-volt units.
- Does not require "top" mounting.
- 143-18 grommet and compatible plug required for installation.
- See mounting accessories section for additional mounting options.

Order No.	Description	Pack	Std Carton
193A	amber	poly pack	12
193R	red	poly pack	12
193FA	amber, flange mount	poly pack	12
193FR	red, flange mount	poly pack	12
M193A	amber	mfg. pack	50
M193R	red	mfg. pack	50
M193A-MV	amber multi-volt	mfg. pack	50
M193R-MV	red, multi-volt	mfg. pack	50
M193FA	amber, flange mount	mfg. pack	50
M193FR	red, flange mount	mfg. pack	50
M193FCA	amber w/ clear lens, flange	mfg. pack	50
M193FCR	red w/ clear lens, flange	mfg. pack	50
M193SA	amber, surface mount	mfg. pack	50
M193SR	red, surface mount	mfg. pack	50
M193SCR	red w/ clear lens, surface mnt.	mfg. pack	50
143-18	grommet	poly pack	24
B143-18	grommet	mfg. pack	100
192-492	AMP plug w/ .180 bullets	poly pack	6
B192-492	AMP plug w/ .180 bullets	mfg. pack	50
B192-493	AMP plug w/ blunt cut leads	mfg. pack	50

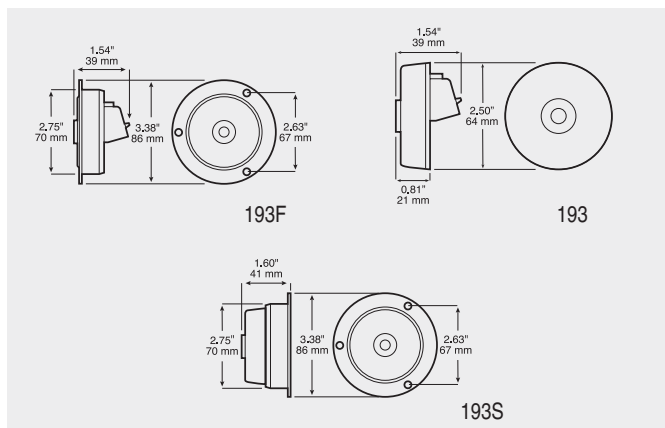

# CLEARANCE/MARKER LIGHTS



## 163 LED

### 2½" PC-Rated Clearance & Side Marker Light



- Functions as both clearance and side marker light when mounted at a 45° angle. Use 143-18 grommet for PC-rated installation.
- Accepts industry standard 2-prong plug.
- 9-16 volt operating range, 9-32 volts for "-MV" multi-volt units.
- Does not require "top" mounting.
- Kits include LED light, 143-18 grommet and 162-49 plug.

Order No.	Description	Pack	Std Carton
163A	amber	poly pack	12
163R	red	poly pack	12
163A-MV	amber multi-volt	poly pack	12
163R-MV	red, multi-volt	poly pack	12
163FA-MV	amber, flange mount, multi-volt	poly pack	12
163FR-MV	red, flange mount, multi-volt	poly pack	12
163KA-MV	<b>KIT</b> amber kit, multi-volt	poly pack	12
163KR-MV	<b>KIT</b> red kit, multi-volt	poly pack	12
M163A	amber	mfg. pack	50
M163R	red	mfg. pack	50
M163A-MV	amber multi-volt	mfg. pack	50
M163R-MV	red, multi-volt	mfg. pack	50
M163FA	amber, flange mount	mfg. pack	50
M163FR	red, flange mount	mfg. pack	50
M163FA-MV	amber, flange mount, multi-volt	mfg. pack	50
M163FR-MV	red, flange mount, multi-volt	mfg. pack	50
M163SA	amber, surface mount	mfg. pack	50
M163SR	red, surface mount	mfg. pack	50
143-18	grommet	poly pack	24
B143-18	grommet	mfg. pack	100
162-49	plug	poly pack	12
B162-49	plug	mfg. pack	100

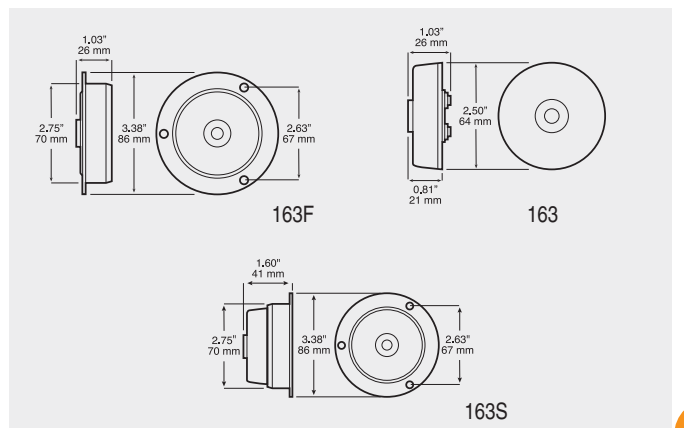

# CLEARANCE/MARKER LIGHTS



Integrated receptacle  
accepts AMP-style  
sealed connector

## 194 LED 2" Clearance/Side Marker Light



- 2" diameter.
- Integrated receptacle accepts AMP-style sealed connector.
- 9-16 volt operating range.
- Non-flanged units require 146-18 grommet for installation.
- See mounting accessories section for additional mounting options.

Order No.	Description	Pack	Std Carton
194A	amber	poly pack	12
194R	red	poly pack	12
194FA	amber, flange mount	poly pack	12
194FR	red, flange mount	poly pack	12
M194A	amber	mfg. pack	50
M194R	red	mfg. pack	50
M194FA	amber, flange mount	mfg. pack	50
M194FR	red, flange mount	mfg. pack	50
146-18	grommet	poly pack	24
B146-18	grommet	mfg. pack	100
192-492	AMP plug w/ .180 bullets	poly pack	6
B192-492	AMP plug w/ .180 bullets	mfg. pack	50
B192-493	AMP plug w/ blunt cut leads	mfg. pack	50

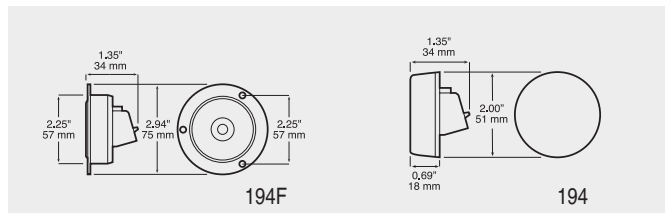

# LED CLEARANCE & SIDE MARKER



## 164 LED 2" Clearance/Side Marker Light



- Accepts industry standard 2-prong plug.
- 9-16 volt operating range.
- Available in grommet, flange and surface-mount versions.
- Visual pack kits include LED light, 146-18 grommet and 162-49 plug.
- See mounting accessories section for additional mounting options.

Order No.	Description	Pack	Std Carton
V164KA	<b>KIT</b> amber kit	Viz Pack	6
V164KR	<b>KIT</b> red kit	Viz Pack	6
164A	amber	poly pack	12
164R	red	poly pack	12
M164A	amber	mfg. pack	50
M164R	red	mfg. pack	50
M164FA	amber, flange mount	mfg. pack	50
M164FR	red, flange mount	mfg. pack	50
M164SA	amber, surface mount	mfg. pack	50
M164SR	red, surface mount	mfg. pack	50
146-18	grommet	poly pack	24
B146-18	grommet	mfg. pack	100
162-49	plug	poly pack	12
B162-49	plug	mfg. pack	100

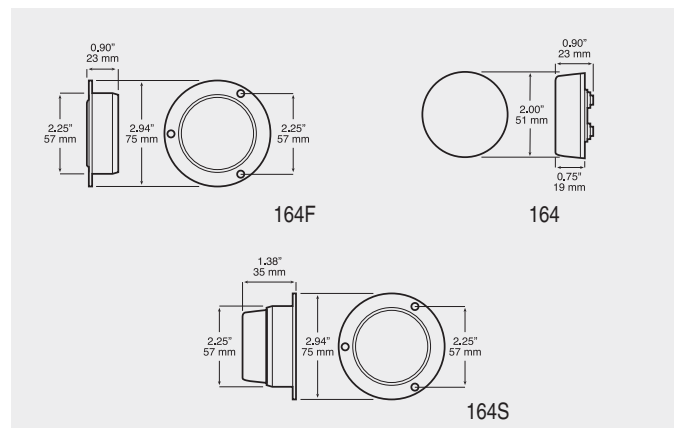

# LED CLEARANCE & SIDE MARKER



Integrated receptacle accepts AMP-style sealed connector

## 195 LED 2" PC-Rated Clearance & Side Marker Light



- Functions as clearance & side marker light when mounted at 45° angle.
- Integrated receptacle accepts AMP-style sealed connector.
- Does not require "top" mounting.
- 9-16 volt operating range, 9-32 volts for "-MV" multi-volt units.
- Non-flanged units require 146-18 grommet for installation.
- See mounting accessories section for additional mounting options.

Order No.	Description	Pack	Std Carton
195A	amber	poly pack	12
195R	red	poly pack	12
195FA	amber, flange mount	poly pack	12
195FR	red, flange mount	poly pack	12
M195A	amber	mfg. pack	50
M195R	red	mfg. pack	50
M195A-MV	amber, multi-volt	mfg. pack	50
M195R-MV	red, multi-volt	mfg. pack	50
M195FA	amber, flange mount	mfg. pack	50
M195FR	red, flange mount	mfg. pack	50
146-18	grommet	poly pack	24
B146-18	grommet	mfg. pack	100
192-492	AMP plug w/ .180 bullets	poly pack	6
B192-492	AMP plug w/ .180 bullets	mfg. pack	50
B192-493	AMP plug w/ blunt cut leads	mfg. pack	50

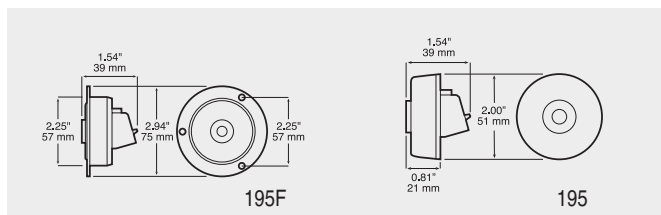

# CLEARANCE/MARKER LIGHTS



## 165 LED 2" PC-Rated Clearance & Side Marker Light



- Functions as both clearance and side marker light when mounted at a 45° angle. Use 146-18 grommet for PC-rated installation.
- Does not require "top" mounting.
- Accepts industry standard 2-prong plug.
- 9-16 volt operating range, 9-32 volts for "-MV" multi-volt units.
- Available in grommet, flange and surface-mount versions.
- Kits include LED light, 146-18 grommet and 162-49 plug.

Order No.	Description	Pack	Std Carton
165A	amber	poly pack	12
165R	red	poly pack	12
165A-MV	amber, multi-volt	poly pack	12
165R-MV	red, multi-volt	poly pack	12
165KA-MV	<b>KIT</b> amber kit, multi-volt	poly pack	12
165KR-MV	<b>KIT</b> red kit, multi-volt	poly pack	12
165FA-MV	amber, flange mount, multi-volt	poly pack	12
165FR-MV	red, flange mount, multi-volt	poly pack	12
M165A	amber	mfg. pack	50
M165R	red	mfg. pack	50
M165A-MV	amber, multi-volt	mfg. pack	50
M165R-MV	red, multi-volt	mfg. pack	50
M165FA	amber, flange mount	mfg. pack	50
M165FR	red, flange mount	mfg. pack	50
M165FA-MV	amber, flange mount, multi-volt	mfg. pack	50
M165FR-MV	red, flange mount, multi-volt	mfg. pack	50
M165SA	amber, surface mount	mfg. pack	50
M165SR	red, surface mount	mfg. pack	50
M165SA-MV	amber, surface mount, multi-volt	mfg. pack	50
M165SR-MV	red, surface mount, multi-volt	mfg. pack	50
B146-18	grommet	mfg. pack	100
B162-49	plug	mfg. pack	100

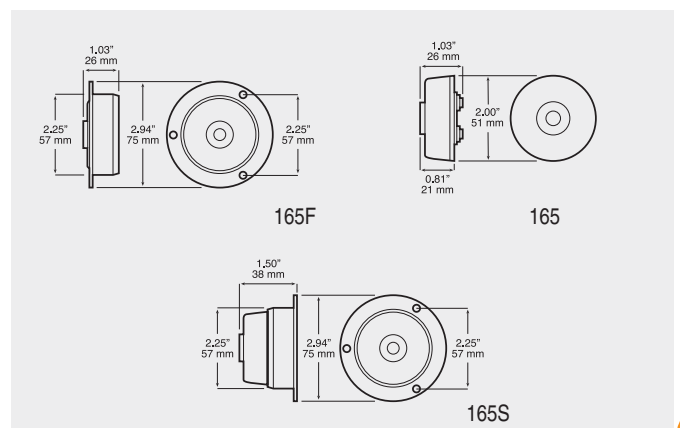



196ABS

## 196 Single Diode LED 2½" Clearance/Side Marker Light



- Single white diode behind colored lens for traditional incandescent lens look.
- Accepts industry standard 2-wire plug.
- 9-16 volt operating range.
- Visual pack kits include 142-18 grommet & 162-49 plug.

Order No.	Description	Pack	Std Carton
V196KA	<b>KIT</b> amber kit	Viz Pack	6
V196KR	<b>KIT</b> red kit	Viz Pack	6
196A	amber	poly pack	12
196R	red	poly pack	12
M196A	amber	mfg. pack	50
M196R	red	mfg. pack	50
M196ABS	<b>KIT</b> amber w/ ABS decal	mfg. pack	50
142-18	grommet	poly pack	24
B142-18	grommet	mfg. pack	100
162-49	plug	poly pack	12
B162-49	plug	mfg. pack	100



197

197F

197-AMP

197F-AMP

## 197 Single Diode LumenX® LED 2½" PC-Rated Clearance & Side Marker Light



- Single white diode behind colored lens for traditional incandescent lens look.
- Functions as both clearance & side marker light when mounted at 45° angle.
- Accepts industry standard PL10 2-wire plug or AMP plug ("-AMP")
- 9-16 volt operating range.

Order No.	Description	Pack	Std Carton
197A	amber, grommet	poly pack	12
197R	red, grommet	poly pack	12
197KA	<b>KIT</b> amber, grommet	poly pack	12
197KR	<b>KIT</b> red, grommet	poly pack	12
197KFA	<b>KIT</b> amber, flange	poly pack	12
197KFR	<b>KIT</b> red, flange	poly pack	12
M197A	amber, grommet	mfg. pack	50
M197A-AMP	amber, grommet, AMP receptacle	mfg. pack	50
M197FA	amber, flange	mfg. pack	50
M197FA-AMP	amber, flange, AMP receptacle	mfg. pack	50
M197R	red, grommet	mfg. pack	50
M197R-AMP	red, grommet, AMP receptacle	mfg. pack	50
M197FR	red, flange	mfg. pack	50
M197FR-AMP	red, flange, AMP receptacle	mfg. pack	50
M197G-AMP	green, AMP receptacle	mfg. pack	50
143-18	grommet	poly pack	24
B143-18	grommet	mfg. pack	100
162-49	plug	poly pack	12
B162-49	plug	mfg. pack	100
192-492	AMP plug w/ .180 bullets	poly pack	6
B192-492	AMP plug w/ .180 bullets	mfg. pack	50
B192-493	AMP plug w/ blunt cut leads	mfg. pack	50

# LED CLEARANCE & SIDE MARKER

# CLEARANCE/MARKER LIGHTS



## 198 Single Diode LED 2" Clearance/Side Marker Light



- Single white diode behind colored lens for traditional incandescent lens look.
- Round, 2" dia.
- Accepts industry standard 2-wire plug.
- 9-16 volt operating range.
- Visual pack kits include LED light, 146-18 grommet and 162-49 plug.

Order No.	Description	Pack	Std Carton
V198KA	<b>KIT</b> amber kit	Viz Pack	6
V198KR	<b>KIT</b> red kit	Viz Pack	6
198A	amber	poly pack	12
198R	red	poly pack	12
M198A	amber	mfg. pack	50
M198R	red	mfg. pack	50
M198ABS	<b>KIT</b> amber w/ ABS decal	mfg. pack	50
146-18	grommet	poly pack	24
B146-18	grommet	mfg. pack	100
162-49	plug	poly pack	12
B162-49	plug	mfg. pack	100

## 199 Single Diode LumenX® LED 2" PC-Rated Clearance & Side Marker Light



- Single white diode behind colored lens for traditional incandescent lens look.
- Round, 2" diameter.
- Functions as both clearance & side marker light when mounted at 45° angle.
- Single-diode design with white diode behind colored lens.
- Accepts industry standard PL10 2-wire plug or AMP plug ("AMP")
- 9-16 volt operating range.

Order No.	Description	Pack	Std Carton
199KA	<b>KIT</b> amber, grommet	poly pack	12
199KR	<b>KIT</b> red, grommet	poly pack	12
199KFA	<b>KIT</b> amber, flange	poly pack	12
199KFR	<b>KIT</b> red, flange	poly pack	12
M199A	amber, grommet	mfg. pack	50
M199A-AMP	amber, grommet, AMP receptacle	mfg. pack	50
M199FA	amber, flange	mfg. pack	50
M199FA-AMP	amber, flange, AMP receptacle	mfg. pack	50
M199R	red, grommet	mfg. pack	50
M199R-AMP	red, grommet, AMP receptacle	mfg. pack	50
M199FR	red, flange	mfg. pack	50
M199FR-AMP	red, flange, AMP receptacle	mfg. pack	50
146-18	grommet	poly pack	24
B146-18	grommet	mfg. pack	100
162-49	plug	poly pack	12
B162-49	plug	mfg. pack	100
192-492	AMP plug w/ .180 bullets	poly pack	6
B192-492	AMP plug w/ .180 bullets	mfg. pack	50
B192-493	AMP plug w/ blunt cut leads	mfg. pack	50

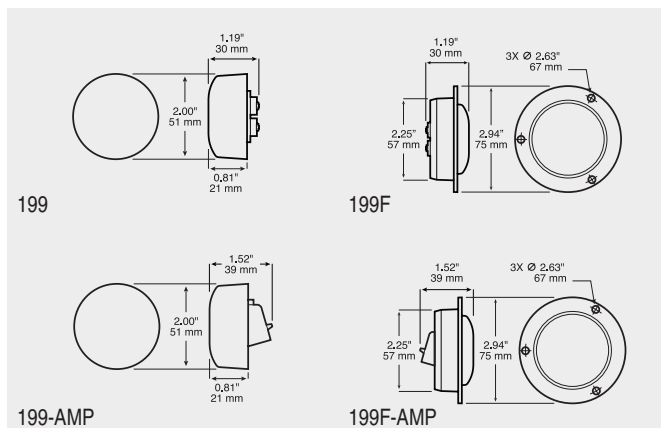

STT  
TURN  
MARKER  
B-U/UTIL  
SPEC  
EMERG  
ECE  
MOUNT  
ELECT  
REFLECT  
ACCY  
MERCH  
TECH

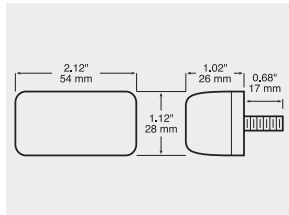

## 191 LED Clearance/Side Marker Light



- Equipped with 2 diodes behind colored transparent lens.
- Lens is welded to housing to form single unit.
- Equipped with single hardwired lead wire.
- Mounting stud serves as ground when mounted to metallic surface.

Order No.	Description	Pack	Std Carton
M191A	amber	mfg. pack	50
M191R	red	mfg. pack	50

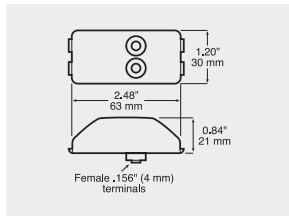

## 203 LED PC-Rated Clearance & Side Marker Light



- Polycarbonate lens and base are welded together to form a single rugged unit.
- LED version of our popular 150 series light.
- See mounting accessories section for additional mounting options.

Order No.	Description	Pack	Std Carton
203A	amber	poly pack	12
203R	red	poly pack	12
M203A	amber	mfg. pack	50
M203R	red	mfg. pack	50
150-09	black bracket	poly pack	12
142-49	plug	poly pack	12
B142-49	plug	mfg. pack	100

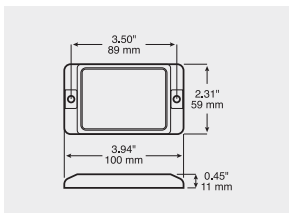

## 215 Single Diode LED Clearance/Side Marker Light w/ Reflex



- Low profile design.
- Single-diode, surface-mount LED clearance/side marker light with integral reflex, eliminating the need for separate reflector.
- New patented conductive plastic design, U.S. Patent No. 8,057,067
- Single lead wire for electrical connection.
- Grounds through the mounting screw.
- 9-16 volt operating range.
- 3-year warranty.

Order No.	Description	Pack	Std Carton
V215A	amber	Viz Pack	6
V215R	red	Viz Pack	6
M215A	amber	mfg. pack	100
M215R	red	mfg. pack	100
215-15A	amber replacement lens	mfg. pack	10
215-15R	red replacement lens	mfg. pack	10



# LED CLEARANCE & SIDE MARKER

# CLEARANCE/MARKER LIGHTS



Optional B388-09X chrome bracket



## 388 LED Clearance/Side Marker Light



- Includes black bracket for surface mounting.
- Can be recess-mounted without bracket.
- Wires exit in center of light.
- Multi-volt design is compatible with both 12 and 24 volt systems.
- Optional chrome bracket available separately.
- See page 118 for matching white and blue utility lights.

Order No.	Description	Pack	Std Carton
388A	amber	poly pack	12
388R	red	poly pack	12
M388A	amber	mfg. pack	10
M388R	red	mfg. pack	10
388-09X	chrome bracket	poly pack	12
B388-09X	chrome bracket	mfg. pack	50

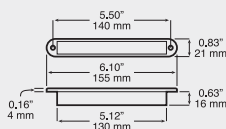

## 277K LED Fender-Mount Combo Clearance/Side Marker



- Dual single-diode 3/4" LED lights in low-profile combination bracket.
- Forward-facing amber and rear-facing red lights in a single unit.
- Surface-mount design mounts easily with three screws (not included).
- Rugged, corrosion-resistant bracket made of thick, rigid black plastic.
- Low profile shape with smooth, rounded corners resists snagging.
- Wire junctions completely sealed in thick urethane potting material.
- 9-16 voltage operating range.
- Max current draw 0.2A@12V.

Order No.	Description	Pack	Std Carton
M277K	curbside	mfg. pack	100
M277KL	roadside	mfg. pack	100
M277K-BT2	curbside w/.180 bullets	mfg. pack	100
M277KL-BT2	roadside w/.180 bullets	mfg. pack	100

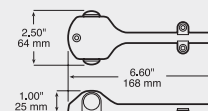

# CLEARANCE/MARKER LIGHTS



## 171/271 LED 3/4" Clearance/Side Marker Light



- Compact single diode design fits 3/4" hole.
- Meets DOT requirements for clearance, side marker and ID lights.
- Compatible with all 12 volt systems.
- Hardwired 8" leads available stripped, or with .180 bullets.
- 271 versions have 3-wire design feature standard clearance/marker plus high-intensity function useful for use as auxiliary CHMSL.
- Includes rubber mounting grommet.

Order No.	Description	Pack	Std Carton
V171A	<b>KIT</b> amber w/ grommet	Viz Pack	3
V171R	<b>KIT</b> red w/ grommet	Viz Pack	3
171KA	<b>KIT</b> amber w/ grommet	poly pack	12
171KR	<b>KIT</b> red w/ grommet	poly pack	12
271KA	<b>KIT</b> amber 3-wire w/ grommet	poly pack	6
271KR	<b>KIT</b> red 3-wire w/ grommet	poly pack	6
271KA-BT3	<b>KIT</b> amber w/.180 bullets & grommet	poly pack	6
271KR-BT3	<b>KIT</b> red w/.180 bullets & grommet	poly pack	6
M171A	<b>KIT</b> amber w/ grommet	mfg. pack	50
M171R	<b>KIT</b> red w/ grommet	mfg. pack	50
M171A-P	<b>KIT</b> amber w/ plug & grommet	mfg. pack	50
M171R-P	<b>KIT</b> red w/ plug & grommet	mfg. pack	50
M171A-BT2	<b>KIT</b> amber w/.180 bullets & grommet	mfg. pack	50
M171R-BT2	<b>KIT</b> red w/.180 bullets & grommet	mfg. pack	50
M271A	<b>KIT</b> amber 3-wire w/ grommet	mfg. pack	50
M271R	<b>KIT</b> red 3-wire w/ grommet	mfg. pack	50
M271A-BT3	<b>KIT</b> amber 3-wire w/.180 bullets, grmt	mfg. pack	50
M271R-BT3	<b>KIT</b> red 3-wire w/.180 bullets, grmt	mfg. pack	50
M271A-AMP	<b>KIT</b> amber 3-wire w/ AMP plug, grmt.	mfg. pack	50
M271R-AMP	<b>KIT</b> red 3-wire w/ AMP plug, grmt.	mfg. pack	50

See pages 180–183 for additional mounting options.

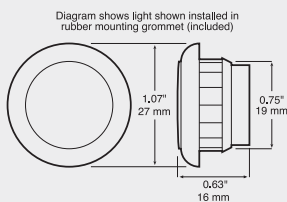

# LED CLEARANCE & SIDE MARKER



## 176 LED 3/4" PC-Rated Clearance & Side Marker Light



- Compact single diode design fits 3/4" hole.
- Has theft-deterrent security feature when properly mounted.
- Functions as clearance and side marker light when properly installed.
- Compatible with all 12 volt systems.
- Hardwired 8" leads available stripped, with .180 bullets, or AMP-style connector.
- Compatible grommet or bracket required for installation.
- Includes rubber mounting grommet.
- Does not require top mounting.
- 176BKA & 176BKR kits include light, grommet and 176-10 surface-mount bracket.
- 176KA-ABS kit includes light w/ bullets, grommet, and ABS decal.

Order No.	Description	Pack	Std Carton
176KA	<b>KIT</b> amber, .180 bullets & grommet	poly pack	6
176KR	<b>KIT</b> red, .180 bullets & grommet	poly pack	6
176BKA	<b>KIT</b> amber w/ bracket & grommet	poly pack	6
176BKR	<b>KIT</b> red w/ bracket & grommet	poly pack	6
176KA-AMP	<b>KIT</b> amber, AMP-style & grommet	poly pack	12
176KR-AMP	<b>KIT</b> red, AMP-style & grommet	poly pack	12
176KA-ABS	<b>KIT</b> amber abs light w/ grommet	poly pack	6
M176A	<b>KIT</b> amber, stripped leads & grommet	mfg. pack	50
M176R	<b>KIT</b> red, stripped leads & grommet	mfg. pack	50
M176A-AMP	<b>KIT</b> amber, AMP-style & grommet	mfg. pack	50
M176R-AMP	<b>KIT</b> red, AMP-style & grommet	mfg. pack	50
M176A-BT2	<b>KIT</b> amber w/.180 bullets & grommet	mfg. pack	50
M176R-BT2	<b>KIT</b> red w/.180 bullets & grommet	mfg. pack	50
B177-18	grommet	mfg. pack	100

See pages 180–183 for additional mounting options.

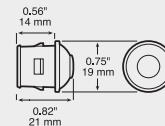

# LED CLEARANCE & SIDE MARKER



## 177 LED

### 3/4" PC-Rated Clearance & Side Marker Light



- Functions as clearance and side marker light when properly installed.
- Compatible with all 12 volt systems.
- 8" (200 mm) hardwired leads available stripped, with .180 bullets, or AMP-style connector.
- Does not require top mounting.
- Includes rubber mounting grommet.

Order No.	Description	Pack	Std Carton
M177A	amber	mfg. pack	50
M177R	red	mfg. pack	50
M177A-AMP	amber, AMP-style & grommet	mfg. pack	50
M177R-AMP	red, AMP-style & grommet	mfg. pack	50
M177A-BT2	amber w/.180 bullets	mfg. pack	50
M177R-BT2	red w/.180 bullets	mfg. pack	50
M177CA-BT2	amber w/ clear lens &.180 bullets	mfg. pack	50
M177CR-BT2	red w/ clear lens &.180 bullets	mfg. pack	50
B177-18	grommet	mfg. pack	100

See pages 180–183 for additional mounting options.

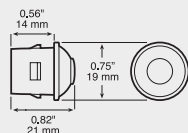

# CLEARANCE/MARKER LIGHTS



## 181 LED

### 3/4" PC-Rated Clearance & Side Marker Light



- Compact single diode design fits 3/4" hole.
- PC rated as both clearance and side marker light when mounted at a 45° angle with optical facets in lens running vertically.
- Hardwired 8" leads available either stripped, or with .180 bullets.
- 12 volt and multi-volt (9–32V) versions.
- Includes rubber mounting grommet.

Order No.	Description	Pack	Std Carton
V181A-BT2	<b>KIT</b> amber, .180 bullets & grommet	Viz Pack	6
V181R-BT2	<b>KIT</b> red, .180 bullets & grommet	Viz Pack	6
181KA	<b>KIT</b> amber, stripped leads & grommet	poly pack	6
181KR	<b>KIT</b> red, stripped leads & grommet	poly pack	6
181KA-BT2	<b>KIT</b> amber, .180 bullets & grommet	poly pack	6
181KR-BT2	<b>KIT</b> red, .180 bullets & grommet	poly pack	6
181KA-MV	<b>KIT</b> amber kit, stripped, multi-volt	poly pack	6
181KR-MV	<b>KIT</b> red kit, stripped, multi-volt	poly pack	6
M181A	<b>KIT</b> amber, stripped leads & grommet	mfg. pack	50
M181R	<b>KIT</b> red, stripped leads & grommet	mfg. pack	50
M181A-BT2	<b>KIT</b> amber, .180 bullets & grommet	mfg. pack	50
M181R-BT2	<b>KIT</b> red, .180 bullets & grommet	mfg. pack	50
M181A-MV	<b>KIT</b> amber, stripped leads, multi-volt	mfg. pack	50
M181R-MV	<b>KIT</b> red, stripped leads, multi-volt	mfg. pack	50
M181A-MV-BT2	<b>KIT</b> amber, .180 bullets, multi-volt	mfg. pack	50
M181R-MV-BT2	<b>KIT</b> red, .180 bullets, multi-volt	mfg. pack	50
B177-18	grommet	mfg. pack	100

See pages 180–183 for additional mounting options.

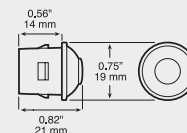



## 186 LumenX® Dot XL™ LED 1 3/8" PC-Rated Clearance & Side Marker Light



- Round 1 3/8" diameter model fits popular 3/4" mounting holes.
- Single-diode LED design with white diode behind colored lens.
- PC-rated, functions as both clearance and side marker light when mounted at a 45° angle.
- Hardwired 8" leads available either stripped, or with .180 bullets.
- 9-16 volt operating range.
- Includes specially designed mounting grommet for installation.

Order No.	Description	Pack	Std Carton
186KA	<b>KIT</b> amber, stripped leads	poly pack	12
186KR	<b>KIT</b> red, stripped leads	poly pack	12
M186A	<b>KIT</b> amber, stripped leads	mfg. pack	50
M186R	<b>KIT</b> red, stripped leads	mfg. pack	50
M186A-BT2	<b>KIT</b> amber, .180 bullets	mfg. pack	50
M186R-BT2	<b>KIT</b> red, .180 bullets	mfg. pack	50
B186-10	surface-mount bracket - flat	mfg. pack	100
B186-13	surface-mount bracket - curved	mfg. pack	100



B186-10 bracket  
(bracket and light sold separately)

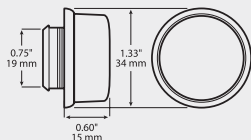

## 286 LumenX® Dot XL™ LED PC-Rated Clearance & Side Marker w/ Aux Function



- Round 1 3/8" diameter model fits popular 3/4" mounting holes.
- Single-diode LED design with white diode behind colored lens.
- PC-rated, functions as both clearance and side marker light when mounted at a 45° angle.
- Hardwired 8" leads available either stripped, or with .180 bullets.
- Features a third wire for auxiliary brake or turn functions.
- 9-16 volt operating range.
- Includes specially designed mounting grommet for installation.

Order No.	Description	Pack	Std Carton
286KA	<b>KIT</b> amber w/ aux function, stripped	poly pack	6
286KR	<b>KIT</b> red w/ aux function, stripped	poly pack	6
286KA-BT3	<b>KIT</b> amber w/ aux func, .180 bullets	poly pack	6
286KR-BT3	<b>KIT</b> red w/ aux function, .180 bullets	poly pack	6
M286A	<b>KIT</b> amber w/ aux function, stripped	mfg. pack	50
M286R	<b>KIT</b> red w/ aux function, stripped	mfg. pack	50
M286A-BT3	<b>KIT</b> amber w/ aux func, .180 bullets	mfg. pack	50
M286R-BT3	<b>KIT</b> red w/ aux function, .180 bullets	mfg. pack	50
B186-10	surface-mount bracket - flat	mfg. pack	100
B186-13	surface-mount bracket - curved	mfg. pack	100

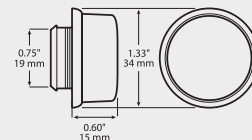

# LED CLEARANCE/MARKER W/ AUX



## 233 LED 2½" PC-Rated Clearance & Side Marker Light w/ Aux Function



- Functions as clearance & side marker light mounted at 45° angle.
- Amber light equipped with 1 diode, red light has 5 diodes.
- Does not require top-mount positioning to meet DOT requirements.
- Features a third wire for auxiliary brake or turn function.
- Integrated receptacle accepts AMP-style sealed connector.
- 9-16 volt operating range.
- 143-18 grommet and compatible plug required for installation.
- Available with amber or red diodes behind clear lens.

Order No.	Description	Pack	Std Carton
M233A	amber, grommet mount	mfg. pack	50
M233R	red, grommet mount	mfg. pack	50
M233FA	amber, flange mount	mfg. pack	50
M233FR	red, flange mount	mfg. pack	50
M233CA	amber w/clear lens, grommet	mfg. pack	50
M233CR	red w/clear lens, grommet	mfg. pack	50
M233FCA	amber w/ clear lens, flange	mfg. pack	50
M233FCR	red w/ clear lens, flange	mfg. pack	50
143-18	grommet	poly pack	24
B143-18	grommet	mfg. pack	100
417-49	plug	poly pack	6
B417-49	plug	mfg. pack	100

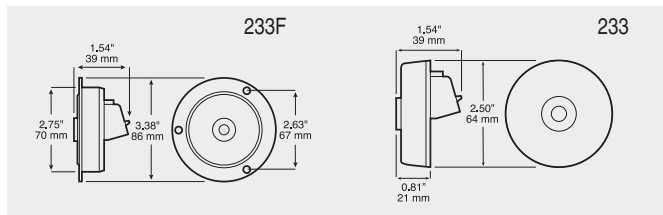

# CLEARANCE/MARKER LIGHTS



## 253 LED Clearance/Side Marker Light w/ Aux Function



- Rectangular LED clearance, side marker and ID light.
- Features a third wire for auxiliary brake or turn functions.
- DOT legal when mounted horizontally with up to a 32° tilt back.
- Hardwired design has stripped leads with ring terminal on ground.
- 9-16 voltage operating range.
- See mounting accessories on pages 175–176 for additional mounting options.

Order No.	Description	Pack	Std Carton
M253A	amber	mfg. pack	50
M253R	red	mfg. pack	50
150-095	surface-mount bracket	poly pack	12
B150-095	surface-mount bracket	mfg. pack	100

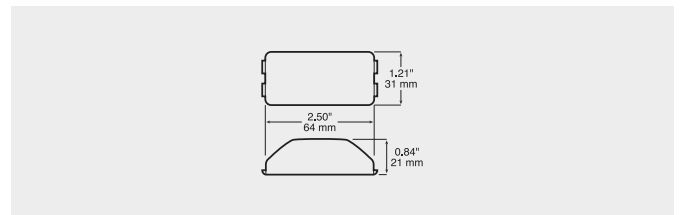

STT  
TURN  
MARKER  
B-U/UTIL  
SPEC  
EMERG  
ECE  
MOUNT  
ELECT  
REFLECT  
ACCY  
MERCH  
TECH

# CLEARANCE/MARKER LIGHTS



## 179 LED Oval Accessory Tunnel Lights™



- Chrome stealth look when off, stunning 3D tunnel effect when on!
- Illuminate and beautify stainless steel air cleaners, headache racks, bumpers, door panels, & running boards.
- For off-road or accessory use; not to replace legally required lighting.
- Mounts on 4" centers using #10 screws
- Reversible leads w/ .180 bullets. Terminals can be removed for hard-wiring connection to vehicle harness.
- Compatible with all 12 volt systems.
- 3-year warranty.

Mirrored "stealth" look when unlit

Order No.	Description	Pack	Std Carton
179A	amber	poly pack	12
179R	red	poly pack	12
M179A	amber	mfg. pack	50
M179R	red	mfg. pack	50

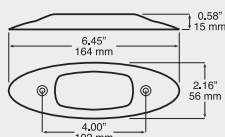

# LED ACCESSORY LIGHTS



## 272/274 LED 2½ or 2" Round Auxiliary Tunnel Lights™



Mirrored "stealth" look when unlit

- Chrome stealth look when off, stunning 3D tunnel effect when on!
- Perfect for air cleaners, stainless skirts, headache racks, side rails, etc.
- For off-road or accessory use; not to replace legally required lighting.
- Mounting grommet required for installation, included in kits.
- Compatible with 2" and 2.5" chrome bezels. See page 192.
- Reversible leads w/ .180 bullets color-coded to indicate lamp color.
- Compatible with all 12 volt systems.
- 3-year warranty.

Order No.	Description	Pack	Std Carton
272KA	<b>KIT</b> amber 2.5" w/ grommet	poly pack	12
274KA	<b>KIT</b> amber 2" w/ grommet	poly pack	12
274KR	<b>KIT</b> red 2" w/ grommet	poly pack	12
M272A	amber 2.5"	mfg. pack	50
M274A	amber 2"	mfg. pack	50
M274R	red 2"	mfg. pack	50
B143-18	2.5" mounting grommet	mfg. pack	100
B146-18	2" mounting grommet	mfg. pack	100

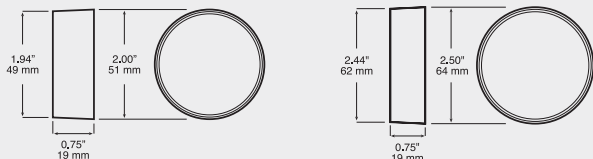

## 176RGB LED 3/4" Multi-Color Accessory Light



- Compact light fits 3/4" hole.
- Common power wire plus 3 separate ground wires permit illumination in seven colors: red, blue, green, cyan, violet, yellow and white.
- Hardwired with four 8" wires.
- Compatible grommet or bracket required for installation. See pages 180-182.
- Check local laws before mounting on exterior of road-legal vehicles.

Order No.	Description	Pack	Std Carton
M176RGB	seven selectable colors	mfg. pack	50
4741B	blue only, 2-wire	mfg. pack	50
B177-18	rubber grommet	mfg. pack	100



**MULTI-COLOR  
LIGHT**

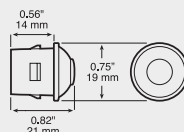

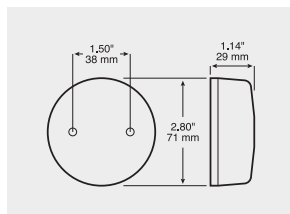

## 102 Surface Mount Clearance & Side Marker Light



- Surface-mount light functions as clearance and side marker.
- Durable base and acrylic lens provides high quality at economical price.
- Grounds through mounting screw with single lead wire.
- Available in amber or red.

Order No.	Description	Pack	Std Carton
V102A	amber	Viz Pack	6
V102R	red	Viz Pack	6
M102A	amber	mfg. pack	100
M102R	red	mfg. pack	100
102-15A	amber lens	poly pack	10
102-15R	red lens	poly pack	10
193 or 194	12 volt replacement bulb		<i>reference only</i>

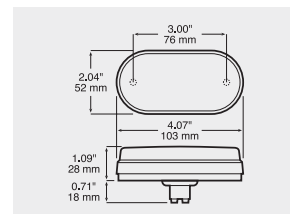

## 106 Combination 2-Bulb Light w/ Reflex



- Two bulbs for increased reliability.
- Molded base and socket absorb shock and vibration.
- Grounds through mounting screw with single lead wire.
- V108-15 contains two lenses per pack.

Order No.	Description	Pack	Std Carton
M106A	amber	mfg. pack	100
M106R	red	mfg. pack	100
V108-15A	amber lens 2-pack	Viz Pack	6
V108-15R	red lens 2-pack	Viz Pack	6
108-15A	amber lens	poly pack	10
108-15R	red lens	poly pack	10
B108-15A	amber lens	bulk pack	100
B108-15R	red lens	bulk pack	100
193 or 194	12 volt replacement bulb		<i>reference only</i>

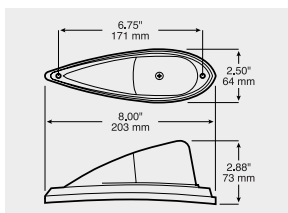

## 109 Cab Marker Light



- Rugged, diecast housing with chrome-plated finish.
- Special base design and neoprene mounting pad allow light to be mounted on both flat or curved surfaces.
- Single-screw convenience for bulb or lens service.
- Includes single lead wire and grounds through mounting screw.
- Available in amber only.

Order No.	Description	Pack	Std Carton
V109A	amber	Viz Pack	6
67	replacement bulb		<i>reference only</i>

STT  
TURN  
MARKER  
B-U/UTIL  
SPEC  
EMERG  
ECE  
MOUNT  
ELECT  
REFLECT  
ACCY  
MERCH  
TECH



## 107 Mini-Lite Clearance/Side Marker



- Amber or red lights functions as clearance, side marker or identification light.
- Blue and green lights are for accessory use only, not for use as legally-required clearance or marker lights.
- Features durable base with external mounting holes.
- Lens snap-locks onto base.
- Running-board light kit contains six lights, mounting hardware, connectors, and easy-to-follow instructions.
- Includes single lead wire and grounds through mounting screw.

Order No.	Description	Pack	Std Carton
V107WA	amber	Viz Pack	3
V107WB	blue	Viz Pack	6
V107WR	red	Viz Pack	3
107WA	amber	poly pack	48
107WR	red	poly pack	48
M107WA	amber	mfg. pack	100
M107WR	red	mfg. pack	100
V107-15A	amber lens	Viz Pack	6
V107-15R	red lens	Viz Pack	6
107-15A	amber lens	poly pack	10
107-15R	red lens	poly pack	10
107-15B	blue lens	poly pack	10
107-15G	green lens	poly pack	10
B107-15A	amber lens	bulk pack	100
B107-15R	red lens	bulk pack	100
193 or 194	12 volt replacement bulb		<i>reference only</i>
464	24 volt replacement bulb		<i>reference only</i>

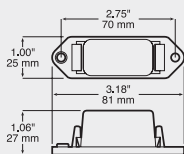

## 108 Combination 1-Bulb Light w/ Reflex



- Molded base with single-bulb socket
- Single lead wire; grounds through mounting screw.
- See pages 251 & 255 for replacement lens photos.
- V108-15A and V108-15R Viz Packs contain two lenses per package.
- Replacement lens compatibility depends on date of manufacture:

MANUFACTURE DATE	AMBER	RED
Through 2011	108-15A	108-15R
2012–2018	108-151A	108-151R
2019–On	V2549-15A	V2549-15R

Order No.	Description	Pack	Std Carton
V108WA	amber	Viz Pack	3
V108WR	red	Viz Pack	3
108WA	amber	poly pack	24
108WR	red	poly pack	24
M108WA	amber	mfg. pack	100
M108WR	red	mfg. pack	100
V2549-15A	amber repl. lens, 2019–on	Viz Pack	10
V2549-15R	red repl. lens, 2019–on	Viz Pack	10
108-151A	amber repl. lens, 2012–2018	poly pack	10
108-151R	red repl. lens, 2012–2018	poly pack	10
B108-151A	amber repl. lens, 2012–2018	bulk pack	100
B108-151R	red repl. lens, 2012–2018	bulk pack	100
V108-15A	amber lens 2-pack, 2011–prior	Viz Pack	6
V108-15R	red lens 2-pack, 2011–prior	Viz Pack	6
108-15A	amber repl. lens, 2011–prior	poly pack	10
108-15R	red repl. lens, 2011–prior	poly pack	10
B108-15A	amber repl. lens, 2011–prior	bulk pack	100
B108-15R	red repl. lens, 2011–prior	bulk pack	100
193 or 194	12 volt replacement bulb		<i>reference only</i>

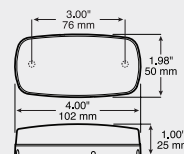



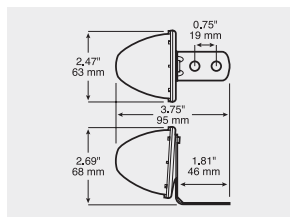
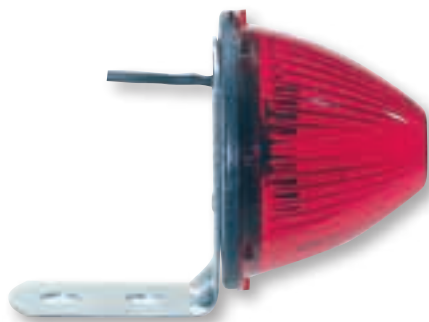

## 110

### PC-Rated Clearance/Side Marker Light



- Has corrosion-resistant molded housing and plated metal bracket.
- Acrylic lens snaps onto housing.
- Includes single lead wire and grounds through mounting screw.
- V110-15 contains two lenses per pack.

Order No.	Description	Pack	Std Carton
V110A	amber	Viz Pack	6
V110R	red	Viz Pack	6
M110A	amber	mfg. pack	100
M110R	red	mfg. pack	100
V110-15A	amber lens 2-pack	Viz Pack	6
V110-15R	red lens 2-pack	Viz Pack	6
110-15A	amber lens	poly pack	10
110-15R	red lens	poly pack	10
193 or 194	12 volt replacement bulb		<i>reference only</i>

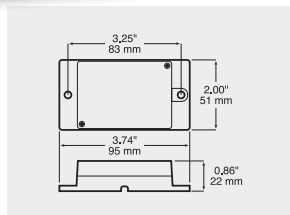
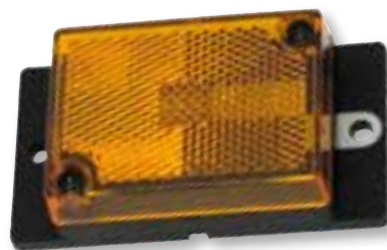

## 112

### Clearance/Side Marker Light w/ Reflex



- Surface mounts on 3.25" centers.
- Single bulb.
- Single lead wire for electrical connection.
- Grounds through mounting hardware.
- 15,000-hour-rated long-life bulb.

Order No.	Description	Pack	Std Carton
V112A	amber	Viz Pack	3
114-15A	amber lens	poly pack	10
193 or 194	12 volt replacement bulb		<i>reference only</i>

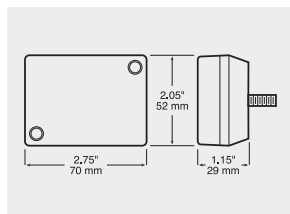

## 114

### PC-Rated Clearance/Side Marker w/ Reflex



- "Quick Lock" port; just push stripped power wire in to connect.
- Grounds through stud, or through additional ground wire port.
- Use as both side marker and clearance light when properly mounted.
- Features 15,000-hour-rated long life bulb.
- See 170 series LED version on page 59.

Order No.	Description	Pack	Std Carton
V114A	amber	Viz Pack	3
V114R	red	Viz Pack	6
M114A	amber	mfg. pack	100
M114R	red	mfg. pack	100
114-15A	amber lens	poly pack	10
114-15R	red lens	poly pack	10
193 or 194	12 volt replacement bulb		<i>reference only</i>

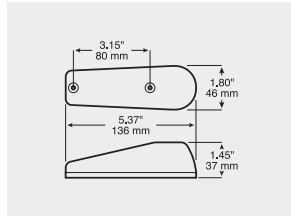

## 116 Clearance/Side Marker Light w/ Reflex



- Surface mount, wedge design popular for use on recreational trailers.
- Single electrical lead; grounds through mounting hardware.
- Mounts on 3 1/8" centers.
- Lens and housing sonic-welded to form a sealed single unit.

Order No.	Description	Pack	Std Carton
M116A	amber	mfg. pack	100

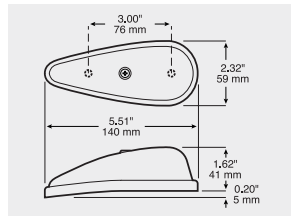

## 118 Cab Marker Light



- Popular style, amber cab marker light interchanges with competitive models.
- Base constructed of molded, corrosion-resistant ABS.
- Grounds through mounting hardware.
- Kit pack includes five lights, wire harness and mounting hardware.

Order No.	Description	Pack	Std Carton
V118A	amber	Viz Pack	6
V118KA	<b>KIT</b> 5 light amber kit	Viz Pack	6
M118A	amber	mfg. pack	200
118-15A	amber lens	poly pack	10
67	replacement bulb		<i>reference only</i>

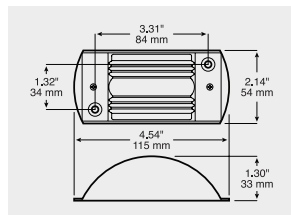

## 119 PC-Rated Clearance/Side Marker Light



- Functions as combination side marker and clearance light when properly mounted.
- Acrylic lens guarded by 14-gauge, bright-plated steel housing.
- Can be spot-welded to side rails, truck bed rails, etc.
- Flat-back design mounts without disassembly.
- Includes single lead wire and grounds through mounting screw.
- Blue and green for accessory use only.

Order No.	Description	Pack	Std Carton
119A	amber	poly pack	24
119R	red	poly pack	24
M119A	amber	mfg. pack	48
M119R	red	mfg. pack	48
119-15A	amber lens	poly pack	10
119-15R	red lens	poly pack	10
168	replacement bulb		<i>reference only</i>

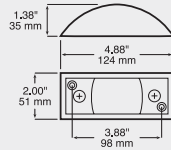

## 122 Vanguard II Armored PC-Rated Clearance & Side Marker Light



- Surface-mount design functions as side marker or clearance light.
- Can also be used as combination marker and clearance light when properly mounted.
- Impact-resistant, molded housing resists rust and corrosion
- Includes mounting gasket.
- Includes single lead wire; grounds through mounting screws.

Order No.	Description	Pack	Std Carton
M122A	amber	mfg. pack	48
M122R	red	mfg. pack	48
124-15A	amber lens	poly pack	10
124-15R	red lens	poly pack	10
193 or 194	12 volt replacement bulb		

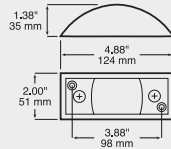

## 122X Vanguard II Armored Chrome PC-Rated Clearance & Side Marker Light



- Deluxe, chrome-plated version of 122 series clearance and side marker light; same function and features as 122 series.
- Includes single lead wire; grounds through mounting screws.
- Brilliant, durable, copper-nickle, chrome-plated finish.

Order No.	Description	Pack	Std Carton
V122XA	amber	Viz Pack	6
V122XR	red	Viz Pack	6
M122XA	amber	mfg. pack	48
M122XR	red	mfg. pack	48
124-15A	amber lens	poly pack	10
124-15R	red lens	poly pack	10
193 or 194	12 volt replacement bulb		<i>reference only</i>

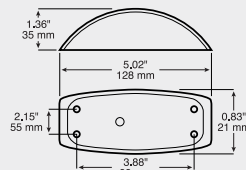

## 123 Cast Aluminum PC-Rated Clearance & Side Marker Light



- Flat back light functions as clearance or side marker light.
- When properly mounted, can also be used as combination side marker and clearance light.
- Flat back design eliminates need for socket hole.
- Features 15,000-hour-rated long life bulb and single lead wire.
- Grounds through mounting screw.

Order No.	Description	Pack	Std Carton
123A	amber	poly pack	24
123R	red	poly pack	24
124-15A	amber lens	poly pack	10
124-15R	red lens	poly pack	10
193 or 194	12 volt replacement bulb		<i>reference only</i>

## 124 Vanguard PC-Rated Clearance & Side Marker Light

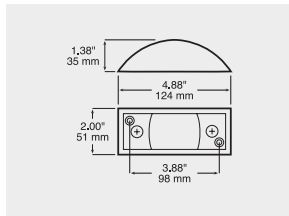

- Features durable diecast housing, zinc screws and snap-in bushing.
- Pass-through mounting holes for installation without disassembly.
- Flat-back design eliminates need for socket hole.
- Equipped with 15,000-hour-rated long-life bulb.
- Includes single lead wire.
- Grounds through mounting screws.

Order No.	Description	Pack	Std Carton
124A	amber	poly pack	24
124R	red	poly pack	24
M124A	amber	mfg. pack	48
M124R	red	mfg. pack	48
124-15A	amber lens	poly pack	10
124-15R	red lens	poly pack	10
193 or 194	12 volt replacement bulb		<i>reference only</i>

## 125 Clearance/Side Marker Light w/ Reflex

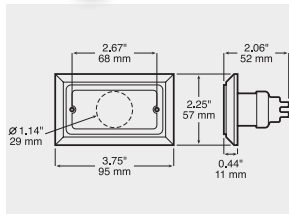

- Lightweight, chrome plated ABS housing
- Mounts on 2-11/16" centers; uses lens screws as mounting screws.
- Twist-in socket assembly contains both lead wire and ground wire for mounting on all surfaces.
- Requires 1-1/4" socket mounting hole for installation.

Order No.	Description	Pack	Std Carton
M125A	amber	mfg. pack	96
M125R	red	mfg. pack	96
125-15A	amber lens	poly pack	10
125-15R	red lens	poly pack	10
193 or 194	12 volt replacement bulb		<i>reference only</i>

## 126 Clearance/Side Marker Light

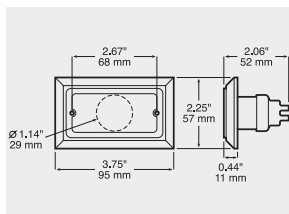

- Lightweight, chrome plated ABS housing
- Mounts on 2-11/16" centers; uses lens screws as mounting screws.
- Twist-in socket assembly contains both lead wire and ground wire for mounting on all surfaces.
- Requires 1-1/4" socket mounting hole for installation.

Order No.	Description	Pack	Std Carton
V126A	amber	Viz Pack	6
V126R	red	Viz Pack	6
M126A	amber	mfg. pack	96
M126R	red	mfg. pack	96
126-25A	amber lens	poly pack	10
126-25R	red lens	poly pack	10
193 or 194	12 volt replacement bulb		<i>reference only</i>

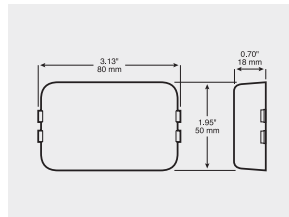

## 127

### Clearance/Side Marker Light



- OE replacement light for Knapheide truck bodies.
- Features sealed lens and housing and 15,000-hour-rated, 12-volt bulb.
- Mounts flush to vehicle with rubber grommet.
- Grommet and 2-wire plug required to complete installation.
- Viz-Pack kits include light, plug and white grommet.

Order No.	Description	Pack	Std Carton
V127KA	<b>KIT</b> amber kit	Viz Pack	6
V127KR	<b>KIT</b> red kit	Viz Pack	6
127A	amber	poly pack	24
127R	red	poly pack	24
M127A	amber	mfg. pack	100
M127R	red	mfg. pack	100
127-18	grommet, black	poly pack	24
B127-18	grommet, black	mfg. pack	100
142-49	plug	poly pack	12
B142-49	plug	mfg. pack	100

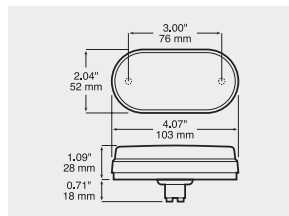

## 128

### Clearance/Side Marker Light w/ Reflex



- Mounts on 3" centers.
- Features twist-in socket assembly with both lead and ground wires for mounting to all surfaces.
- V108-15 contains two lenses per pack.

Order No.	Description	Pack	Std Carton
V128A	amber	Viz Pack	6
V128R	red	Viz Pack	6
V108-15A	amber lens	Viz Pack	6
V108-15R	red lens	Viz Pack	6
108-15A	amber lens	poly pack	10
108-15R	red lens	poly pack	10
193 or 194	12 volt replacement bulb		<i>reference only</i>

## 132

### Clearance/Side Marker Light w/ Reflex



- Rectangular, one-bulb design.
- Surface mounts on 3-3/8" centers with mounting gasket included.
- Twist-in socket assembly contains both lead wire and ground wire for mounting on all surfaces.

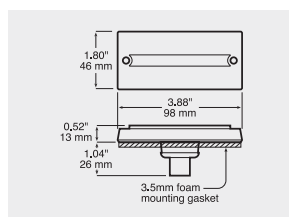
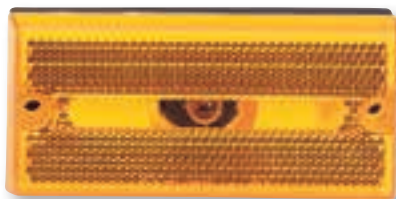

Order No.	Description	Pack	Std Carton
V132A	amber	Viz Pack	6
V132R	red	Viz Pack	6
M132A	amber	mfg. pack	100
M132R	red	mfg. pack	100
193 or 194	12 volt replacement bulb		<i>reference only</i>



### 130 Hard-Hat Clearance/Side Marker Light w/ Reflex



- Original, hard-hat style clearance or side marker light with built-in reflector optics; eliminates need for separate reflector.
- Contains two bulbs for maximum light output.
- Utilizes one lead wire and grounds through mounting screws.
- Compatible with 106-09 chrome accessory guard. See page 171.

Order No.	Description	Pack	Std Carton
130A	amber	poly pack	24
130R	red	poly pack	24
M130A	amber	mfg. pack	100
M130R	red	mfg. pack	100
130-25A	amber lens	poly pack	10
130-25R	red lens	poly pack	10
V106-09	chrome guard	Viz Pack	6
B106-09	chrome guard	mfg. pack	60
193 or 194	12 volt replacement bulb		<i>reference only</i>

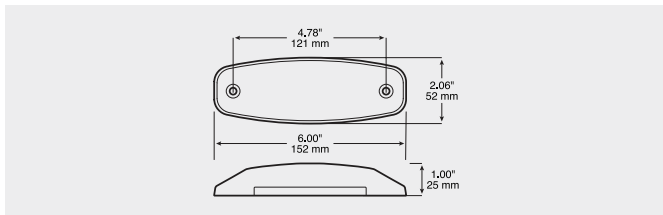

### 136 Thin-Line Clearance/Side Marker Light



- Surface mounting.
- High-impact base and scratch-resistant acrylic lens.
- May be mounted horizontally or vertically.
- Includes single lead wire and grounds through mounting screw.

Order No.	Description	Pack	Std Carton
V136A	amber	Viz Pack	6
V136R	red	Viz Pack	6
136A	amber	poly pack	24
136R	red	poly pack	24
M136A	amber	mfg. pack	100
M136R	red	mfg. pack	100
136-15A	amber lens	poly pack	10
136-15R	red lens	poly pack	10
193 or 194	12 volt replacement bulb		<i>reference only</i>

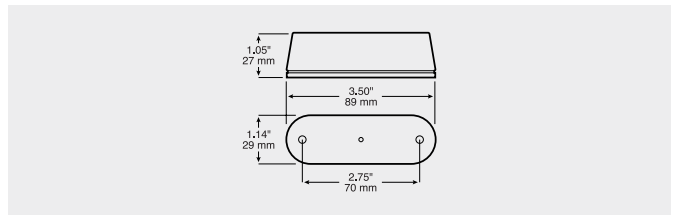

### 137 Clearance/Side Marker Light



- Direct replacement for OE lights on older Peterbilt trucks.
- Two-wire design includes .180 bullet and #10 ring terminal.
- Includes stainless-steel, self-tapping mounting screws.
- Mounts on 3 15/16" centers.

Order No.	Description	Pack	Std Carton
M137A	amber	mfg. pack	50
M137R	red	mfg. pack	50
193 or 194	12 volt replacement bulb		<i>reference only</i>

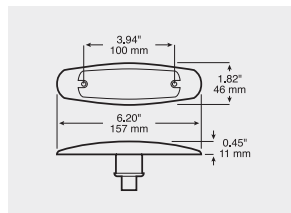



## 135 PC-Rated Clearance & Side Marker Light



- Two bulb design.
- Acrylic lens snaps onto housing.
- Surface mounts on 3" centers.
- Single wire connection, grounds through mounting hardware.
- 15,000-hour-rated long-life bulb.
- V134-15 contains two lenses per pack.
- See 35 LED version on page 54.

Order No.	Description	Pack	Std Carton
V135A	amber	Viz Pack	3
V135R	red	Viz Pack	3
135A	amber	poly pack	24
135R	red	poly pack	24
M135A	amber	mfg. pack	100
M135R	red	mfg. pack	100
V134-15A	amber lens	Viz Pack	6
V134-15R	red lens	Viz Pack	6
134-15A	amber lens	poly pack	10
134-15R	red lens	poly pack	10
B134-15A	amber lens	bulk pack	100
B134-15R	red lens	bulk pack	100
193 or 194	12 volt replacement bulb		<i>reference only</i>

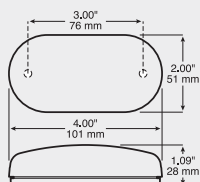

## 138 PC-Rated Clearance & Side Marker Light



- "Double bulls-eye" twin bulb design.
- Acrylic lens snaps onto housing.
- Surface mounts on 3" centers
- Single 4.5" wire connection, grounds through mounting hardware.
- Features two 15,000-hour-rated long-life bulbs.
- Compatible with 106-09 chrome accessory guard. See page 171.
- Blue, clear and green lenses available for accessory use only.
- V138-15 contains two lenses per pack.
- See 38 LED version on page 54.

Order No.	Description	Pack	Std Carton
V138A	amber	Viz Pack	3
V138R	red	Viz Pack	3
138A	amber	poly pack	24
138R	red	poly pack	24
M138A	amber	mfg. pack	100
M138C	clear	mfg. pack	100
M138G	green	mfg. pack	100
M138R	red	mfg. pack	100
V138-15A	amber lens	Viz Pack	6
V138-15R	red lens	Viz Pack	6
138-15A	amber lens	poly pack	10
138-15R	red lens	poly pack	10
B138-15A	amber lens	bulk pack	100
B138-15B	blue lens	bulk pack	100
B138-15C	clear lens	bulk pack	100
B138-15G	green lens	bulk pack	100
B138-15R	red lens	bulk pack	100
V106-09	chrome guard	Viz Pack	6
B106-09	chrome guard	mfg. pack	60
193 or 194	12 volt replacement bulb		<i>reference only</i>
464	24 volt replacement bulb		<i>reference only</i>

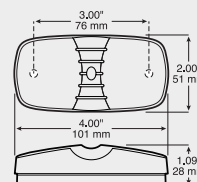



B162-093 retention clip

## 140 Incandescent 2" Clearance/Side Marker Light w/ Reflex



- 2" round light with 15,000-hour long-life incandescent bulb.
- Built-in reflex, eliminating need for separate reflector.
- Fits metric size mounting holes.
- Welded terminals, no solder.
- Accepts industry standard 2-wire plug.
- 9-16 voltage operating range.
- Protective gasket included.
- See 190 series LED version lights on page 63.

Order No.	Description	Pack	Std Carton
M140FA	amber	mfg. pack	100
M140FR	red	mfg. pack	100
140 24	replacement gasket	mfg. pack	1
142-49	plug	poly pack	12
B142-49	plug	mfg. pack	100
B162-093	stainless steel retaining clip	mfg. pack	100

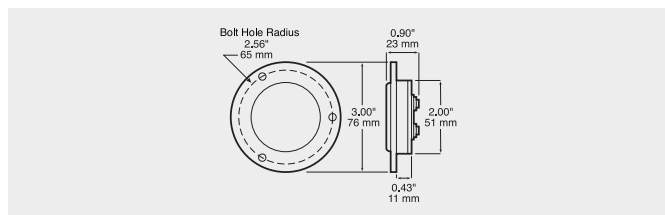

142ABS

## 142 2½" PC-Rated Clearance/Side Marker Light



- Lens is welded to housing to form single unit.
- Requires mounting grommet and 2-wire plug for installation.
- Features 15,000-hour-rated long-life bulb.
- Kits include 142 light, 142-18 grommet and 142-49 plug.
- ABS warning version avail., or see 2954 accessory ABS label on page 194.
- See pages 64–65 for LED versions.
- See mounting accessory section for additional mounting options.

Order No.	Description	Pack	Std Carton
V142A	amber	Viz Pack	6
V142R	red	Viz Pack	6
V142KA	<b>KIT</b> amber kit	Viz Pack	6
V142KR	<b>KIT</b> red kit	Viz Pack	6
142A	amber	poly pack	24
142R	red	poly pack	24
142KA	<b>KIT</b> amber kit	poly pack	12
142KR	<b>KIT</b> red kit	poly pack	12
M142A	amber	mfg. pack	100
M142R	red	mfg. pack	100
M142ABS	amber w/ ABS label	mfg. pack	100
142-18	grommet	poly pack	24
B142-18	grommet	mfg. pack	100
142-49	plug	poly pack	12
B142-49	plug	mfg. pack	100

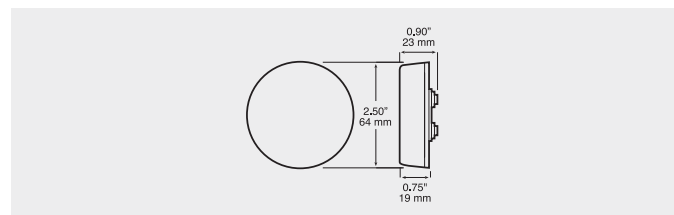





143FR

## 143

### 2½" Clearance/Side Marker Light w/ Reflex



- Functions as side marker or clearance light.
- 143 series features built-in reflex optics, eliminating the need for a separate reflector.
- 143F has reflex-enabled flange integral with lens.
- 143 light comes without flange for use with rubber grommet.
- Accepts industry standard 2-wire plug.
- Features 15,000-hour-rated long life bulb.
- See pages 62–63 for LED versions.
- See mounting accessory section for additional mounting options.

Order No.	Description	Pack	Std Carton
V143A	amber	Viz Pack	6
V143R	red	Viz Pack	6
143A	amber	poly pack	24
143R	red	poly pack	24
M143A	amber	mfg. pack	100
M143R	red	mfg. pack	100
M143FA	amber, flange mount	mfg. pack	100
M143FR	red, flange mount	mfg. pack	100
142-18	grommet	poly pack	24
B142-18	grommet	mfg. pack	100
142-49	plug	poly pack	12
B142-49	plug	mfg. pack	100

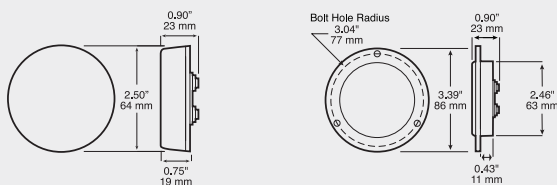

146ABS

## 146

### 2" PC-Rated Clearance/Side Marker Light



- Functions as side marker or clearance light.
- May be used as combination side marker and clearance light when mounted at a 45° angle.
- Features sealed lens and housing; 146F and 146S lights are sonic welded to flange to form single unit.
- 146 light comes without flange for use with rubber grommet.
- Requires 2-wire plug to complete installation.
- Features 15,000-hour-rated long life bulb.
- Kit includes 146 light, 146-18 grommet and 142-49 plug.
- ABS warning version avail., or see 2954 accessory ABS label on page 194.
- See page 69 for LED versions.
- See mounting accessory section for additional mounting options.

Order No.	Description	Pack	Std Carton
V146A	amber	Viz Pack	6
V146R	red	Viz Pack	6
V146KA	<b>KIT</b> amber kit	Viz Pack	6
V146KR	<b>KIT</b> red kit	Viz Pack	6
146A	amber	poly pack	24
146R	red	poly pack	24
M146A	amber	mfg. pack	100
M146R	red	mfg. pack	100
M146KA	<b>KIT</b> amber kit	mfg. pack	100
M146KR	<b>KIT</b> red kit	mfg. pack	100
M146SA	amber, surface mount	mfg. pack	100
M146SR	red, surface mount	mfg. pack	100
M146ABS	amber w/ ABS mark	mfg. pack	100
146-18	grommet	poly pack	24
B146-18	grommet	mfg. pack	100
142-49	plug	poly pack	12
B142-49	plug	mfg. pack	100

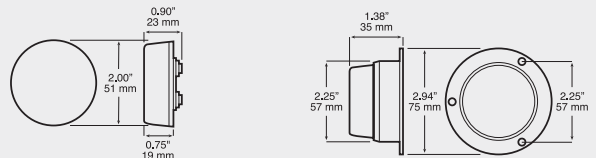

STT  
TURN  
MARKER  
B-U/UTIL  
SPEC  
EMERG  
ECE  
MOUNT  
ELECT  
REFLECT  
ACCY  
MERCH  
TECH

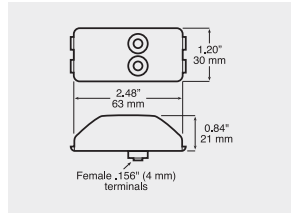
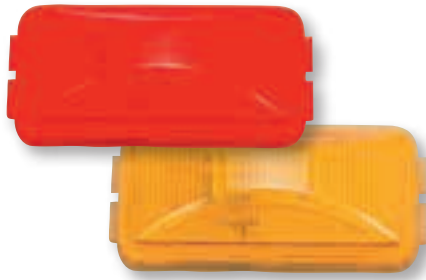

150-09



150-10

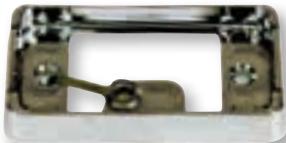

150-102



150-18



150-181

## 150

### PC-Rated Clearance/Side Marker Light



- Functions as side marker or clearance light and may be used as a combination clearance and side marker when properly mounted.
- Lens is welded to housing to form single unit.
- Features 15,000-hour-rated, long-life bulb and female terminals.
- Mounting bracket and electrical connector required to complete installation; see mounting and electrical accessories for details.
- Viz Pack kits include light, 150-102 bracket, lead wire and screws.
- 2636 kit includes light, 150-18 grommet, and 142-49 plug.
- See 203 series LED version on page 70.

Order No.	Description	Pack	Std Carton
V150A	amber	Viz Pack	6
V150R	red	Viz Pack	6
V150KA	<b>KIT</b> amber kit	Viz Pack	6
V150KR	<b>KIT</b> red kit	Viz Pack	6
150A	amber	poly pack	24
150R	red	poly pack	24
M150A	amber	mfg. pack	100
M150R	red	mfg. pack	100
2636A	<b>KIT</b> amber kit	mfg. pack	100
2636R	<b>KIT</b> red kit	mfg. pack	100
150-092	<b>KIT</b> chassis/black kit	poly pack	12
150-102	<b>KIT</b> chassis/chrome kit	poly pack	12
B150-12	chassis/chrome bracket	mfg. pack	100
B150-491	18" molded lead	mfg. pack	100
150-09	gray bracket	poly pack	12
150-091	white bracket	poly pack	12
150-10	chrome bracket	poly pack	12
150-13	black bracket	poly pack	12
B150-18	black grommet	mfg. pack	100
B150-181	black grommet	mfg. pack	100
142-49	6" 2-wire plug	poly pack	12
B142-49	6" 2-wire plug	mfg. pack	100
B142-50	19" 2-wire plug	mfg. pack	100
B142-51	12" 2-wire plug	mfg. pack	100

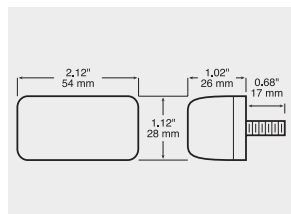
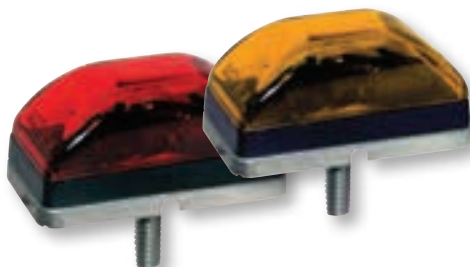

## 151

### Clearance/Side Marker Light



- Functions as side marker or clearance light.
- Lens is welded to housing to form single unit.
- Mounting stud serves as ground when mounted to metallic surface.
- Comes with a single 24" lead wire.
- Available in amber or red.
- See 191 Series LED version on page 70.

Order No.	Description	Pack	Std Carton
151A	amber	poly pack	24
151R	red	poly pack	24
M151A	amber	mfg. pack	100
M151R	red	mfg. pack	100

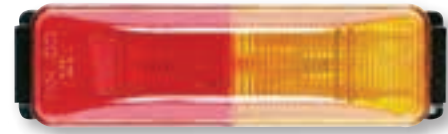
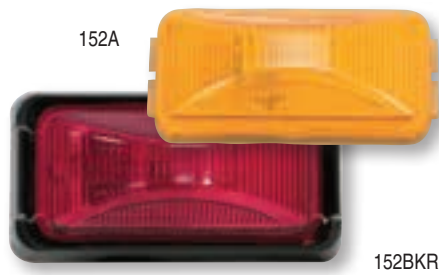

## 152 PC-Rated Clearance/Side Marker Light



- Functions as side marker or clearance light.
- When mounted at a 45° angle, light may be used as combination clearance and side marker light.
- Lens is welded to housing to form single unit.
- Mounting grommet and electrical connector required.
- Kits include 152 light, single 17" lead wire, and mounting bracket with stud that serves as ground when mounted to metallic surface.
- 152 series has male pins.
- Features 15,000-hour-rated, long-life bulb.
- See mounting accessories for additional mounting options.
- Available in amber or red.

Order No.	Description	Pack	Std Carton
152A	amber	poly pack	24
152R	red	poly pack	24
M152A	amber	mfg. pack	100
M152R	red	mfg. pack	100
M152BKA	<b>KIT</b> amber/black kit	mfg. pack	100
M152BKR	<b>KIT</b> red/black kit	mfg. pack	100
B150-18	black grommet	mfg. pack	100
152-49	replacement lead wire	poly pack	12
B153-49	2-way plug	mfg. pack	100

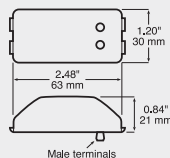

## 154A-R Clearance/Side Marker Light



- Functions as both amber front clearance light and red rear clearance light for over 80" applications.
- Mounts on top or side of most fenders to mark widest point on trailer; ideal for boat, cargo or horse trailers.
- Mounting bracket and electrical connector are required to complete installation; 154 series has male pins.
- Mounting screw serves as ground when mounted to metallic surface with single lead wire for electrical connection.
- Features two 15,000-hour-rated, long-life bulbs.
- See 161 LED version on page 57.
- Utilizes same mounting hardware as standard 154 series; see mounting accessories section for additional mounting options.

Order No.	Description	Pack	Std Carton
154A-R	amber/red	poly pack	24
M154A-R	amber/red	mfg. pack	100
154-09K	<b>KIT</b> gray bracket kit	poly pack	12
B154-09	gray bracket	mfg. pack	100
154-10K	<b>KIT</b> chrome bracket kit	poly pack	12
B154-10	chrome bracket	mfg. pack	100
B154-11	black bracket	mfg. pack	100
154-11K	<b>KIT</b> black bracket kit	poly pack	12
B154-11K	<b>KIT</b> black bracket kit	mfg. pack	100
B154-11K-BT1	<b>KIT</b> black bracket kit, .180 bullet term	mfg. pack	100
153-49	plug	poly pack	12
B153-49	plug	mfg. pack	100

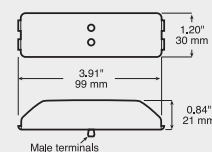

STT

TURN

MARKER

B-U/UTIL

SPEC

EMERG

ECE

MOUNT

ELECT

REFLECT

ACCY

MERCH

TECH

## 154

### PC-Rated Clearance/Side Marker Light



154-09



153-49



154-09K



154-10K



154-11K

- Functions as side marker or clearance light.
- When mounted at a 45° angle, light may be used as combination clearance and side marker light.
- Lens is welded to housing to form single unit.
- Mounting bracket and electrical connector required.
- Mounting screw serves as ground when mounted to metallic surface with single lead wire for electrical connection.
- Features two 15,000-hour-rated, long-life bulbs.
- Kits includes 154 light and gray mounting bracket with lead wire molded into terminal pad and mounting screws.
- 154KA & 154KR kits include light and black mounting bracket with lead wire molded into terminal pad.
- See mounting accessories section for additional mounting options.
- See 161 LED versions on page 57.

Order No.	Description	Pack	Std Carton
V154A	amber	Viz Pack	6
V154R	red	Viz Pack	6
154A	amber	poly pack	24
154R	red	poly pack	24
154KA	<b>KIT</b> amber/gray kit	poly pack	24
154KR	<b>KIT</b> red/gray kit	poly pack	24
M154A	amber	mfg. pack	100
M154R	red	mfg. pack	100
M154KA	<b>KIT</b> amber kit	mfg. pack	100
M154KR	<b>KIT</b> red kit	mfg. pack	100
154-09K	<b>KIT</b> gray bracket kit	poly pack	12
B154-09	gray bracket	mfg. pack	100
154-10K	<b>KIT</b> chrome bracket kit	poly pack	12
B154-10	chrome bracket	mfg. pack	100
B154-11	black bracket	mfg. pack	100
154-11K	<b>KIT</b> black bracket kit	poly pack	12
B154-11K	<b>KIT</b> black bracket kit	mfg. pack	100
B154-11K-BT1	<b>KIT</b> black bracket kit, .180 bullet term	mfg. pack	100
153-49	plug	poly pack	12
B153-49	plug	mfg. pack	100

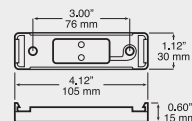
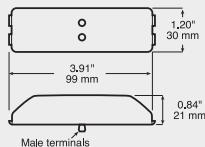



160-49

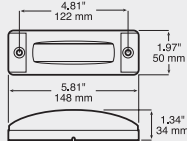

## 155 Sealed PC-Rated Hard Hat II Clearance/Side Marker Light



- May be used as combination side marker and clearance light when properly mounted at a 45° angle.
- Features internal brass contacts for extended service.
- Fitted with two 15,000-hour-rated, long-life bulbs.
- High impact lens is welded to housing to form a single unit.
- 160-49 or 160-491 plug required for installation.
- 155A/R poly pack contains a 160-49 style plug.

Order No.	Description	Pack	Std Carton
155A	amber, sealed	poly pack	24
155R	red, sealed	poly pack	24
M155A	amber, sealed	mfg. pack	50
M155R	red, sealed	mfg. pack	50
160-49	plug	poly pack	12
B160-49	plug	mfg. pack	100

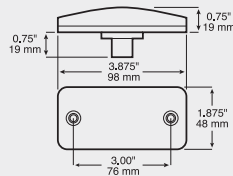

## 2548 Clearance/Side Marker Light



- Popular for RV applications.
- Lens and base welded to form single sealed unit.
- Includes .175"-thick closed cell cushion for mounting.
- Twist-out bulb socket for easy bulb replacement.
- Two-wire electrical connection.

Order No.	Description	Pack	Std Carton
V2548A	amber	Viz Pack	10
V2548R	red	Viz Pack	10
M2548A	amber	mfg. pack	100
M2548R	red	mfg. pack	100
193 or 194	12 volt replacement bulb		<i>reference only</i>

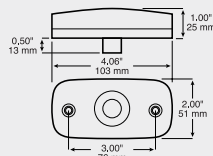

## 2549 Clearance/Side Marker Light



- Popular for RV applications.
- Snap-off lens and twist-out bulb socket provide easy bulb access from outside vehicle or from behind mounting panel.
- Two-wire electrical connection.

Order No.	Description	Pack	Std Carton
V2549A	amber	Viz Pack	10
V2549R	red	Viz Pack	10
V2549-15A	amber replacement lens	Viz Pack	10
V2549-15R	red replacement lens	Viz Pack	10
193 or 194	12 volt replacement bulb		<i>reference only</i>



186-3R shown



177-3R features 3/4" lights

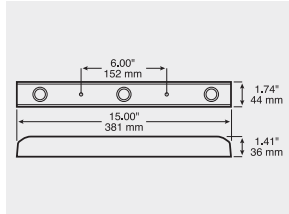

## 177 / 186 LED Identification Light Bar



- Three individual single diode LED lights pre-mounted in one-piece housing.
- 177-3R features 3/4" diameter Dot Lights™.
- 186-3R has three, 1-3/8" diameter, single diode LumenX® Dot XL™ lights.
- Housing made of rugged, corrosion-resistant polymer.
- 9-16 volt operating range.
- Individual lights have hardwired leads terminated with .180 bullets.
- All leads are plugged into pre-installed gang harness for ease of installation.

Order No.	Description	Pack	Std Carton
177-3R	red, 0.75" dia. lights	poly pack	6
186-3R	red, 1 3/8" dia. lights	poly pack	6
M177-3R	red, 0.75" dia. lights	mfg. pack	50
M186-3R	red, 1 3/8" dia. lights	mfg. pack	50

## 169 LED Identification Light Bar



- One-piece housing sealed with epoxy eliminates weld joints.
- Operates from 9-16 volts.
- Features 2-wire, hardwired design.
- Includes mounting gasket.
- Standard version includes blunt-cut hot wires and #10 ring terminal on ground.
- Also available with .180 bullets on hot wires.

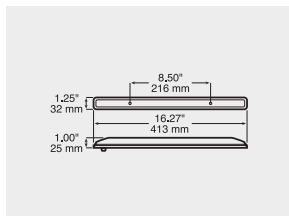

Order No.	Description	Pack	Std Carton
V169-3R	red	Viz Pack	3
169-3R	red	poly pack	24
M169-3A	amber	mfg. pack	100
M169-3R	red	mfg. pack	100
M169-3ABT1	amber w/ .180 bullet & ring term	mfg. pack	100
M169-3RBT1	red w/ .180 bullet & ring term	mfg. pack	100
M169-3RBT2	red w/ two .180 bullets	mfg. pack	100

## 191-3 LED Identification Light Bar



- Sealed LED Identification bar for over-80" applications
- Stainless steel bar is corrosion-resistant with three sealed LED lights
- Pre-wired with single 60" hardwired lead wire
- Mounts on 8.5" centers.

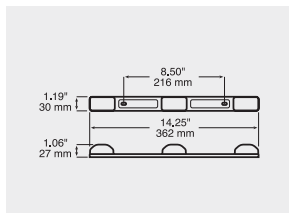

Order No.	Description	Pack	Std Carton
V191-3RL	red	Viz Pack	6
M191-3RL	red	mfg. pack	50

# INCANDESCENT ID BARS

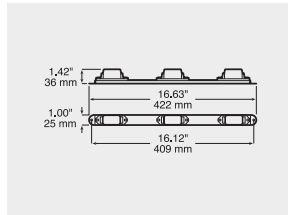

## 107-3 Mini Light Bar



- Economical identification bar light for over 80" applications.
- 107-3 corrosion-resistant bar is powder-coated white with three 107 lights attached.
- Mounts on 16-1/8" centers and grounds through mounting hardware.

Order No.	Description	Pack	Std Carton
V107-3R	red	Viz Pack	3
107-3R	red	poly pack	24
M107-3A	amber	mfg. pack	48
M107-3R	red	mfg. pack	48
107-15A	amber lens	poly pack	10
107-15R	red lens	poly pack	10
B107-15A	amber lens	mfg. pack	100
B107-15R	red lens	mfg. pack	100
193 or 194	12 volt replacement bulb	<i>reference only</i>	

# CLEARANCE/MARKER LIGHTS

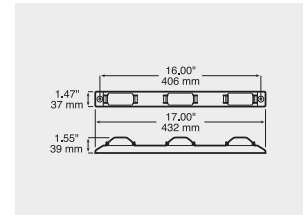

## 150-3 Sealed Submersible Light Bar



- Submersible identification bar light for over 80" applications.
- Black polycarbonate bar is corrosion-proof with three 150 sealed lights attached.
- 150 lights snap on/off for easy service.
- Mounts on 16" centers.
- 0.20 " mounting holes accept #10 screws.
- Includes three-plug harness with two lead wires.
- All versions have 6" ground wire w/ ring terminal and 50" hot wire.
- Field upgradable to LEDs – bar also accepts 203 series on page 70.

Order No.	Description	Pack	Std Carton
150-3R	red	poly pack	6
M150-3R	red	mfg. pack	48
150R	replacement light	poly pack	24
150-49	replac. harness w/ 8" hot lead	poly pack	10

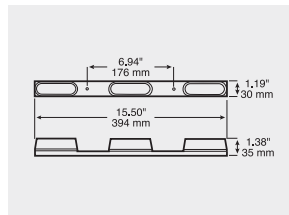

## 136-3 Thin-Line Light Bar

- Identification bar light for over 80" applications.
- Corrosion resistant bar is 24-gauge steel with black enamel finish and three 136 oval lights attached.
- Mounts on 6-15/16" centers.
- Includes single lead wire and grounds through mounting hardware.

Order No.	Description	Pack	Std Carton
136-3R	red	poly pack	24
136-15A	amber lens	poly pack	10
136-15R	red lens	poly pack	10
193 or 194	12 volt replacement bulb	<i>reference only</i>	

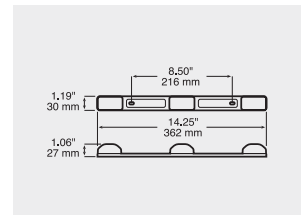

## 151-3 Sealed Submersible Light Bar



- Submersible identification bar light for over 80" applications.
- Stainless steel bar is corrosion-resistant with three sealed lights.
- Pre-wired with 60" lead wire.
- Grounds through mounting hardware.
- Mounts on 8 1/2" centers.
- See 191-3R LED version at left.

Order No.	Description	Pack	Std Carton
V151-3RL	red	Viz Pack	6
M151-3RL	red	mfg. pack	48



## 817-7/818-7 LumenX® LED 4" Round Back-Up Light



- Advanced optics fully illuminate lens.
- A single light meets FMVSS 108 requirements when properly mounted.
- AMP-compatible connector integrated into housing.
- 818-7 has flange integrated into the housing.
- 817-7 has skirted weld joint for added protection against moisture.
- 9–16 volt operating range.
- Regulated design provides voltage protection and consistent light output over a wide voltage range.
- Does not require "Top" positioning to meet FMVSS 108 standard.
- 817 kit includes light, grommet and 817-48 plug.
- 818 kit includes light and 817-48 plug.

Order No.	Description	Pack	Std Carton
817C-7	grommet mount	poly pack	6
818C-7	flange mount	poly pack	6
817KC-7	<b>KIT</b> grommet mount kit	poly pack	6
818KC-7	<b>KIT</b> flange mount kit	poly pack	6
M817C-7	grommet mount	mfg. pack	50
M818C-7	flange mount	mfg. pack	50
426-18	grommet	poly pack	12
B426-18	grommet	mfg. pack	100
417-48	hardshell plug	poly pack	6
B417-48	hardshell plug	mfg. pack	100
817-48	molded plug	poly pack	12
B817-48	molded plug	mfg. pack	100

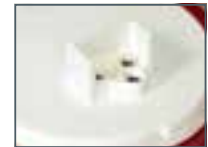
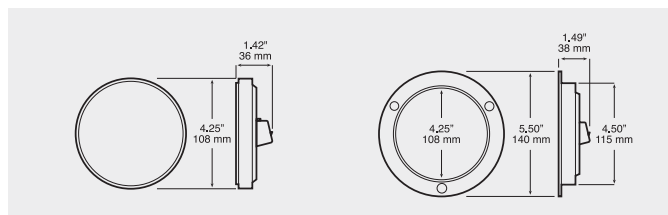

## 824-7/826-7 LumenX® LED 4" Round Back-Up Light



- Advanced optics fully illuminate lens.
- A single light meets FMVSS 108 requirements when properly mounted.
- Industry-standard PL3 socket integrated into housing.
- 824-7 has flange integrated into the housing.
- 826-7 has skirted weld joint for added protection against moisture.
- 9–16 volt operating range.
- Regulated design provides voltage protection and consistent light output over a wide voltage range.
- Does not require "Top" positioning to meet FMVSS 108 standard.
- 826 kit includes light, grommet and 431-49 plug.
- 824 kit includes light and 431-49 plug.

Order No.	Description	Pack	Std Carton
V826KC-7	<b>KIT</b> grommet mount kit	Viz Pack	6
V824KC-7	<b>KIT</b> flange mount kit	Viz Pack	6
826C-7	grommet mount	poly pack	6
824C-7	flange mount	poly pack	6
826KC-7	<b>KIT</b> grommet mount	poly pack	6
824KC-7	<b>KIT</b> flange mount	poly pack	6
M826C-7	grommet mount	mfg. pack	50
M824C-7	flange mount	mfg. pack	50
426-18	grommet	poly pack	12
B426-18	grommet	mfg. pack	100
431-49	plug	poly pack	12
B431-49	plug	mfg. pack	100

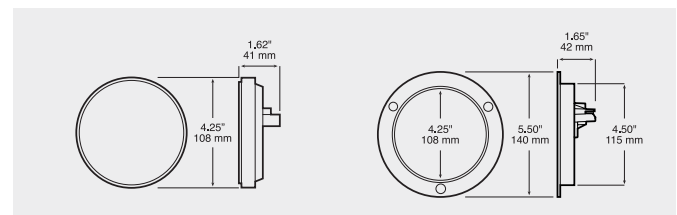



# LED BACK-UP LIGHTS



## 817-9/818-9 LumenX® LED 4" Round Back-Up Light



- Advanced optics fully illuminate lens.
- A single light meets FMVSS 108 requirements when properly mounted.
- AMP-compatible connector integrated into housing.
- 818-9 has flange integrated into the housing.
- 817-9 has skirted weld joint for added protection against moisture
- 9-32 volt operating range is compatible with 12V and 24V vehicles.
- Regulated design provides voltage protection and consistent light output over a wide voltage range.
- Does not require "Top" positioning to meet FMVSS 108 standard.
- 817 kit includes light, grommet and 817-48 plug.
- 818 kit includes light and 817-48 plug.

Order No.	Description	Pack	Std Carton
817C-9	grommet mount	poly pack	6
818C-9	flange mount	poly pack	6
817KC-9	<b>KIT</b> grommet mount kit	poly pack	6
818KC-9	<b>KIT</b> flange mount kit	poly pack	6
M817C-9	grommet mount	mfg. pack	50
M818C-9	flange mount	mfg. pack	50
426-18	grommet	poly pack	12
B426-18	grommet	mfg. pack	100
417-48	hardshell plug	poly pack	6
B417-48	hardshell plug	mfg. pack	100
817-48	molded plug	poly pack	12
B817-48	molded plug	mfg. pack	100

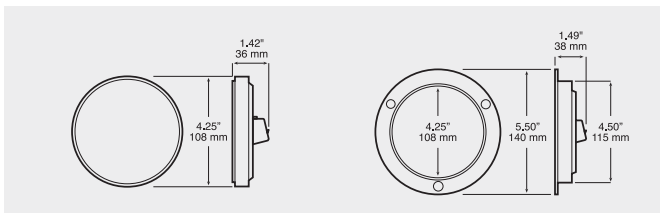

# BACK-UP, LICENSE, UTILITY & DOME



## 824-9/826-9 LumenX® LED 4" Round Back-Up Light



- Advanced optics fully illuminate lens.
- A single light meets FMVSS 108 requirements when properly mounted.
- Industry-standard PL3 socket integrated into housing.
- 824-9 has flange integrated into the housing.
- 826-9 has skirted weld joint for added protection against moisture.
- 9-32 volt operating range is compatible with 12V and 24V vehicles.
- Regulated design provides voltage protection and consistent light output over a wide voltage range.
- Does not require "Top" positioning to meet FMVSS 108 standard.
- 826 kit includes light, grommet and 431-49 plug.
- 824 kit includes light and 431-49 plug.

Order No.	Description	Pack	Std Carton
826C-9	grommet mount	poly pack	6
824C-9	flange mount	poly pack	6
826KC-9	<b>KIT</b> grommet mount	poly pack	6
824KC-9	<b>KIT</b> flange mount	poly pack	6
M826C-9	grommet mount	mfg. pack	50
M824C-9	flange mount	mfg. pack	50
426-18	grommet	poly pack	12
B426-18	grommet	mfg. pack	100
431-49	plug	poly pack	12
B431-49	plug	mfg. pack	100

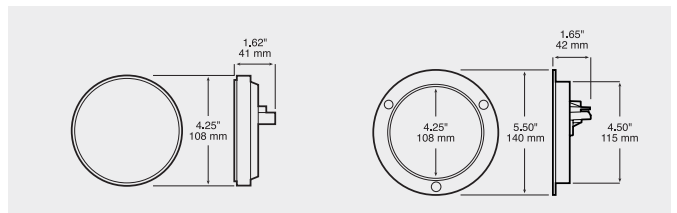

STT

TURN

MARKER

B-U/UTIL

SPEC

EMERG

ECE

MOUNT

ELECT

REFLECT

ACCY

MERCH

TECH



## 820-7/823-7 LumenX® LED Oval Back-Up Light



- A single light meets FMVSS 108 requirements when properly mounted.
- AMP-compatible connector integrated into housing.
- 823-7 has flange welded to light, forming a single unit.
- 9–16 volt operating range.
- 823CTL-7 version has integral narrower flange with recessed lens and two mounting holes positioned at ends for narrower rail applications.
- Regulated design provides voltage protection and consistent light output over a wide voltage range.
- Meets FMVSS 108 requirements in horizontal, vertical or any 360° position.
- 820 kit includes light, grommet and 817-48 plug.
- 823 kit includes light and 817-48 plug.

Order No.	Description	Pack	Std Carton
820C-7	grommet mount	poly pack	6
823C-7	flange mount	poly pack	6
820KC-7	<b>KIT</b> grommet mount kit	poly pack	6
823KC-7	<b>KIT</b> flange mount kit	poly pack	6
M820C-7	grommet mount	mfg. pack	50
M823C-7	flange mount	mfg. pack	50
M823CTL-7	narrow, 2-screw flange	mfg. pack	50
421-18	grommet	poly pack	12
B421-18	grommet	mfg. pack	100
417-48	hardshell plug	poly pack	6
B417-48	hardshell plug	mfg. pack	100
817-48	molded plug	poly pack	12
B817-48	molded plug	mfg. pack	100

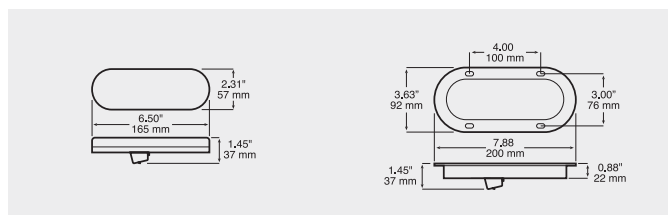

## 821-7/822-7 LumenX® LED Oval Back-Up Light



- A single light meets FMVSS 108 requirements when properly mounted.
- Industry-standard PL3 socket integrated into housing.
- 822-7 has flange welded to light, forming a single unit.
- 9–16 volt operating range.
- Regulated design provides voltage protection and consistent light output over a wide voltage range.
- Meets FMVSS 108 requirements in horizontal, vertical or any 360° position.
- 821 kit includes light, grommet and 421-49 plug.
- 822 kit includes light and 421-49 plug.

Order No.	Description	Pack	Std Carton
V821KC-7	<b>KIT</b> grommet mount kit	Viz Pack	6
V822KC-7	<b>KIT</b> flange mount kit	Viz Pack	6
821C-7	grommet mount	poly pack	6
822C-7	flange mount	poly pack	6
821KC-7	<b>KIT</b> grommet mount	poly pack	6
822KC-7	<b>KIT</b> flange mount	poly pack	6
M821C-7	grommet mount	mfg. pack	50
M822C-7	flange mount	mfg. pack	50
421-18	grommet	poly pack	12
B421-18	grommet	mfg. pack	100
421-49	plug	poly pack	12
B421-49	plug	mfg. pack	100

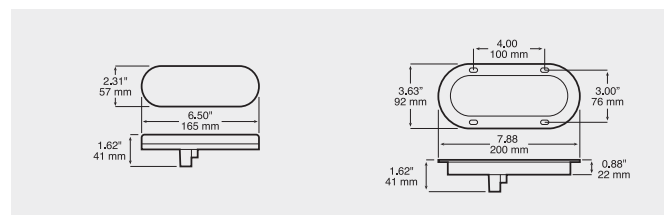

# LED BACK-UP LIGHTS



## 820-10/823-10 LumenX® LED Oval Back-Up Light



- Advanced optics fully illuminate lens.
- A single light meets FMVSS 108 requirements when properly mounted.
- AMP-compatible connector integrated into housing.
- 823-10 has flange welded to light, forming a single unit.
- 9-32 volt operating range is compatible with 12V and 24V vehicles.
- Regulated design provides voltage protection and consistent light output over a wide voltage range.
- Meets FMVSS 108 requirements in horizontal, vertical or any 360° position.
- 820 kit includes light, grommet and 817-48 plug.
- 823 kit includes light and 817-48 plug.

Order No.	Description	Pack	Std Carton
820C-10	grommet mount	poly pack	6
823C-10	flange mount	poly pack	6
820KC-10	<b>KIT</b> grommet mount kit	poly pack	6
823KC-10	<b>KIT</b> flange mount kit	poly pack	6
M820C-10	grommet mount	mfg. pack	50
M823C-10	flange mount	mfg. pack	50
421-18	grommet	poly pack	12
B421-18	grommet	mfg. pack	100
417-48	hardshell plug	poly pack	6
B417-48	hardshell plug	mfg. pack	100
817-48	molded plug	poly pack	12
B817-48	molded plug	mfg. pack	100

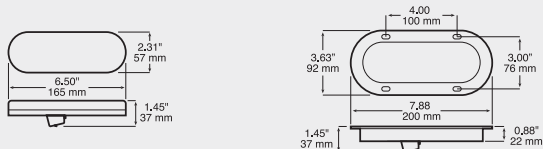

# BACK-UP, LICENSE, UTILITY & DOME



## 821-10/822-10 LumenX® LED Oval Back-Up Light



- Advanced optics fully illuminate lens.
- A single light meets FMVSS 108 requirements when properly mounted.
- Industry-standard PL3 socket integrated into housing.
- 822-10 has flange welded to light, forming a single unit.
- 9-32 volt operating range is compatible with 12V and 24V vehicles.
- Regulated design provides voltage protection and consistent light output over a wide voltage range.
- Meets FMVSS 108 requirements in horizontal, vertical or any 360° position.
- 821 kit includes light, grommet and 421-49 plug.
- 822 kit includes light and 421-49 plug.

Order No.	Description	Pack	Std Carton
821C-10	grommet mount	poly pack	6
822C-10	flange mount	poly pack	6
821KC-10	<b>KIT</b> grommet mount	poly pack	6
822KC-10	<b>KIT</b> flange mount	poly pack	6
M821C-10	grommet mount	mfg. pack	50
M822C-10	flange mount	mfg. pack	50
421-18	grommet	poly pack	12
B421-18	grommet	mfg. pack	100
421-49	plug	poly pack	6
B421-49	plug	mfg. pack	100

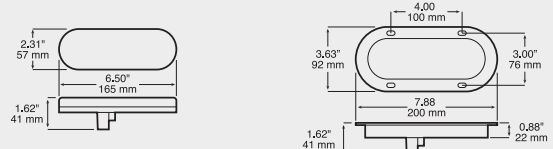



RECESSED LENS



**829-7 LumenX® LED**  
**4" Round Back-Up Light w/ Reflex**



- Optically advanced design fully illuminates lens.
- Industry-standard PL3 socket integrated into housing.
- Single light meets FMVSS 108 requirements when properly mounted.
- Flange with reflector optics integrated into housing, provides auxiliary reflex function.
- See M829R-7 for stop & tail companion model.
- 9-16 volt operating range.
- Regulated design provides voltage protection and consistent light output over a wide voltage range.
- Does not require "Top" positioning to meet FMVSS 108 standard.
- Includes protective gasket.

Order No.	Description	Pack	Std Carton
M829C-7	flange mount with reflex	mfg. pack	50
431-49	plug	poly pack	12
B431-49	plug	mfg. pack	100

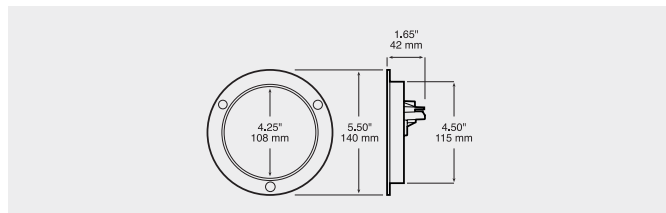

**824/826 Single Diode LED**  
**4" Round Back-Up Light**



- Single diode LED light with traditional incandescent lens look.
- Industry-standard PL3 socket integrated into housing with locking tabs for added plug retention.
- 9-32 operating range.
- Does not require "Top" positioning to meet FMVSS 108 standard.
- 826C requires 426-18 grommet.
- 824C features gray housing with integral mounting flange.
- 824C flange has recessed lens.
- 431-49 plug required for installation.

Order No.	Description	Pack	Std Carton
826C-MV	grommet mount, multi-volt	poly pack	6
824C-MV	flange mount, multi-volt	poly pack	6
M826C-MV	grommet mount, multi-volt	mfg. pack	50
M824C-MV	flange mount, multi-volt	mfg. pack	50
426-18	grommet	poly pack	12
B426-18	grommet	mfg. pack	100
431-49	plug	poly pack	12
B431-49	plug	mfg. pack	100

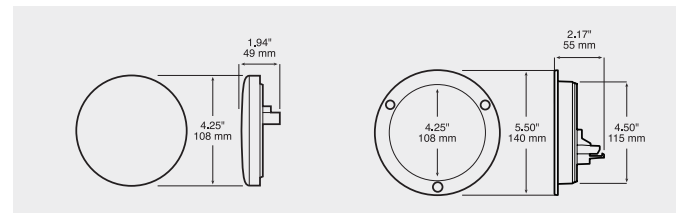



## 717 Great White® LED 7" Back-Up/Dome Light



- Round, 7-inch size popular for bus and transit applications.
- Sealed potted design.
- 9–32 volt operating range.
- Surface mount with standard 4-hole mounting pattern.
- Comes standard with mounting gasket providing additional protection between lamp and mounting surface.
- Hardwired leads terminated with .180 male bullet and ring terminal for ground.
- Matching red stop/turn/tail light available on page 16.
- Matching amber turn signal available on page 44.

Order No.	Description	Pack	Std Carton
717C	surface mount	poly pack	20

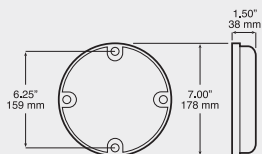

## 850C Great White® LED Rectangular Back-Up Light

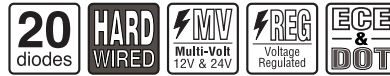

- Two versions available for mounting in either horizontal or vertical orientation.
- Meets DOT & ECE requirements when mounted as specified.
- Multi-volt design is compatible with both 12 and 24 volt systems.
- 12-inch or 6½-foot hardwired stripped leads
- 850C-1P has hardwired PL3 plug
- Matching red stop/turn/tail light available on page 16.
- Matching amber turn signal available on page 44.

Order No.	Description	Pack	Std Carton
P850C-1	vertical, 12" leads	poly pack	6
850C	vertical, 6½" leads	mfg. pack	10
850C-AMP	vertical, 12" leads w/ AMP plug	mfg. pack	10
850C-1P	vertical, 12" leads, with plug	mfg. pack	10
850C-1	vertical, 12" leads	mfg. pack	10
850HC-1	horizontal, 12" leads	mfg. pack	10
850-18	rubber grommet	poly pack	12
B850-18	rubber grommet	mfg. pack	100

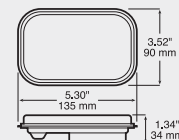

STT

TURN

MARKER

B-U/UTIL

SPEC

EMERG

ECE

MOUNT

ELECT

REFLECT

ACCY

MERCH

TECH

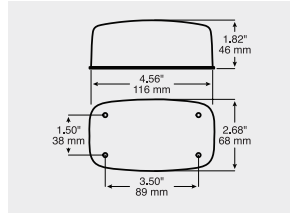

393

Back-Up Light



- Rectangular, bulb-replaceable back-up light.
- Features tough polycarbonate lens and unique pillow optics that allow maximum light output.
- Grounds through mounting screws with single lead wire for electrical connection.
- See matching 306R stop/turn/tail light on page 21.
- See matching 306A turn signal on page 49.

Order No.	Description	Pack	Std Carton
M393C	clear	poly pack	48
306-25C	replacement lens	poly pack	10
411-07	replacement pigtail	poly pack	25
1141	replacement bulb		<i>reference only</i>

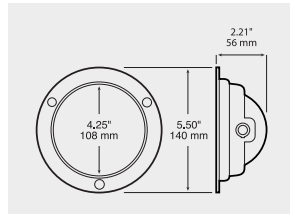

411C

4" Round Flanged Back-Up Light



- Single-wire, flush-mount 4" round back-up light
- Black polycarbonate housing with galvanized steel retainer ring
- Fits in 4 1/2" hole and secures with three screws or rivets

Order No.	Description	Pack	Std Carton
M411C	clear	mfg. pack	48
410-21	galvanized retainer ring	poly bag	25
411-24	mounting gasket	poly pack	10
411-07	replacement pigtail	poly pack	25
414-15C	replacement lens	poly pack	10
1156	replacement bulb		<i>reference only</i>

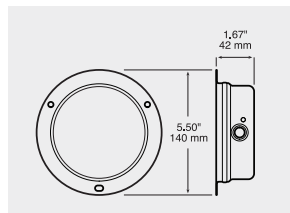

411SC

4" Round Flanged Stainless Steel Back-Up Light



- Single-wire, flush-mount 4" round back-up light
- Stainless steel housing and retainer ring
- Fits in 4 1/2" hole and secures with three screws or rivets

Order No.	Description	Pack	Std Carton
M411SC	clear, stainless steel housing	mfg. pack	48
425S-21	SS retainer ring	poly bag	25
411-24	mounting gasket	poly pack	10
411-07	replacement pigtail	poly pack	25
414-15C	replacement lens	poly pack	10
1156	replacement bulb		<i>reference only</i>



## 415/431 Sealed 4" Round Back-Up Light



- Available with standard bulb (431) or long life krypton bulb (415).
- Requires mounting grommet and 2-wire plug for installation.
- Kits include light, grommet, and plug.
- See 426A turn signal, and 426R stop/turn/tail companion models.
- Equipped with dual filament, 2.10 amp, 32 cp bulb.
- 415 series features long-life krypton bulb.
- Can be used with 3-wire plug to provide accessory low-light function.
- See LED version on page 98.

Order No.	Description	Pack	Std Carton
415	clear, long-life bulb	poly pack	12
415K	clear kit, long-life bulb	poly pack	12
M415	clear, long-life bulb	mfg. pack	48
M431C	clear	mfg. pack	50
M431KC	<b>KIT</b> clear kit	mfg. pack	50
426-18	grommet	poly pack	12
B426-18	grommet	mfg. pack	100
431-49	plug	poly pack	12
B431-49	plug	mfg. pack	100

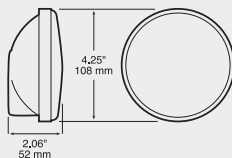

## 416 Sealed Oval Back-Up Light



- Meets DOT requirement in either horizontal or vertical position.
- Polycarbonate lens welded to housing to form single unit.
- Requires mounting grommet and 2-wire plug for installation.
- 416K kit include light, grommet, and right-angle plug.
- 12-volt lamps designed with dual filament, 2.1 amp, 32 cp bulb.
- Can be used with 3-wire plug to provide accessory low-light function.
- See LED versions on page 96–97.

Order No.	Description	Pack	Std Carton
416	clear	poly pack	12
416K	<b>KIT</b> clear kit	poly pack	12
M416	clear	mfg. pack	48
421-18	grommet	poly pack	12
B421-18	grommet	mfg. pack	100
421-49	right angle plug	poly pack	12
B421-49	right angle plug	mfg. pack	100

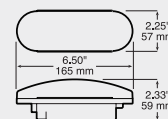

STT

TURN

MARKER

B-U/UTIL

SPEC

EMERG

ECE

MOUNT

ELECT

REFLECT

ACCY

MERCH

TECH

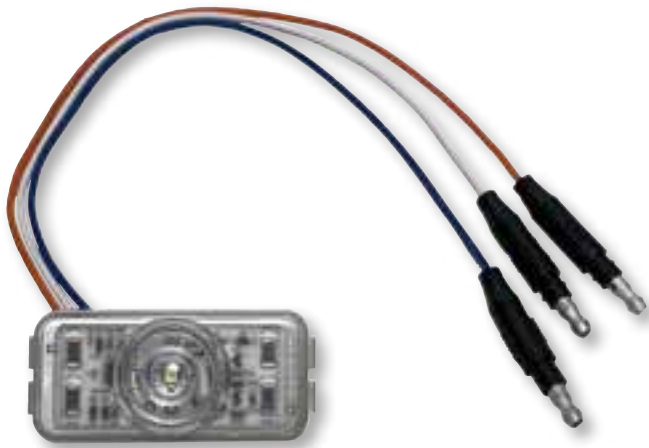

## 153CTP LED Vehicle System Monitoring Light



- Three-wire connection for test and indicator functions.
- Lights only when activated by monitored circuit. Perfect for tire pressure monitoring systems.
- Power-on self-test function lights lamp for approximately 30 seconds when power is initially applied.
- 9–16 volt operating range.
- Leads terminated with .180 bullets.
- Fits 150-091 and 150-095 brackets (See pages 175–176).

Order No.	Description	Pack	Std Carton
153CTP-BT3	white w/ .180 bullets	poly pack	6
M153CTP-BT3	white w/ .180 bullets	mfg. pack	50
150-095	mounting bracket	poly pack	12
B150-095	mounting bracket	mfg. pack	100

See pages 175–176 for additional mounting options.

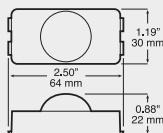

## 186CTP LumenX® Dot XL™ LED Vehicle System Monitoring Light



- White diode with SAE J575e compliant quad-flash strobe function.
- Three-wire connection for test and indicator functions.
- Power-on self test function lights for approx. 10 seconds when power is first applied.
- Strobe light function is activated by monitored circuit. Perfect for tire pressure monitoring systems.
- 9–32 volt operating range.
- Leads terminated with .180 bullets.
- 1 3/8" dia., mounts in 3/4" mounting hole with included grommet.
- Optional brackets for surface mounting available separately.

Order No.	Description	Pack	Std Carton
186CTP-BT3	white w/ .180 bullets	poly pack	6
M186CTP-BT3	white w/ .180 bullets	mfg. pack	50
B186-10	flat bracket	mfg. pack	100
B186-13	curved bracket	mfg. pack	100

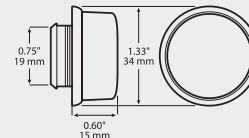



# LED LICENSE & UTILITY



## 153C LED Utility & License Light



- Meets FMVSS 108 and ECE requirements.
- Also suitable for use as compartment or utility light.
- 9-32 volt operating range.
- Fits 150-095, 150-091, 150-14, 150-141, 150-142 and 150-143 brackets (See pages 175-177).
- 153C-P terminated with 2-wire female plug for easy installation.
- 153C-BT2 terminated with .180 bullets.
- M153C-MV-PKD terminated with Packard-style hardshell connector.
- V153KC-MV Viz Pack kit includes light and 150-095 bracket.
- 153C-142 kit includes M153C-MV and B150-142 bracket.
- 153C-JAMP includes an AMP-compatible connector and 12" jacketed lead.

Order No.	Description	Pack	Std Carton
V153KC-MV	<b>KIT</b> white kit w/ bracket	Viz Pack	6
153C-MV	white	poly pack	6
153C-P	white w/ PL10 plug	poly pack	6
153C-BT2	white w/ .180 bullets	poly pack	6
153C-142	<b>KIT</b> white kit w/ hooded bracket	poly pack	6
M153C-MV	white	mfg. pack	50
M153C-P	white w/ plug	mfg. pack	50
M153C-BT2	white w/ .180 bullets	mfg. pack	50
M153C-JAMP	w/ jacketed AMP connector	mfg. pack	50
M153C-MV-P	white w/ plug	mfg. pack	50
M153C-MV-PKD	white w/ hardshell connector	mfg. pack	50
150-095	mounting bracket	poly pack	12
B150-095	mounting bracket	mfg. pack	100
B150-142	hooded bracket, black	mfg. pack	50

See pages 175-177 for additional mounting options.

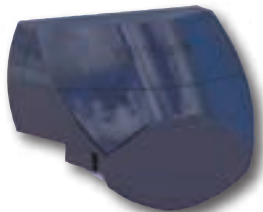

153C-142 kit includes light plus 150-142 hooded bracket.



V153KC-MV kit includes light plus 150-095 bracket

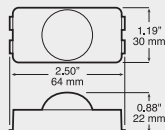

# BACK-UP, LICENSE, UTILITY & DOME



## 168C Great White® LED Mini Utility Light



- LED utility, interior, compartment, courtesy or auxiliary light.
- Not for use as legally-required marker or license light.
- Two Great White® LEDs provide brilliant white light.
- 9-16 volt operating range.
- Mounts on 1-15/16" centers
- 168-10K kit includes 168-10 chrome bezel and 168-182 gasket.
- 168-092K kit includes 168-092 chrome bezel and 168-181 gasket.
- Optional bracket allows for mounting on 1-15/16" or 1-1/8" centers.
- Mounting gasket, bracket, or chrome bezel available separately.

Order No.	Description	Pack	Std Carton
168C	white	poly pack	12
M168C	white	mfg. pack	50
168-09	black bracket	poly pack	12
B168-09	black bracket	mfg. pack	100
168-10K	<b>KIT</b> chrome bezel w/ gasket	poly pack	12
B168-10	chrome bezel	mfg. pack	100
168-18	mounting gasket	poly pack	12
B168-18	mounting gasket	mfg. pack	100
168-092K	<b>KIT</b> aluminum bracket w/ gasket	poly pack	12
B168-092	aluminum bracket	mfg. pack	50

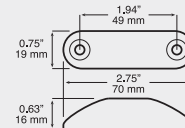

168-09



168-18

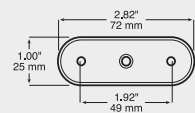
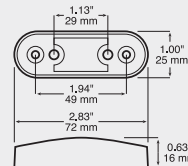



Actual Size

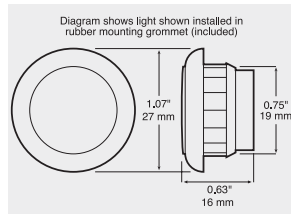

**171 LED Great White® LED Dot Light™ 1-Diode Utility Light**



- Fits 3/4" hole.
- Black rubber grommet Included.
- 9-16 volt operating range.
- Stripped, 8" hardwired leads.
- M171C-BT2 terminated with .180 bullets
- M171W-MV-BT2 multi-volt version available.

Order No.	Description	Pack	Std Carton
V171C	<b>KIT</b> white, stripped leads	Viz Pack	3
171KC	<b>KIT</b> white, stripped leads	poly pack	6
171KC-BT2	<b>KIT</b> white w/ .180 bullets	poly pack	6
M171C	<b>KIT</b> white, stripped leads	mfg. pack	50
M171C-BT2	<b>KIT</b> white w/ .180 bullets	mfg. pack	50
M171W-MV-BT2	<b>KIT</b> white w/ .180 bullets, multi-volt	mfg. pack	50



**178W Great White® LED Oval Dome & Utility Light**



- Can be surface mounted almost anywhere as a courtesy or dome light.
- Multi-volt design is compatible with both 12 and 24 volt systems.
- Hardwired with separate lead and ground wires.
- Mounts on 4" centers.
- Optional chrome bezel available.

Order No.	Description	Pack	Std Carton
178W-MV	clear	poly pack	12
M178W-MV	clear	mfg. pack	50
178-10	chrome bezel	poly pack	12
B178-10	chrome bezel	mfg. pack	100



B178-10 Bezel

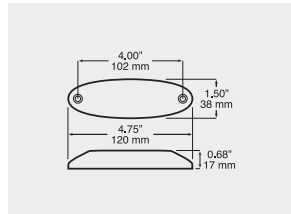

**186W LumenX® Dot XL™ LED Utility Light**



- 1-3/8" diameter, single-diode LED utility light.
- Mounts in 3/4" diameter hole.
- Lens is welded to housing to form single rugged unit.
- Hardwired design with two .180 bullet-terminals.
- 9-16 voltage operating range.
- Rubber grommet included.

Order No.	Description	Pack	Std Carton
M186W-BT2	white	mfg. pack	50

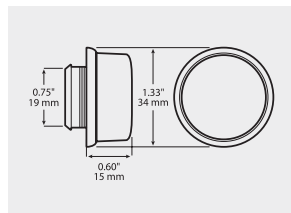

**UTILITY  
& AUX**



290

**TOP  
MOUNT**



290C



**SIDE  
MOUNT**



290C-SM



**BRACKET  
MOUNT**



290B-P

## 290 Single Diode LED License & Utility Light



- Surface-mounts on 2" centers.
- Single license light is DOT-compliant when used properly with spacer.
- Available in either 12 volt, or multi-volt ("MV") for 12V & 24V systems.
- 290C versions have 0.95" spacer for use as top mount license light.
- 290B-P consists of a 290C permanently attached to a polymer license plate bracket.
- 290C-SM versions have 1.60" spacer for use as side mount license light.
- 290 comes without spacer for use as low-profile utility light.

Order No.	Description	Pack	Std Carton
V290	utility light	Viz Pack	6
V290C	license light, top mount	Viz Pack	6
290	utility light	poly pack	12
290B-P	license light w/ poly license plate brkt	poly pack	6
290-BT2	utility light, .180 bullets	poly pack	12
290C	license light, top mount	poly pack	12
290C-AMP	license light, top, AMP plug	poly pack	12
290C-BT2	license light, top, .180 bullets	poly pack	12
290-MV	utility light, multi-volt	poly pack	12
290C-MV	license light, top mount, multi-volt	poly pack	12
290C-SM	license light, side mount	poly pack	12
290C-SM-BT2	license light, side mount, .180 bullets	poly pack	12
M290	utility light	mfg. pack	50
M290-MV	utility light, multi-volt	mfg. pack	50
M290B-P	license light with poly bracket	mfg. pack	24
M290-BT2	utility light, .180 bullets	mfg. pack	50
M290C	license light, top mount	mfg. pack	50
M290C-AMP	license light, top, AMP plug	mfg. pack	50
M290C-BT2	license light, top, .180 bullets	mfg. pack	50
M290C-MFP	license light, top, male/female bullets	mfg. pack	50
M290C-MV	license light, top mount, multi-volt	mfg. pack	50
M290C-SM	license light, side mount	mfg. pack	50
M290C-SM-BT2	license light, side mount, .180 bullets	mfg. pack	50
M290C-SM-PKD	license light, side mount, Packard plug	mfg. pack	50
290-09	spacer bracket, top mount	poly pack	12
290-091	spacer bracket, side mount	poly pack	12

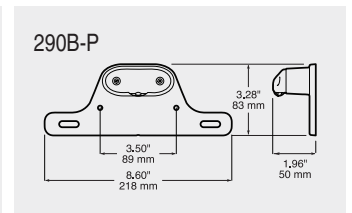
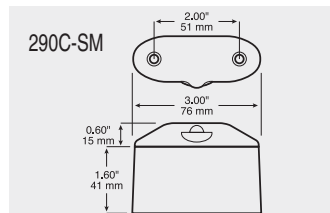
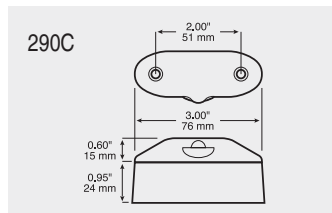
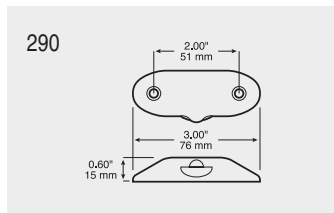



## 203 LED License Plate/Utility Light



- Polycarbonate lens and base are welded together to form a single rugged unit.
- LED version of our popular 150 series light.
- Side of 203C lens painted to meet license illuminator requirements.
- 203W has clear lens for utility use only.
- V203W includes 150-09 mounting bracket, gasket, and two screws.
- Interchangeable with competitive units.
- Requires mounting bracket and plug to complete installation.
- See pages 175–177 for additional mounting options.

Order No.	Description	Pack	Std Carton
V203C	clear/painted license light	Viz Pack	6
V203W	<b>KIT</b> utility light kit with bracket	Viz Pack	6
203C	clear/painted license light	poly pack	12
203W	utility light	poly pack	12
M203C	clear/painted license light	mfg. pack	50
M203W	utility light	mfg. pack	50
150-09	gray bracket	poly pack	12
150-14	gray license light bracket	poly pack	24
B150-14	gray license light bracket	mfg. pack	100
150-141	black license light bracket	poly pack	24
B150-141	black license light bracket	mfg. pack	100
142-49	plug	poly pack	12
B142-49	plug	mfg. pack	100



150-141 mounting bracket



150-09 mounting bracket

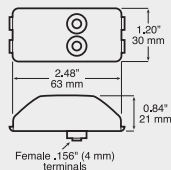

## 250W Single Diode LED Utility Light



- Single-diode LED utility light.
- Lens is welded to housing to form single rugged unit.
- Hardwired design with two .180 bullet-terminals.
- 9-16 voltage operating range.

Order No.	Description	Pack	Std Carton
M250W-BT2	white	mfg. pack	50
150-095	surface mount bracket	poly pack	12
B150-095	surface mount bracket	mfg. pack	100
B150-18	rubber grommet	mfg. pack	100

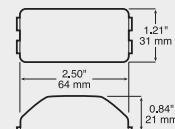



## 291C Single Diode LED 3/4" License Light



- Compact single diode design fits 3/4" hole.
- A single light meets DOT requirements when mounted properly above the center of the license plate.
- Features theft deterrent locking ring.
- 9-16 voltage operating range.
- Available with AMP plug or 8" or 36" leads with double .180 bullets.
- Includes mounting grommet.

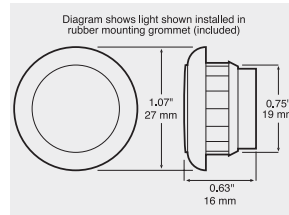

Order No.	Description	Pack	Std Carton
291KC-BT2	<b>KIT</b> 8" leads w/ .180 bullets	poly pack	6
M291C-AMP	<b>KIT</b> AMP plug	mfg. pack	100
M291C-BT2	<b>KIT</b> 8" leads w/ .180 bullets	mfg. pack	100
M291C-BT236	<b>KIT</b> 36" leads w/ .180 bullets	mfg. pack	100

## 296 LED License Light



296XC

296C

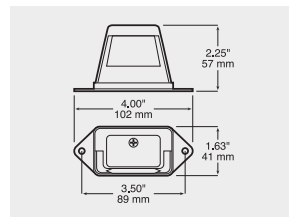

- Durable, low amp draw LED design with hardwired leads & metal base.
- Specially-designed optics for optimal light dispersal.
- A single unit meets DOT requirements when mounted above license plate.
- Requires two lights to meet DOT requirements when mounted to side of license plate.
- "XC" version features attractive chrome finish.

Order No.	Description	Pack	Std Carton
V296XC	chrome	Viz Pack	6
M296C	black	mfg. pack	50
M296XC	chrome	mfg. pack	50
M296C-PKD	black with Packard plug	mfg. pack	50

## 298 LED License & Utility Light



- Durable, low amp draw LED design with hardwired leads.
- Requires two lights to meet DOT requirements.
- Also suitable for utility courtesy light applications.
- Hardwired leads.
- Durable, attractive chrome finish.

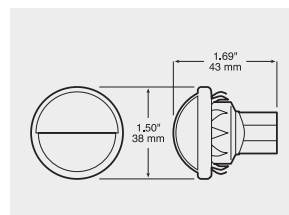

Order No.	Description	Pack	Std Carton
V298C	chrome	Viz Pack	6
298C	chrome	poly pack	12
M298C	chrome	mfg. pack	20
M298C-BT2	chrome w/ .180 bullets	mfg. pack	20

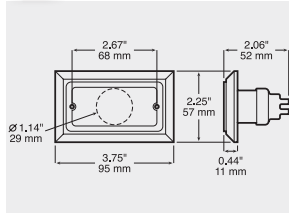

**126**  
**Compact Courtesy Light**



- Rectangular interior, compartment, courtesy, or general illumination utility light with chrome-plated ABS housing.
- Mounts on 2 11/16" centers using lens screws as mounting hardware.
- Twist-in socket assembly contains both lead wire and ground wire for mounting on all surfaces.
- Requires 1 1/4" socket mounting hole for installation.

Order No.	Description	Pack	Std Carton
M126C	clear, chrome	mfg. pack	96
126-25C	replacement lens	poly pack	10
193	replacement bulb		<i>reference only</i>

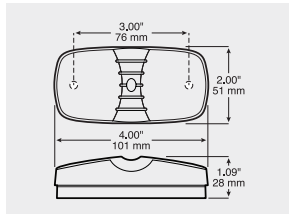

**138**  
**Double Bulls-Eye Utility Light**



- Popular two-bulb light designed for various utility uses.
- Acrylic lens snaps onto housing.
- Surface mounts on 3" centers.
- Unit has single lead wire for electrical connections and grounds through mounting screws.

Order No.	Description	Pack	Std Carton
M138C	clear	mfg. pack	100
B138-15C	replacement lens	bulk pack	100
193/194	replacement bulb		<i>reference only</i>

**146 Sealed**  
**2" Utility Light**



- Popular 2" clear light is perfect as general illumination utility light.
- High impact resistant lens welded to the housing to form single sealed unit.
- Features 15,000-hour-rated long-life bulb.
- Requires grommet and 2-wire plug to complete installation.
- See mounting accessories for additional mounting options.

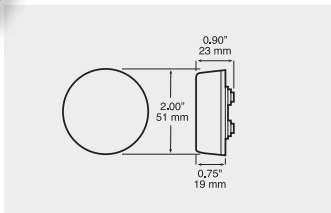

Order No.	Description	Pack	Std Carton
146C	clear	poly pack	24
M146C	clear	mfg. pack	100
146-18	grommet	poly pack	12
B146-18	grommet	mfg. pack	100
142-49	plug	poly pack	12
B142-49	plug	mfg. pack	100



150-09 mounting bracket



150-141 mounting bracket

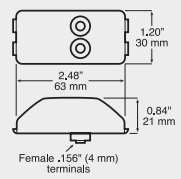

## 150 Sealed License Plate/Utility Light



- Side of 150C lens painted to meet license illuminator requirements.
- 150W has clear lens for utility use only.
- 150KC includes 150C light and 150-14 gray bracket.
- Interchangeable with competitive units.
- Requires mounting bracket and plug to complete installation.
- See pages 175–177 for additional mounting options.
- See 203C/203W LED version on page 106.

Order No.	Description	Pack	Std Carton
V150C	clear/painted	Viz Pack	6
V150W	clear	Viz Pack	6
150C	clear/painted	poly pack	24
150KC	<b>KIT</b> clear/painted w/ gray bracket	poly pack	6
150W	clear	poly pack	6
M150C	clear/painted	mfg. pack	100
M150W	clear	mfg. pack	100
150-09	gray bracket	poly pack	12
150-14	gray license light bracket	poly pack	24
B150-14	gray license light bracket	mfg. pack	100
150-141	black license light bracket	poly pack	24
B150-141	black license light bracket	mfg. pack	100
142-49	plug	poly pack	12
B142-49	plug	mfg. pack	100

## 154 Sealed License Plate/Utility Light



- Polycarbonate lens & housing welded as single unit for maximum protection.
- Same quality features as 150C in two-bulb design.
- Requires mounting bracket and plug to complete installation.
- See page 177 for mounting options.



154-09K mounting bracket

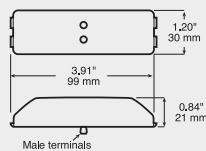

Order No.	Description	Pack	Std Carton
154C	clear/painted	poly pack	24
M154C	clear/painted	mfg. pack	100

## 394C Step Well Utility Light



- Features chrome-plated brass housing and hood, with glass lens.
- Durable neoprene mounting pad.
- Perfect utility light for bus or RV applications.
- May be mounted vertically or horizontally.
- Includes single lead wire and grounds through mounting screws.

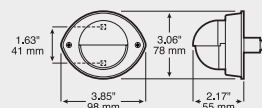

Order No.	Description	Pack	Std Carton
M394C	clear, with hood	mfg. pack	50
1141	21 cp replacement bulb		reference only

STT  
TURN  
MARKER  
B-U/UTIL  
SPEC  
EMERG  
ECE  
MOUNT  
ELECT  
REFLECT  
ACCY  
MERCH  
TECH

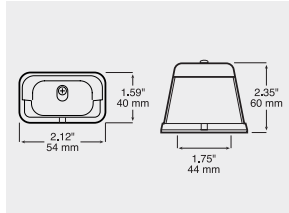

**400**  
**License Plate Light**



- Features our patented Vibar® socket and single lens screw for easy bulb replacement.
- Meets DOT requirements when mounted above license plate.
- Polycarbonate lens and ABS housing provide protection against damage and all internal parts are corrosion-resistant.
- Surface mounts with two screws on 1 3/4" centers.
- Grounds through the mounting screws.

Order No.	Description	Pack	Std Carton
400	clear	poly pack	24
M400	clear	mfg. pack	48
168	replacement bulb		<i>reference only</i>

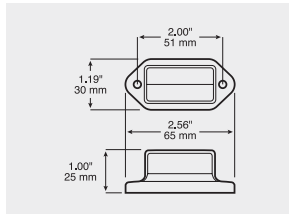

**434**  
**Mini Utility/Courtesy Light**



- Features bright metal housing with hooded shield to prevent upward glare.
- Surface mounts with two stainless-steel screws on 2" centers.
- Separate ground wire for non-metallic surfaces.

Order No.	Description	Pack	Std Carton
V434	clear	Viz Pack	6
M434	clear	mfg. pack	100
193/194	replacement bulb		<i>reference only</i>

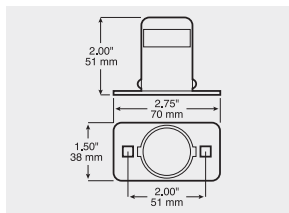

**435**  
**Chrome License Plate Light**



- Features chrome-plated steel housing and mounting bracket.
- Traditional style, bulb-replaceable light surface mounts on 2" centers and grounds through mounting screws.
- Interchangeable with competitive models.
- Meets FMVSS108 requirements when used in pairs. Lights must be mounted 2"-3" above license plate, 6" apart.

Order No.	Description	Pack	Std Carton
V435	clear	Viz Pack	6
435	clear	poly pack	24
M435	clear	mfg. pack	48
67	replacement bulb		<i>reference only</i>





436

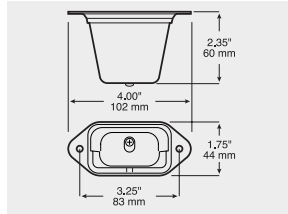

436B

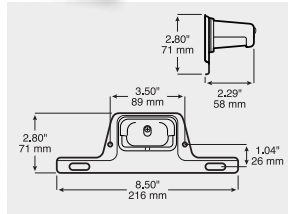

436B-P

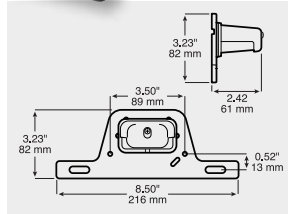

## 436

### License Plate Light



- Features patented Vibar® socket, tough polycarbonate lens, and ABS hood.
- All internal parts are durable stainless-steel or tinned-brass.
- Surface mounts on 3 1/4" centers.
- 436B includes black powder-coated, steel license plate bracket riveted to light.
- 436B-P includes black polypropylene bracket riveted to light; has separate ground wire.
- 436 and 436B ground through mounting hardware.
- See 296 LED version on page 107.

Order No.	Description	Pack	Std Carton
436	clear	poly pack	24
M436	clear	mfg. pack	48
M436B	clear with steel bracket	mfg. pack	24
M436B-P	clear with poly bracket	mfg. pack	24
436-25	replacement lens	poly pack	10
436-01	gray housing	poly pack	24
168	replacement bulb		<i>reference only</i>

## 436X Chrome, Stud-Mount License Plate Light



- Features our patented Vibar® socket and single lens screw for easy bulb replacement.
- Chrome-plated version of 436 light with stud mount.
- Ideal as replacement light for foreign car license illuminators or for customizing trucks, vans, and trailers.
- Single lead wire for electrical connection; grounds through mounting bolts.

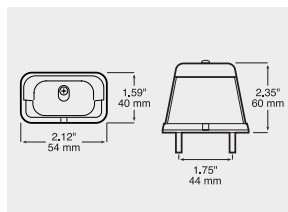

Order No.	Description	Pack	Std Carton
V436SX	clear	Viz Pack	6
436SX	clear	poly pack	24
436-25	replacement lens	poly pack	10
168	replacement bulb		<i>reference only</i>

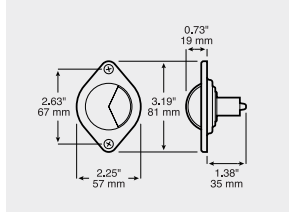

437

Chrome License Plate/Utility Light



- Features chrome-plated hood, steel housing, and polycarbonate lens.
- 437 includes single lead wire with molded .156 bullet terminal and grounds through mounting hardware.
- Similar to styling on some GM vehicles.
- Requires 2" mounting hole.
- Two units required for legal license illumination.

Order No.	Description	Pack	Std Carton
V437	clear	Viz Pack	6
M437	clear	mfg. pack	48
67	replacement bulb		reference only

432 Chrome / 438 Sealed Chrome License Plate/Utility Light

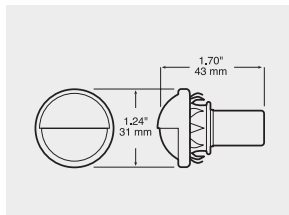

- Chrome-plated steel light snaps into 1 1/4" diameter hole (overall diameter is 1 1/2").
- Commonly used to illuminate license plate on step bumpers.
- Two units required for legal license illumination.
- Also serves as perfect interior, compartment, courtesy, or general illumination utility light.
- 438 series is sealed with single 5.5" lead wire.
- 432 series is bulb replaceable with twist-in rubber socket and dual 14" lead wires.
- See 298 LED version on page 107.

Order No.	Description	Pack	Std Carton
V432	clear, bulb replaceable	Viz Pack	6
V438	clear, sealed	Viz Pack	6
438	clear, sealed	poly pack	20
M432	clear, bulb replaceable	mfg. pack	50
M438	clear, sealed	mfg. pack	100
168	replacement bulb		reference only

439 Sealed License Plate Light

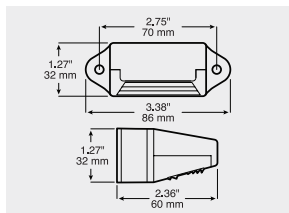

- Popular style sealed, surface mount license light.
- Polycarbonate lens and housing are sonic welded for water-tight seal.
- Mounts on 2 3/4" centers.
- Requires 142-49 plug for electrical connection.

Order No.	Description	Pack	Std Carton
M439	clear	mfg. pack	48
142-49	plug	poly pack	12
B142-49	plug	mfg. pack	100

# LED DOME & INTERIOR LIGHTS



All lengths available with wires on both ends



## 362/363/364 Great White® LED Interior Strip Light



- Fully potted construction, yet very flexible.
- Installs easily with super-strong "press-in-place" adhesive backing.
- Available in 12", 24" & 47" lengths.
- "-2" versions have leads on both ends for daisy-chaining to 16' max.
- 9-16 voltage operating range.
- Perfect for aisle lighting and use in service bodies.
- Each manufacturer pack contains ten (10) strips per inner bag *except* M362-1-BT2, M364-1, M364-1-BT2 and M364-1PKD.
- Poly pack contains one strip per bag.

Order No.	Description	Pack	Std Carton
362-1	12" single lead wire	poly pack	10
362-2	12" lead wires on both ends	poly pack	10
363-1	24" single lead wire	poly pack	10
363-2	24" lead wires on both ends	poly pack	10
M362-1	12" single lead wire	mfg. pack	10
M362-1-BT2	12" single lead wire, .180 bullets	mfg. pack	100
M362-2	12" lead wires on both ends	mfg. pack	10
M362-2-BT2	12" leads both ends, .180 bullets	mfg. pack	100
M363-1	24" single lead wire	mfg. pack	10
M363-1-BT2	24" single lead, .180 bullets	mfg. pack	10
M363-1PKD	24" single lead, Packard plug	mfg. pack	10
M363-2	24" lead wires on both ends	mfg. pack	10
M363-2-BT2	24" leads both ends, .180 bullets	mfg. pack	100
M364-1	47" single lead wire	mfg. pack	6
M364-1-BT2	47" single lead, .180 bullets	mfg. pack	100
M364-1PKD	47" single lead, Packard plug	mfg. pack	100

# BACK-UP, LICENSE, UTILITY & DOME



## 360 Great White® LED Rectangular Dome Light

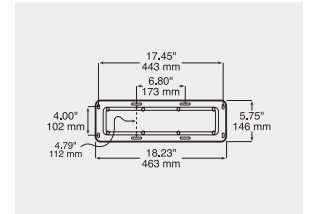

- LED dome and interior light is perfect for dry van trailer applications.
- Mounts flush; thin design extends only 0.86" below mounting surface.
- 9-32 volt operating range.
- Fully potted circuit board.
- Available with polycarbonate or aluminum housing.
- Hard-wired with dual 8" long, 14 ga. stripped leads.
- Operating temperature -40 to +122 F (-40 to +50 C).

Order No.	Description	Pack	Std Carton
M360-1	polycarbonate, stripped leads	mfg. pack	1
M360	aluminum housing, stripped	mfg. pack	10
M360-BT2	aluminum, .180 bullets	mfg. pack	10



## 365 Great White® LED Motion Sensing Dome Light

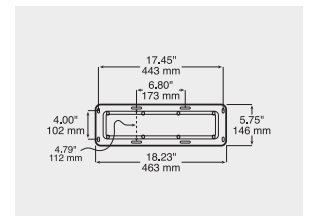

- LED dome and interior light.
- Built-in motion sensor automatically activates light.
- Light stays illuminated for approx. 5 minutes unless new motion occurs.
- Mounts flush, thin design extends only 0.86" below mounting surface.
- 9-32 voltage operating range.
- Rugged aluminum housing and potted circuit board.
- Hardwired with dual 8.5" long, 14 gauge stripped leads or .180 bullet terminals.

Order No.	Description	Pack	Std Carton
M365	white, stripped leads	mfg. pack	10
M365-BT2	white, .180 bullets	mfg. pack	10

STT  
TURN  
MARKER  
B-U/UTIL  
SPEC  
EMERG  
ECE  
MOUNT  
ELECT  
REFLECT  
ACCY  
MERCH  
TECH

**300  
to 1,000  
Lumens**

**[PATENTED]**



Scan with smartphone to learn more!

**SEALED  
Suitable for  
exterior use**



Optimized profile and flat mounting tabs on both ends easily screw-mount to flat surfaces.



See page 215 to learn more about our 5600 series timer switch – the perfect companion to our LED interior lights!

**358 Great White® LED  
Dome / Interior Light**



- Available in 6", 12" and 18" lengths.
- Easy and versatile surface screw mounting; ideal for center ceiling mount in step vans and service bodies.
- Multi-volt design is compatible with both 12V and 24V systems.
- Available with either stripped leads or terminated with .180 bullets.
- Integral, IP68-rated molded seal resists dust, moisture and vapors.
- Optional timer switch available separately.
- The 18-inch version is available with wires at both ends for daisy-chaining multiple lights together.
- Optional timer switch available separately; see page 215.

Order No.	Description	Lumens	Pack	Std Carton
358-1	6" long, stripped leads	300	poly pack	12
358-2	12" long, stripped leads	500	poly pack	12
358-3	18" long, stripped leads	1000	poly pack	12
M358-1	6" long, stripped leads	300	mfg. pack	50
M358-1-BT2	6" long, .180 bullets	300	mfg. pack	50
M358-2	12" long, stripped leads	500	mfg. pack	50
M358-2-BT2	12" long, .180 bullets	500	mfg. pack	50
M358-3	18" long, stripped leads	1000	mfg. pack	50
M358-3-BT2	18" long, .180 bullets	1000	mfg. pack	50
M358-4	18" long, dual-end stripped leads	1000	mfg. pack	50
M358-4-BT2	18" long, dual-end .180 bullets	1000	mfg. pack	50

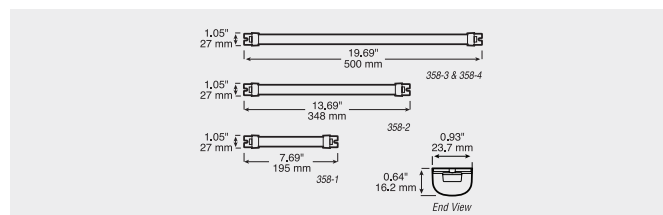

# LED DOME & INTERIOR LIGHTS

**300  
to 1,000  
Lumens**

**[PATENTED]**



Scan with smartphone  
to learn more!

**SEALED**  
Suitable for  
exterior use



Mounts easily to horizontal or vertical surfaces,  
or fits in corners using either screws or available  
snap-in channel clip (sold separately).

See page 215 to learn more about our  
5600 series timer switch – the perfect  
companion to our LED interior lights!



# BACK-UP, LICENSE, UTILITY & DOME

## 359 Great White® LED Dome/Interior Light



- Available in 6", 12" and 18" lengths.
- More effective light distribution than recessed dome lights.
- No mounting pan needed, so the R-value of insulated cargo areas is not reduced.
- Easy and versatile surface screw mounting on any vertical or horizontal surface.
- Multi-volt design is compatible with both 12V and 24V systems.
- Available with either stripped leads or terminated with .180 bullets.
- Integral, IP68-rated molded seal resists dust, moisture and vapors.
- Accessory cove molding facilitates easy wiring for retrofits.
- Optional timer switch available separately; see page 215.

Order No.	Description	Lumens	Pack	Std Carton
359-1	6" long, stripped leads	300	poly pack	12
359-2	12" long, stripped leads	500	poly pack	12
359-3	18" long, stripped leads	1000	poly pack	12
M359-1	6" long, stripped leads	300	mfg. pack	50
M359-1-BT2	6" long, .180 bullets	300	mfg. pack	50
M359-2	12" long, stripped leads	500	mfg. pack	50
M359-2-BT2	12" long, .180 bullets	500	mfg. pack	50
M359-3	18" long, stripped leads	1000	mfg. pack	50
M359-3-BT2	18" long, .180 bullets	1000	mfg. pack	50
M359-4	18" long, dual-end stripped leads	1000	mfg. pack	50
M359-4-BT2	18" long, dual-end .180 bullets	1000	mfg. pack	50
B359-10	snap-in channel clip		mfg. pack	100

The 18-inch version is available with  
wires at both ends for daisy-chaining  
multiple lights together.



Engineering tests illustrate how  
ineffectively the traditional arrangement  
of recessed ceiling dome lights  
illuminate this 53' insulated reefer trailer.

The same trailer with our new  
359-3 lights installed is much more  
efficiently lit, despite lower costs per  
front and over the life of the trailer.

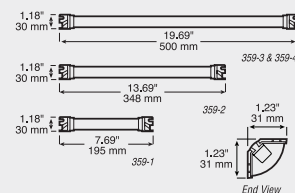

**400 Lumens**

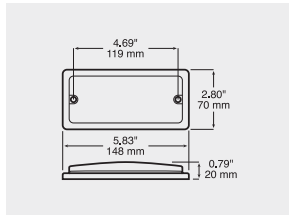

**368 Great White® LED Dome/Interior Light**



- 5.8" x 2.8" rectangular LED dome and interior light.
- White plastic housing and clear lens.
- Separate lead and ground wires included.
- Available with stripped leads.
- Mounts on 4-11/16" (119 mm) centers.
- For interior use only.
- 9–32 voltage operating range.
- Replaces V366 series.

Order No.	Description	Pack	Std Carton
V368	white, stripped leads	Viz Pack	6
368	white, stripped leads	poly pack	12
M368	white, stripped leads	mfg. pack	50

**230 Lumens**

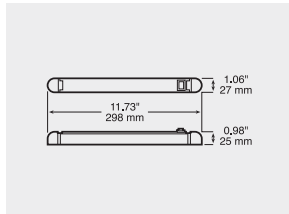

**369 Great White® LED Rotating Interior Light w/ Switch**



- 12" interior swivel rail light.
- Equipped with on-off switch.
- White plastic housing & clear lens.
- Hardwired with separate lead and ground wire.
- For interior use only.
- 10–30 voltage operating range.

Order No.	Description	Pack	Std Carton
V369S	white	Viz Pack	4

**130 Lumens**

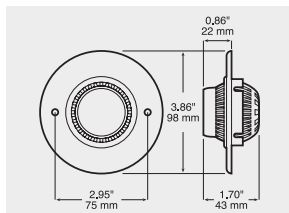

**370 Great White® LED Interior Swivel Light**



- Long-life LED design.
- Swivels to direct beam where needed.
- Low-glare reflector housing.
- Polished metal base.
- 10–30 volt operating range.
- Hardwired with Tyco Mate-N-Lok connector.

Order No.	Description	Pack	Std Carton
M370	round	mfg. pack	50

# LED DOME & INTERIOR LIGHTS

# BACK-UP, LICENSE, UTILITY & DOME



371S

**130 Lumens**



371

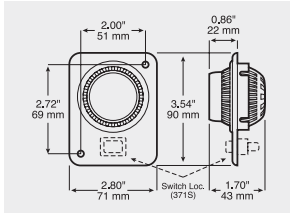

## 371 Great White® LED Interior Swivel Light



- Long-life LED design.
- Swivels to direct beam where needed.
- Low-glare reflector housing.
- Brushed-finish metal base.
- 10–30 volt operating range.
- Available with or without on/off switch.
- Includes TE Mate-N-Lok connector, #1-480699-0.

Order No.	Description	Pack	Std Carton
M371	rectangular base	mfg. pack	50
M371S	rectangular w/ switch	mfg. pack	50



**300 Lumens**

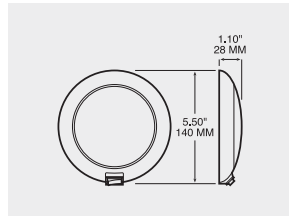

## 379 Great White® LED Dome/Interior Light w/ Switch



- 5.5" diameter round dome light.
- Equipped with on-off switch.
- White plastic housing & clear lens.
- Lens removes for mounting.
- For interior use only.
- 10–30 volt operating range.

Order No.	Description	Pack	Std Carton
V379S	white	Viz Pack	4



**70 Lumens**

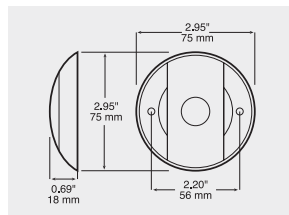

## 381 Great White® LED Dome/Interior Light



- Round dome light with black or chrome bezel
- General illumination for interior applications
- 9–16 volt operating range
- Two hardwired leads

Order No.	Description	Pack	Std Carton
V381X	chrome	Viz Pack	6
M381	black	mfg. pack	50
M381X	chrome	mfg. pack	50

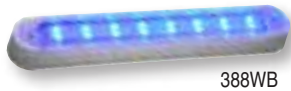

388WB

**80 Lumens**



388C

Comes with custom surface-mount bracket, or can be flush-mounted without bracket

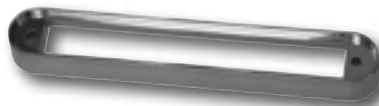
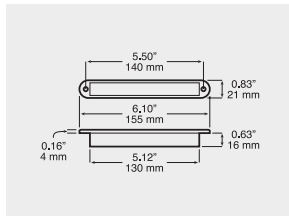

Optional B388-09X chrome bracket

## 388C Great White® LED Int/Ext Aisle & Utility Light



- Includes bracket for surface mounting, or can be recess-mounted.
- 388C features Great White® diodes and black bracket.
- 388WB features blue diodes and white bracket; great for marine use!
- Optional chrome accessory bracket available.
- Recessed or surface mount LED strip light.
- Multi-volt design is compatible with both 12 and 24 volt systems.
- Low amp draw.
- Perfect for aisle lighting.

Order No.	Description	Pack	Std Carton
V388C	white w/ black bracket	Viz Pack	6
V388WB	blue w/ white bracket	Viz Pack	6
388C	white w/ black bracket	poly pack	12
388WB	blue w/ white bracket	poly pack	12
M388C	white w/ black bracket	mfg. pack	10
M388WB	blue w/ white bracket	mfg. pack	10
388-09X	chrome bracket	poly pack	12
B388-09X	chrome bracket	mfg. pack	50



**130 Lumens**

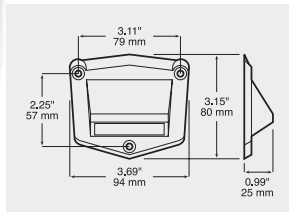

## 397 LED Step Well Courtesy Light



- Low profile, hardwired design meets ADA requirements for step well lighting.
- Perfect for transit, bus & RV use.
- Multi-volt design is compatible with both 12 and 24 volt systems.
- Sealed circuit board with two hardwired leads.
- Includes mounting gasket, 3 mounting screws and 3 matching screw covers.

Order No.	Description	Pack	Std Carton
397C	black, stripped leads	poly pack	12
M397C	black, stripped leads	mfg. pack	50



**500 Lumens**

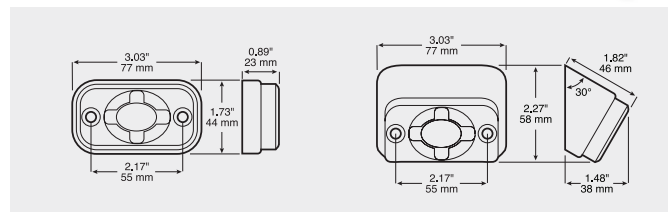

398-BT2

399-BT2

## 398/399 Great White® LED 3" x 1.75" Rectangular Work Light



- White diodes behind clear lens.
- Cast alloy housing.
- Two mounting bases; flat/perpendicular (398) or angled (399)
- Wide even flood pattern with 500 lumen output.
- Two 20" jacketed lead wires terminated with .180 bullet connectors
- 10–30 volt operating range
- -22° F–120° F operating temperature range
- Includes rubber mounting base
- IP67 / IP69K ingress protection rating
- Draws 0.39 amps @ 12V, 0.20 amps @ 24V

Order No.	Description	Pack	Std Carton
398-BT2	white flood pattern, flat base	poly pack	6
M398-BT2	white flood pattern, flat base	mfg. pack	60
M399-BT2	white flood, wedge base	mfg. pack	60



**50 Lumens**

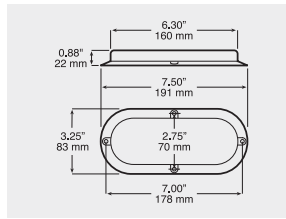

## 423W-4 Great White® LED Int/Ext Dome & Utility Light

**10** diodes **HARD WIRED** **MV** Multi-Volt 12V & 24V

- Features 10 bright Great White® diodes behind clear lens.
- Sealed lens and housing.
- 9–32 volt operating range works with both 12V and 24V systems.
- Hardwired design.
- Easy surface mounting.
- Attractive accessory chrome bezel available.

Order No.	Description	Pack	Std Carton
423W-4	white	poly pack	6
M423W-4	white	mfg. pack	50
423-11	chrome bezel	poly pack	12
B423-11	chrome bezel	mfg. pack	50

**400 Lumens**

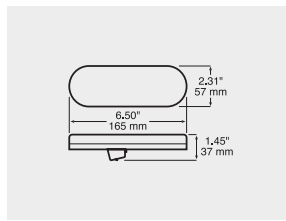

## 870W LumenX® LED Oval Touch-On, Touch-Off Interior/Dome Light

**10** diodes **LumenX** **USA MADE** **HARD WIRED** **MV** Multi-Volt 12V & 24V **REG** Voltage Regulated

- Turns on and off with a simple touch of the lens surface.
- 400 lumen max output.
- Lens is welded to housing to form single unit.
- 9–32 volt operating range is compatible with 12V and 24V systems.
- Mounts in grommet or surface-mount bracket.
- Surface-mount bracket available in chrome or black finish.

Order No.	Description	Lumens	Pack	Std Carton
870W	oval, stripped leads	400	poly pack	6
M870W	oval, stripped leads	400	mfg. pack	50
M870W-BT2	oval, .180 bullets	400	mfg. pack	50
820-09	black oval bracket		poly pack	12
820-10	chrome oval bracket		poly pack	12
421-18	oval grommet		poly pack	12

**400 Lumens**

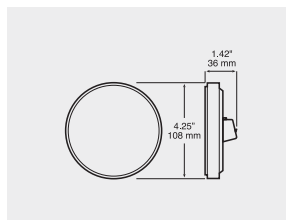

## 872W LumenX® LED Touch-On, Touch-Off Interior/Dome Light

**9** diodes **LumenX** **USA MADE** **HARD WIRED** **MV** Multi-Volt 12V & 24V **REG** Voltage Regulated

- Turns on and off with a simple touch of the lens surface.
- 400 lumen max output.
- Lens is welded to housing to form single unit.
- 9–32 volt operating range is compatible with 12V and 24V systems.
- Mounts in grommet or surface-mount bracket.
- Surface-mount bracket available in chrome or black finish.

Order No.	Description	Lumens	Pack	Std Carton
872W	round, stripped leads	400	poly pack	6
M872W	round, stripped leads	400	mfg. pack	50
M872W-BT2	round, .180 bullets	400	mfg. pack	50
817-09	black round bracket		poly pack	12
817-10	chrome round bracket		poly pack	12
426-18	round grommet		poly pack	12

STT  
TURN  
MARKER  
B-U/UTIL  
SPEC  
EMERG  
ECE  
MOUNT  
ELECT  
REFLECT  
ACCY  
MERCH  
TECH

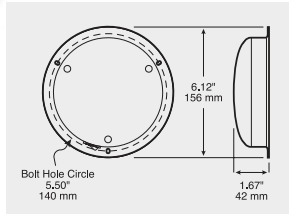

**380**

**Interior Dome/Utility Light**

- Surface-mount light perfect for dome or utility light applications.
- On/off rocker switch.
- White powder-coated metal housing.
- Polycarbonate lens is secured with three screws for easy bulb replacement.
- Includes two wires: .156 male bullet and .156 female plug.

Order No.	Description	Pack	Std Carton
M380S	white light w/ switch	mfg. pack	50
380-25C	clear repl. lens	poly pack	10
1141	replacement bulb		<i>reference only</i>



**382**

**Euro-Style Oval Porch/Utility Light With Switch**



- Includes rocker on/off switch.
- 382 features two 5.5" lead wires.
- Viz Pack includes both clear and amber lenses.
- Polycarbonate lens is secured with three screws.
- CSA approved.
- Plastic base for corrosion-free service.

Order No.	Description	Pack	Std Carton
V382S	amber/clear w/ switch	Viz Pack	6
M382C	clear w/ switch	mfg. pack	50
383-25C	clear repl. lens	poly pack	10
383-25A	amber repl. lens	poly pack	10
1141	replacement bulb		<i>reference only</i>



Viz Pack includes extra amber lens.

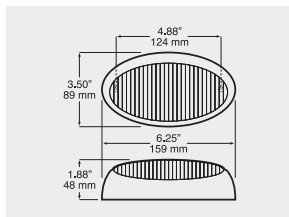

**384/385**

**Rectangular Porch/Utility Lights**



- Surface mount porch or utility light available with or without switch.
- Snap-in lens allows for easy bulb replacement.
- Contains separate ground wire.
- Viz Packs include both clear and amber lenses.
- 384 series has polar white base.
- 385 series has colonial white base.

Order No.	Description	Pack	Std Carton
V384	polar white kit w/o switch	Viz Pack	6
V384S	polar white kit w/ switch	Viz Pack	6
V385S	colonial white kit w/ switch	Viz Pack	6
M385S	colonial w/ switch, clear lens	mfg. pack	50
384-15A	amber repl. lens	poly pack	10
384-15C	clear repl. lens	poly pack	10
93	replacement bulb		<i>reference only</i>

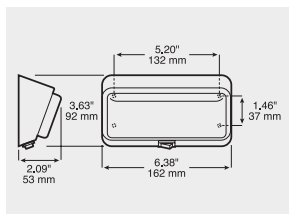

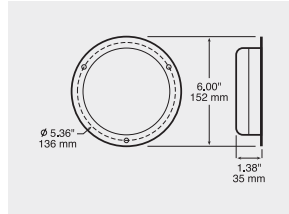

## 389

### Dome Light

- Durable 12-volt interior dome light with switch.
- For bright general illumination.
- Plastic translucent lens snaps securely onto base.
- Aluminum base for corrosion-free service.
- Surface mounts with single lead wire for electrical connection.
- Grounds through mounting screw.

Order No.	Description	Pack	Std Carton
389S	aluminum	poly pack	12
M389S	aluminum	mfg. pack	48
389-15C	replacement lens	poly pack	10
1141	replacement bulb		<i>reference only</i>

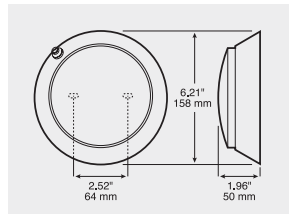

## 390

### Dome Light



- Durable 12-volt interior dome light with switch.
- For bright general illumination.
- Plastic translucent lens snaps securely onto base.
- Plastic base for corrosion-free service.
- Surface mounts and grounds through base.
- Single lead wire supplied for electrical connection.

Order No.	Description	Pack	Std Carton
V390S	plastic	Viz Pack	6
M390S	plastic	mfg. pack	48
1141	replacement bulb		<i>reference only</i>

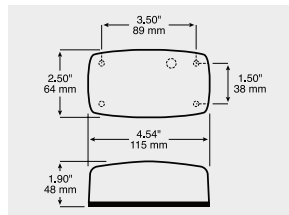

## 391

### Interior Light



- Polycarbonate 12-volt interior dome light with nylon switch.
- For bright general illumination.
- Metal base surface mounts with screws on 3 1/2" centers.
- Separate ground and lead wires supplied for electrical connection.

Order No.	Description	Pack	Std Carton
V391C	clear	Viz Pack	3
M391	clear	mfg. pack	48
391-25	replacement lens	mfg. pack	10
1141	replacement bulb		<i>reference only</i>

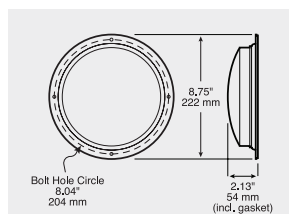

## 395

### Dome/Utility Light

- Interior or exterior, surface-mount, clear RV utility light.
- Stainless-steel housing and gasketed acrylic lens.
- Weather-resistant mounting gasket.
- CSA Approved.
- Separate 5.75" lead and ground wires for electrical connection.

Order No.	Description	Pack	Std Carton
M395C	clear	mfg. pack	25
700-15C	replacement lens	poly pack	10
1156	replacement bulb		<i>reference only</i>



701-491  
anti-flicker harness



RETAIL  
TWIN PACK  
V701KC-2

## 701C Great White® LED 7" PAR 56 Headlight



- 1100/1650 lumen output (low/high beam).
- Wider, more even pattern than halogen bulbs.
- Designed to last many times longer than a traditional sealed beam.
- Multivolt design is compatible with both 12V and 24V systems.
- Low power consumption — draws only 0.7–1.9 amps.
- DOT-legal; exceeds FMVSS-108 and CMVSS-108 requirements.
- Meets applicable SAE standards.
- Drop-in LED replacement for all PAR56 7-inch standard headlights, including popular H6014, H5024 and H6024 halogen sealed beams.
- 5400k–6400k color temperature closely matches natural daylight.
- UV- and impact-resistant, hard-coated polycarbonate lens
- Standard H4 3-blade terminals integrated directly into the heavy-duty cast alloy rear housing.
- Requires 701-491 anti-flicker harness for use on CANBUS-equipped vehicles, including '07 and newer Jeep Wrangler.
- Does not function as a daytime running light (DRL).
- V701KC-2 Kit includes two 701C headlights & two 701-491 anti-flicker harnesses.
- See ECE version on page 158 for markets with left-hand traffic.
- IP66 ingress rating.

Order No.	Description	Pack	Std Carton
V701C	LED 7" PAR56 repl.	Retail Box	1
V701KC-2	<b>KIT</b> LED 7" PAR56 Twin Pack	Viz Pack Box	2*
701C	DOT-compliant	box	1
M701C	DOT-compliant	mfg. pack	4
701-491	anti-flicker harness	poly pack	1

\*Two kits of two lights each per master carton

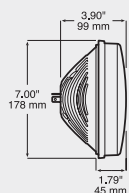

## 702C/703C Great White® LED Rectangular Quad Headlights



- 702C is an SAE Type 2A1 low beam w/ 4-diode, single-chip assembly.
- 703C is an SAE Type 1A1 high beam w/ 6 diodes.
- Greater vibration & shock resistance for longest available service life.
- Multivolt design is compatible with both 12V and 24V systems.
- Heavy-duty polycarbonate/cast alloy housing.
- UV & impact resistant, hard-coated polycarbonate lens.
- Vacuum metallized reflector.
- 800 (702C) & 1000 (703C) source lumens.
- Low power draw: 10.25 watts (702C) & 17 watts (703C).
- DOT-legal; exceeds FMVSS-108 and CMVSS-108 requirements.
- 5200k ~6000k (702C) & 5200k ~6300k (703C) color temperature.
- 3.5", 18 gauge, hardwired leads terminated w/ standard H4 terminals.
- IP66 ingress rating.

Order No.	Description	Pack	Std Carton
V702C	4"x6" low beam	Retail Box	2
V703C	4"x6" high beam	Retail Box	2
702C	4"x6" low beam	box	1
703C	4"x6" high beam	box	1

\*Physical configuration and electrical compatibility does not guarantee legal compliance in OE or retrofit applications. Refer to vehicle manufacturers' specifications and government and SAE documentation regarding headlight requirements and aiming standards. The 702C low-beam function headlight is designed only for use as part of a four-lamp integrated system of the type shown above. It is not designed or sold as a replacement for a dual function (high/low beam) headlight. Federal law requires that horizontal adjustment be disabled for the 702C.

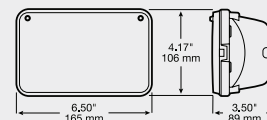

# LED HEADLIGHTS



## 705C Great White® LED Rectangular Headlight



- SAE Type 2B1 lamp (one rectangular high-low beam lamp per side)
- 800 / 1600 lumen output (low / high beam).
- Wider, more even pattern than halogen bulbs.
- Designed to last many times longer than a traditional sealed beam.
- Multivolt design is compatible with both 12V and 24V systems.
- Low power consumption — draws only 0.51–2.23 amps.
- DOT-legal; exceeds FMVSS-108 and CMVSS-108 requirements.
- Meets applicable SAE standards.
- 5200k~6000k color temperature.
- Heavy-duty black polycarbonate/cast alloy housing.
- UV- and impact-resistant, hard-coated polycarbonate lens.
- -30° C to 50° C (-22° F to 122° F) operating temperature range.
- Hardwired w/ standard H4 3-blade connector.
- IP67 ingress rating.

Order No.	Description	Pack	Std Carton
V705C	5"x7" high & low beam	Retail Box	2
705C	5"x7" high & low beam	box	1

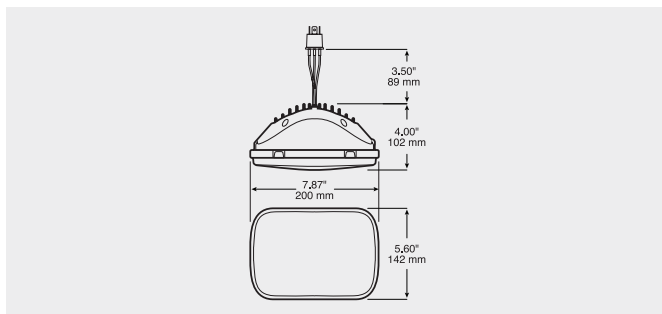

# SPECIALTY LIGHTING

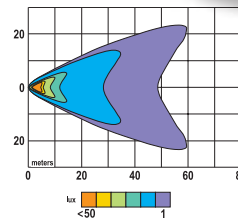

Cast aluminum housing

## 711 Great White® LED PAR 36 LED Replacement Beam



- High-output Great White® diodes for a bright general illumination.
- Fits all standard Par 36 incandescent sealed beam applications.
- Impact-resistant polycarbonate lens.
- Cast aluminum body with matte black finish.
- Compatible with both 12 and 24-volt systems.
- Self-service visual packaging.
- See pedestal-mount 908S version on page 127.

Order No.	Description	Pack	Std Carton
V711	round	Viz-Pack	6
711	round	mfg. pack	20

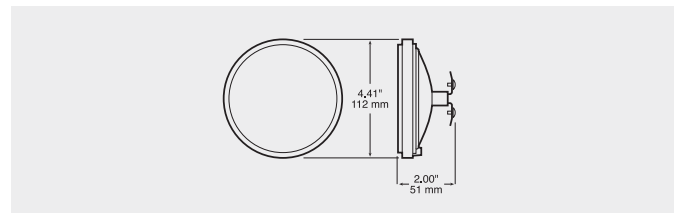

- STT
- TURN
- MARKER
- B-U/UTIL
- SPEC
- EMERG
- ECE
- MOUNT
- ELECT
- REFLECT
- ACCY
- MERCH
- TECH



**817-9 LumenX® LED  
4" Round Work Light**



- New white diodes behind clear lens.
- Available in 450 lumen & 800 lumen versions.
- Advanced optics fully illuminate lens.
- Flood pattern for broad illumination.
- Also suitable for dome or utility light.
- Regulated design provides voltage protection and consistent light output over a wide voltage range.
- Skirted weld joint provides added protection against road and weather conditions.
- 817 series has 9–32 volt operating range. 800 series is compatible with 12 volt systems only.
- 800 series draws 0.65A @ 14V.
- 817/818 series draws 0.29A @ 12V, 0.22A @ 24V.
- M800W-9 & M817W-9 require grommet or surface-mount bracket.
- M800WF-9 M818W-9 are equipped with integral mounting flange.

Order No.	Description	Pack	Std Carton
800W-9	grommet mnt, 800 lumen, 12V	poly pack	6
800WF-9	flange mnt, 800 lumen, 12V	poly pack	6
817W-9	grommet mnt, 450 lumen, MV	poly pack	6
818W-9	flange mount, 450 lumen, MV	poly pack	6
M800W-9	grommet mnt, 800 lumen, 12V	mfg. pack	50
M800WF-9	flange mnt, 800 lumen, 12V	mfg. pack	50
M817W-9	grommet mnt, 450 lumen, MV	mfg. pack	50
M818W-9	flange mount, 450 lumen, MV	mfg. pack	50
417-1	surface mount bracket	mfg. pack	40
426-18	grommet	poly pack	12
B426-18	grommet	mfg. pack	100
417-48	hardshell plug	poly pack	6
B417-48	hardshell plug	mfg. pack	100
817-48	molded plug	poly pack	12
B817-48	molded plug	mfg. pack	100

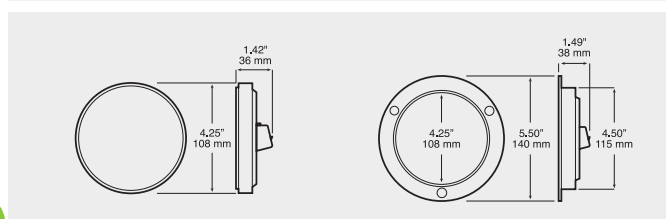

**901 Great White® LED  
2" Round Mini Work Light**



- High-output single white diode for a bright, narrow spot beam pattern.
- Impact-resistant polycarbonate lens.
- Die-cast aluminum body with matte black finish.
- Heat dissipating fins for durability and longevity.
- High vibration resistance and low amp draw.
- Compatible with both 12 and 24-volt systems.
- 9–48 VDC operating range.
- Reverse voltage protection.
- Draws 1.3A @ 12V, 0.65 @ 24V.
- 2-Conductor black PVC jacketed harness 20 GA GPT.
- IP68 rated.
- Stainless steel mounting hardware.
- EMC certified.

Order No.	Description	Pack	Std Carton
V901-MV	round	Viz-Pack	4
901-MV	round	box	1

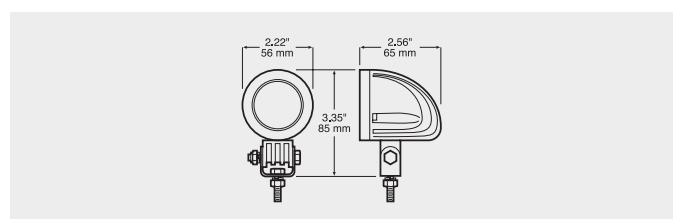
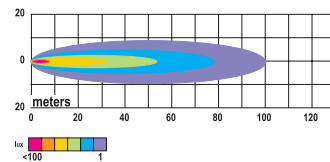



**2000 Lumens**

## 903 Great White® LED 3" x 5" Rectangular Work Light



**COMMERCIAL GRADE**

- Bright, even flood pattern.
- Extra-rugged, commercial-grade construction.
- Impact-resistant polycarbonate lens.
- Die-cast aluminum body with black finish.
- Heat dissipating fins for durability and longevity.
- High vibration resistance and low amp draw.
- Compatible with both 12 and 24-volt systems.
- 9–32 VDC operating range.
- Reverse voltage protection.
- Draws 2.65A @ 12V, 1.0A @ 24V.
- 2-Conductor black PVC jacketed harness.
- IP67 rated.
- Stainless steel mounting hardware.
- Certified to ECE Reg 10.

Order No.	Description	Pack	Std Carton
903-MV	rectangular, stripped leads	box	1
903-MV-PKD	rectangular, hardshell connector	box	1

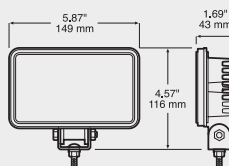
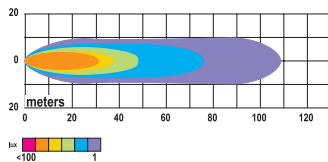

**750 Lumens**

## 904 Great White® LED 3" x 3" Square Work Light



- Bright, even flood pattern.
- Impact-resistant polycarbonate lens.
- Die-cast aluminum body with matte black finish.
- Heat dissipating fins for durability and longevity.
- High vibration resistance and low amp draw.
- Compatible with both 12 and 24-volt systems.
- 9–36 VDC operating range.
- Reverse voltage protection.
- Draws 0.98A @ 12V, 0.43A @ 24V.
- 2-Conductor black PVC jacketed harness 20 GA GPT.
- Operating temperature: -40° – +65° C.
- Color temperature: 6300k.
- Certified to ECE Reg 10.
- IP67 rated.
- Stainless steel mounting hardware.

Order No.	Description	Pack	Std Carton
V904-MV	square	Viz-Pack	4
904-MV	square	box	1
904-MV-BT2	square, .180 bullets	box	1

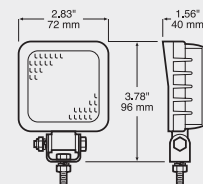
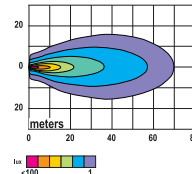



**500 Lumens**



Available with integrated AMP-compatible receptacle on rear

**905 LED**  
**3" x 3" Pedestal-Mount Work Light**



- Low profile, light-weight design is just 1.39" thin.
- Optimized work light beam pattern for even general area illumination.
- Reinforced mounting insert and stainless steel mounting hardware.
- Rugged textured polymer housing and lens.
- High vibration resistance and low amp draw.
- Stainless steel mounting hardware.
- 9-32 volt operating range.
- IP67 ingress rating
- Draws 0.40 amps @12V, 0.21 amps @24V.
- 905-MV has two hardwired, stripped leads.
- M905-MV-AMP has integrated AMP-compatible receptacle built into rear housing.
- M905-MV-BT2 has two hardwired leads with .180 bullet connectors.

Order No.	Description	Pack	Std Carton
V905-MV	stripped leads	Viz Pack	3
905-MV	stripped leads	poly pack	6
M905-MV	stripped leads	mfg. pack	60
M905-MV-AMP	AMP-compatible receptacle	mfg. pack	60
M905-MV-BT2	.180 bullets	mfg. pack	60

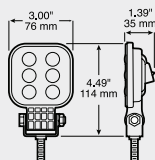
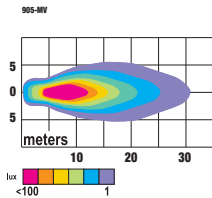

**1000 Lumens**



Available with integrated AMP-compatible receptacle on rear

**906 LED**  
**3" x 5" Pedestal-Mount Work Light**



- Low profile, light-weight design is just 1.39" thin.
- Optimized work light beam pattern for even general area illumination.
- Reinforced mounting insert and stainless steel mounting hardware.
- Rugged textured polymer housing and lens.
- High vibration resistance and low amp draw.
- Stainless steel mounting hardware.
- 9-32 volt operating range.
- IP67 ingress rating
- Draws 0.81 amps @12V, 0.41 amps @24V.
- 906-MV has two hardwired, stripped leads.
- M906-MV-AMP has integrated AMP-compatible receptacle built into rear housing.
- M906-MV-BT2 has two hardwired leads with .180 bullet connectors.

Order No.	Description	Pack	Std Carton
V906-MV	stripped leads	Viz Pack	3
906-MV	stripped leads	poly pack	6
M906-MV	stripped leads	mfg. pack	50
M906-MV-AMP	AMP-compatible receptacle	mfg. pack	50
M906-MV-BT2	.180 bullets	mfg. pack	50

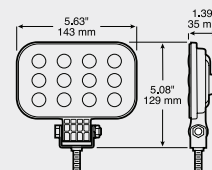
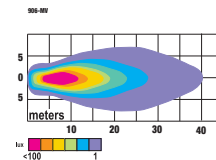



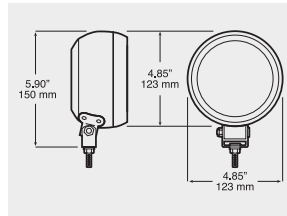

## 907/908 LumenX® LED 4" Round Work Light



- Extremely even, flood pattern for broad illumination.
- Also suitable for use as a utility light.
- Sealed LED work light installed in rubber housing with lead wires.
- Available in multi-volt and 12 volt version.
- 908 draws 0.65A @ 14V.
- 907-MV draws 0.29A @ 12V, 0.22A @ 24V.

Order No.	Description	Pack	Std Carton
V908	800 lumen, 12V	Viz Pack	6
907	450 lumen, multi-volt	poly pack	6
M907-MV	450 lumen, multi-volt	mfg. pack	24
M908	800 lumen, 12V	mfg. pack	24

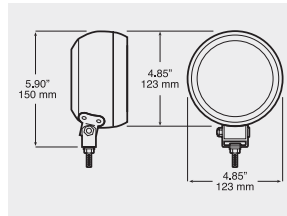
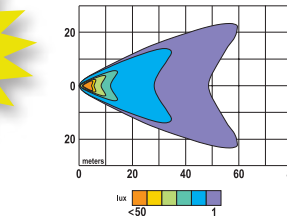

## 908S Great White® LED 4" Round Work Light



Weatherproof, push-on/  
push-off switch

- High-output Great White® diodes for a bright general illumination.
- Convenient on-off switch located on rear of housing.
- Uses 711 LED sealed beam installed in rubber housing.
- Two lead wires terminated with .180 bullets.
- Multi-volt design is compatible with both 12-volt and 24-volt systems.
- Draws 1.45A @ 12V, 0.72A @ 24V.

Order No.	Description	Pack	Std Carton
M908S-MV-BT2	900 lumen, multi-volt, with switch	mfg. pack	24

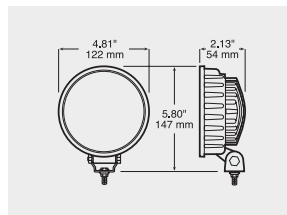
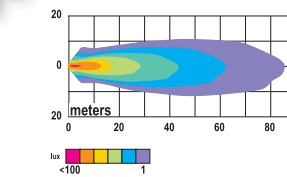

## 911 Great White® LED Pedestal-Mount Work Light



**COMMERCIAL  
GRADE**

- High-output Great White® diodes for a bright, even, round pattern.
- Extra-rugged, commercial-grade construction.
- Cast aluminum body with heat-dissipating fins for durability and longevity.
- High vibration resistance and low amp draw.
- 9-32 volt operating range.
- Draws 1.65A @ 12.8V, 0.78A @ 28V.
- Comes complete with stainless steel mounting hardware.

Order No.	Description	Pack	Std Carton
911-MV	round	box	1
911-MV-PKD	w/ hardshell connector	box	1
911-MV-BT2	w/ .180 bullets	box	1

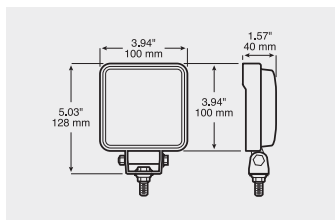
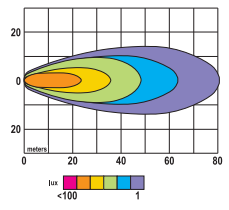

**910 Great White® LED Pedestal-Mount Work Light**

9 diodes **VIZ PACK** **HARD WIRED** **MV Multi-Volt 12V & 24V** **REG Voltage Regulated**

- High-output Great White® diodes for a bright, even, flood pattern.
- Die-cast aluminum body with heat-dissipating fins for durability & longevity.
- High vibration resistance.
- 10–30 volt operating range.
- Draws 1.2A @ 13.5V, 0.59A @ 28V.
- Operating temperature: -40° – +65° C.
- Comes complete with stainless steel mounting hardware.
- IP67/IP69K Rated.
- RoHS compliant.
- Certified to ECE Reg 10.

Order No.	Description	Pack	Std Carton
V910-MV	stripped leads	Viz-Pack	4
910-MV	stripped leads	box	1
910-MV-BT2	w/ .180 bullets	box	1
910-MV-PKD	w/hardshell connector	box	1

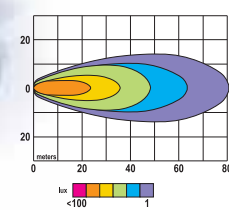
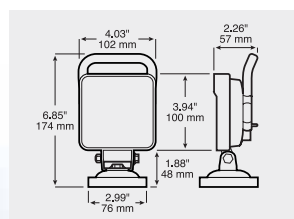

**910M Great White® LED Magnetic-Mount Work Light with Switch**

9 diodes **VIZ PACK** **HARD WIRED** **MV Multi-Volt 12V & 24V** **REG Voltage Regulated** **magnetic**

- Same great features as 910-MV, but in a magnetic, temporary-mount light.
- Strong magnetic-mount base has no-scratch, rubberized face.
- Rear-mounted on/off toggle switch.
- 8-foot, quick-disconnect coil cord with 12V accessory plug.
- Handy grab handle makes carrying and repositioning light easy.



Order No.	Description	Pack	Std Carton
V910M-MV	stripped leads	Viz-Pack	3
910M-MV	stripped leads	box	1

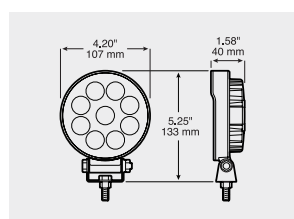
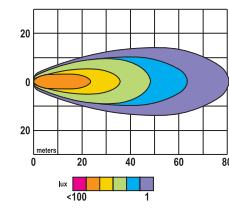

**921 Great White® LED Pedestal-Mount Work Light**

9 diodes **VIZ PACK** **HARD WIRED** **MV Multi-Volt 12V & 24V** **REG Voltage Regulated**

- High-output Great White® diodes for a bright, even, flood pattern.
- Die-cast aluminum body with heat-dissipating fins for durability & longevity.
- High vibration resistance.
- 10–30 volt operating range.
- Draws 1.2A @ 13.5V, 0.59A @ 28V.
- Operating temperature: -40° – +65° C.
- Comes complete with stainless steel mounting hardware.
- IP67/IP69K Rated.
- RoHS compliant.
- Certified to ECE Reg 10.

Order No.	Description	Pack	Std Carton
V921-MV	stripped leads	Viz-Pack	4
921-MV	stripped leads	box	1
921-MV-BT2	20" leads, .180 bullets	box	1



**900 Lumens**



**1400 Lumens**

## 912 Great White® LED 3" Round Work Light



- High-output Great White® diodes for a bright, even flood pattern.
- Impact-resistant polycarbonate lens.
- Cast aluminum body with heat-dissipating fins for durability and longevity.
- High vibration resistance and low amp draw.
- 9–32 VDC operating range is compatible with 12 and 24-volt systems.
- Reverse voltage protection.
- Draws 1.11A @ 12V, 0.61A @ 24V.
- 2-Conductor black PVC jacketed harness 18 GA GPT.
- Operating temperature: -40° – +65° C.
- Color temperature: 6500k.
- IP67 rated.
- Stainless steel mounting hardware.

Order No.	Description	Pack	Std Carton
V912-MV	round	Viz Pack	4
912-MV	round	box	1

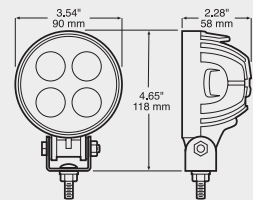
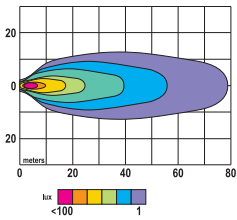

## 913 Great White® LED 3" x 3" Compact Work Light



- High-output Great White® diodes for a bright, even flood pattern..
- Cast aluminum body and Impact-resistant polycarbonate lens are IP67 rated.
- Heat-dissipating fins for durability and longevity.
- High vibration resistance and low amp draw.
- 9–32 VDC operating range is compatible with 12 and 24-volt systems.
- Reverse voltage protection.
- Draws 1.3A @ 12V, 0.65A @ 24V.
- 2-Conductor black PVC jacketed harness 18 GA GPT.
- Operating temperature: -40° – +65° C.
- Color temperature: 6500k.
- Certified to ECE Reg 10.
- Stainless steel mounting hardware.

Order No.	Description	Pack	Std Carton
V913-MV	square	Viz-Pack	4
913-MV	square	box	1
913MV-AMP	square w/ AMP connection	box	1
913MV-BT2	square w/ .180 bullets	box	1

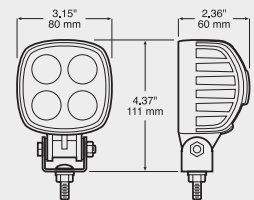
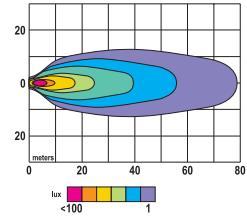

STT  
TURN  
MARKER  
B-U/UTIL  
SPEC  
EMERG  
ECE  
MOUNT  
ELECT  
REFLECT  
ACCY  
MERCH  
TECH

**3200 Lumens**

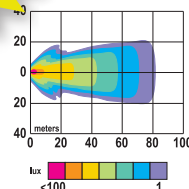
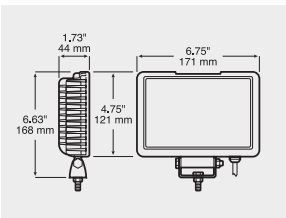
1.73" 44 mm  
6.63" 168 mm  
4.75" 121 mm  
6.75" 171 mm

**915 Great White® LED  
5" x 7" Rectangular Work Light**



- High-output Great White® diodes for a bright, even flood pattern.
- Impact-resistant polycarbonate lens.
- Cast aluminum body with heat-dissipating fins for durability and longevity.
- High vibration resistance and low amp draw.
- 9–32 VDC operating range is compatible with 12 & 24-volt systems.
- Reverse voltage protection.
- Draws 3.2A @ 12V, 1.6A @ 24V.
- 2-Conductor black PVC jacketed harness.
- Color temperature: 6000k.
- CE & EMC Certified.
- IP67 Rated.
- Stainless steel mounting hardware.

Order No.	Description	Pack	Std Carton
915-MV	rectangular	box	1

**450 or 800 Lumens**



5.20" 132 mm  
6.20" 157 mm  
8.60" 218 mm  
2.40" 61 mm  
4.00" 102 mm  
5.00" 127 mm

**916/918 LumenX® LED  
Swiveling Work Light**



- 916S features 817W-9 light, 918S features 800W-9 light
- Rugged, cast aluminum housing with durable gray powder-coat finish.
- Mounting arm with two 360° joints swivels to point light in any direction.
- High vibration resistance.
- 918S draws 0.65A @ 14V.
- 916S draws 0.29A @ 12V, 0.22A @ 24V.
- Convenient push-button switch.
- Two lead wires.

Order No.	Description	Pack	Std Carton
916S	450 lumen, multi-volt, stripped leads	box	1
916S-JAMP	450 lumen, multi-volt, jacketed AMP	box	1
918S	800 lumen, 12V, stripped leads	box	1

**1900 Lumens**





5.96" 151 mm  
3.15" 80 mm  
4.72" 120 mm  
4.33" 110 mm  
1.50" 38 mm

**919 Great White® LED  
3.25" x 4.75" Work Light**



- High-output Great White® diodes for a bright, even, wide spot pattern.
- Die-cast aluminum body with matte black finish.
- Swiveling head can be mounted horizontally or vertically.
- 10–40 VDC operating range is compatible with 12 & 24-volt systems.
- Operating temperature: -30° – +50° C.
- Operating current: 1.64A @ 12VDC, 0.83A @ 24VDC.
- Stainless steel mounting hardware.
- RoHS compliant.
- IP67/IP69K rated.
- Certified to ECE Reg 10.

Order No.	Description	Pack	Std Carton
V919-MV	oval	Viz Pack	5
919-MV	oval	box	1



**2520 Lumens**

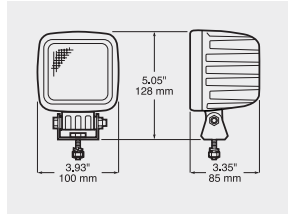

**928 Great White® LED  
3" x 3" Square Work Light**



- High-output Great White® diodes for a bright, even flood pattern.
- 10–30 VDC operating range.
- Draws 2.15A @ 12V, 1.03A @ 24V.
- Impact-resistant polycarbonate lens.
- Die-cast aluminum body with matte black finish.
- Operating temperature: -30° – +50° C.
- Stainless steel mounting hardware.
- IP67 and IP69K Rated.
- RoHS compliant.
- Certified to ECE Reg 10.

Order No.	Description	Pack	Std Carton
928-MV	square	box	1



**Perfect for FORK LIFTS**

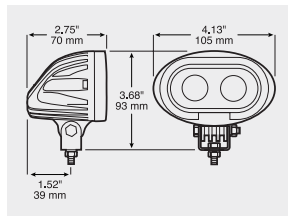

**920B-MV Great White® LED  
Blue Pedestrian Warning Light**



- Two 5 watt blue diodes for a bright spot pattern.
- Impact-resistant polycarbonate lens.
- Die-cast aluminum body with matte black finish.
- Heat dissipating fins for durability and longevity.
- High vibration resistance and low amp draw.
- Operating voltage: 12-48V DC
- Operating current: 0.6A @ 12.8VDC, 0.3A @ 28VDC.
- PVC jacketed, partially stripped, 17.75" (450mm) lead wires.
- Operating temperature range: -40°F - +149°F (-40°C - +65°C).
- IP67 rated.
- Stainless steel mounting hardware.

Order No.	Description	Pack	Std Carton
920B-MV	blue, oval	box	1



LEDs light up both RED & GREEN

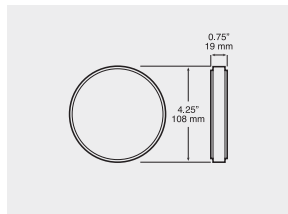

**1217G-R LED  
Traffic Indicator / Loading Dock Light**



- Dual-color diodes provide red and green indicators in a single lens.
- Ideal for loading bays, car parks, barriers and gates.
- Includes 4 meter co-extruded three-core cable.
- 18–28 volt operating range.
- Individually boxed.
- IP67 ingress protection rating.
- Installation requires 426-18 grommet or 417-1 bracket, available separately.

Order No.	Description	Pack	Std Carton
1217G-R	red/green bi-color	box	30
417-1	surface mount bracket	mfg. pack	40
426-18	grommet	poly pack	12
B426-18	grommet	mfg. pack	100



**DOUBLE  
ROW**

**19,300  
Lumens**



**SINGLE  
ROW**

**13,300  
Lumens**

**930 Nightwatcher® LED  
39" Rectangular Light Bar**



- Rugged, extruded aluminum housing with die-cast end caps.
- Thick, scratch-resistant polycarbonate lens.
- Powder-coated black finish.
- Infinitely adjustable mounting pedestal locations.
- Flood beam pattern.
- 6000K–6500K daylight color temperature.
- 10–30 volt operating range.
- Draws 15A @ 13.5V, 6.6A @ 28V.
- IP66 ingress protection rating.
- Includes all mounting hardware.
- 18" sheathed leads.
- Includes fuse holder, 20 amp ATC fuse, and butt connectors for easy wiring.

Order No.	Description	Pack	Std Carton
930-MV	double row flood	box	1

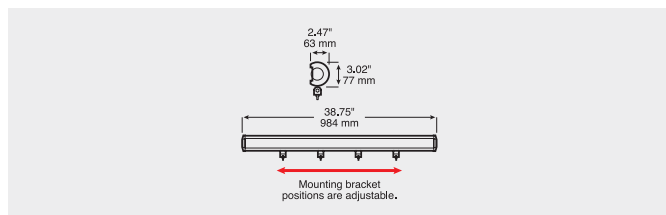

**931 Nightwatcher® LED  
39" Rectangular Light Bar**



- Rugged, extruded aluminum housing with die-cast end caps.
- Thick, scratch-resistant polycarbonate lens.
- Powder-coated black finish.
- Infinitely adjustable mounting pedestal locations.
- 60° flood beam pattern.
- 6000K–6500K daylight color temperature.
- 10–30 volt operating range.
- Draws 11.6A @ 13.5V, 5.2A @ 28V.
- IP66 ingress protection rating.
- Includes all mounting hardware.
- 18" sheathed leads with Deutsch style connector (DT04-2P).
- Remove connector plug for custom termination option.

Order No.	Description	Pack	Std Carton
931-MV	single row flood	box	1

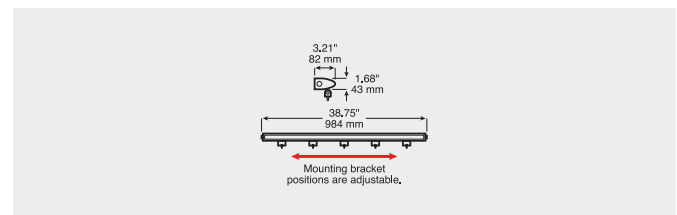

# LED LIGHT BARS

# SPECIALTY LIGHTING



**SINGLE ROW**

**3000 Lumens**

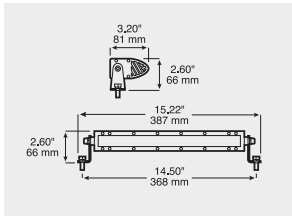

## 932 Nightwatcher® LED 14" Rectangular Light Bar

**12** diodes **VIZ PACK** **HARD WIRED** **MV** Multi-Volt 12V & 24V **REG** Voltage Regulated

- Combination beam with 60° flood beam and 30° spot beam patterns.
- 6000–6500K color temperature.
- 9–32 VDC operating range.
- Draws 3.54A @ 13.5V, 1.77A @ 28V.
- Rugged extruded aluminum housing.
- Powder-coated black finish.
- 18" sheathed leads with Deutsch-style connector.
- Female pigtail included for custom installation.
- Includes side-mount brackets and hardware.
- IP68 ingress rating.
- Attractive, full-color retail box with window.

Order No.	Description	Pack	Std Carton
V932-MV	single row flood/spot	Viz Pack	1



**DOUBLE ROW**

**3600 Lumens**

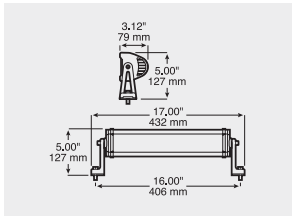

## 933 Nightwatcher® LED 14" Rectangular Light Bar

**24** diodes **VIZ PACK** **HARD WIRED** **MV** Multi-Volt 12V & 24V **REG** Voltage Regulated

- Combination beam with 60° flood beam and 30° spot beam patterns.
- 6000–6500K color temperature.
- 10–30 VDC operating range.
- Draws 3.36A @ 13.5V, 1.53A @ 28V.
- Rugged extruded aluminum housing.
- Powder-coated black finish.
- Thick, scratch-resistant polycarbonate lens.
- 18" sheathed leads with Deutsch-style connector.
- Female pigtail included for custom installation.
- Includes side-mount brackets and hardware.
- IP68 ingress rating.
- Attractive, full-color retail box with window.

Order No.	Description	Pack	Std Carton
V933-MV	double row flood/spot	Viz Pack	1



**DOUBLE ROW**

**6000 Lumens**

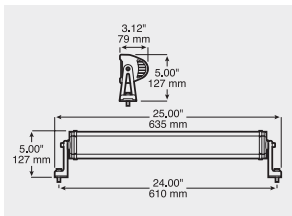

## 934 Nightwatcher® LED 22" Rectangular Light Bar

**40** diodes **VIZ PACK** **HARD WIRED** **MV** Multi-Volt 12V & 24V **REG** Voltage Regulated

- Combination beam with 60° flood beam and 30° spot beam patterns.
- 6000–6500K color temperature.
- 10–30 VDC operating range.
- Draws 7.98A @ 13.5V, 3.14A @ 28V.
- Rugged extruded aluminum housing.
- Powder-coated black finish.
- Thick, scratch-resistant polycarbonate lens.
- 18" sheathed leads with Deutsch-style connector.
- Female pigtail included for custom installation.
- Includes side-mount brackets and hardware.
- IP68 ingress rating.
- Attractive, full-color retail box with window.

Order No.	Description	Pack	Std Carton
V934-MV	double row flood/spot	Viz Pack	1

- STT
- TURN
- MARKER
- B-U/UTIL
- SPEC
- EMERG
- ECE
- MOUNT
- ELECT
- REFLECT
- ACCY
- MERCH
- TECH

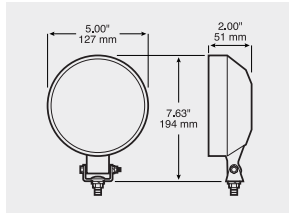

408

Tractor/Utility Light



- Tractor or utility light with trapezoid beam pattern.
- Replaceable 55W H3 halogen bulb.
- Slim housing fits into tight areas.
- 2370 candelas, 880 lumens.
- Black plastic housing and hardened glass lens.
- Adjustable mounting hardware.
- Separate 8" lead and ground wires for electrical connection.

Order No.	Description	Pack	Std Carton
V408	trapezoid	Viz Pack	6
M408	trapezoid	mfg. pack	36
VH550	replacement bulb	Viz Pack	12

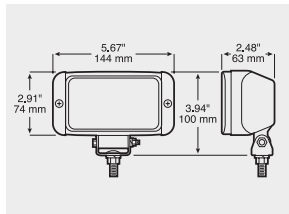

502

3" x 5" Tractor/Utility Light



- Low-profile, rectangular lamp functions as tractor or utility light.
- Available in both trapezoid (HT) and flood (HF) beam patterns.
- Replaceable 55W H3 halogen bulb.
- Flood version outputs 2190 candelas, 949 lumens.
- Trapezoid version outputs 6190 candelas, 949 lumens.
- Black plastic housing
- Adjustable black zinc plated steel mounting hardware.
- Self-service Viz Pack packaging.

Order No.	Description	Pack	Std Carton
V502HF	flood	Viz Pack	3
V502HT	trapezoid	Viz Pack	3
M502HF	flood	mfg. pack	12
VH550	replacement bulb	Viz Pack	12

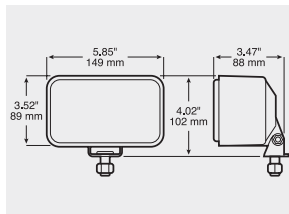

503

3" x 5" Tractor & Work Light



- Heavy-duty lamp with 3" x 5" lens.
- Functions as tractor or general work light.
- Available in both trapezoid (HT) and flood (HF) beam patterns.
- Replaceable 55W H3 halogen bulb.
- 4060 candelas, 870 lumens (flood version 780 lumens).
- Polycarbonate housing.
- Black-plated mounting bracket for corrosion-free service.
- Self-service Viz Pack packaging.

Order No.	Description	Pack	Std Carton
V503HF	flood	Viz Pack	3
V503HT	trapezoid	Viz Pack	3
M503HF	flood	mfg. pack	12
VH550	replacement bulb	Viz Pack	12



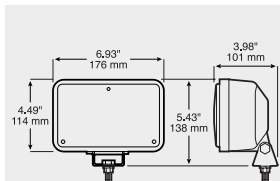

504

## 4" x 6" Tractor / Work Light



- Heavy-duty tractor or general work light with 4" x 6" lens.
- Available in both trapezoid (HT) and flood (HF) beam patterns.
- Replaceable 55W H3 halogen bulb.
- Flood version outputs 3800 candelas, 813 lumens.
- Trapezoid version outputs 3120 candelas, 860 lumens.
- Nylon housing and black-plated hardware for corrosion resistance.
- Self-service Viz Pack packaging.

Order No.	Description	Pack	Std Carton
V504HF	flood	Viz Pack	3
V504HT	trapezoid	Viz Pack	3
VH550	replacement bulb	Viz Pack	12

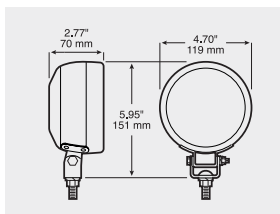

507

## PAR 36 Rubber Tractor Light



- PVC molded housing cushions lamp from shock and vibration.
- Replaceable, flush-mount, par 36 sealed beam.
- Available in both trapezoid and flood beam patterns.
- 10" lead wire exits through back of housing, grounds through mounting stud.
- 507S includes push-button on/off switch on back of housing and .180 bullet terminal on lead.
- Universal 5/16" mounting stud and adjustable zinc-plated bracket allow mounting in any position.
- Accepts standard 4411 (trap. 12V), 4511 (trap. 6V), H7610 (halogen trap.) or H7614 (halogen flood) bulb.
- See 907 LED version on page 127.

Order No.	Description	Pack	Std Carton
V507	trapezoid	Viz Pack	3
507	trapezoid	poly pack	12
M507	trapezoid	mfg. pack	24
M507S	trapezoid, with on/off switch	mfg. pack	24
507LU	housing only	poly pack	12
4411	replacement bulb (12v trapezoid)	<i>reference only</i>	

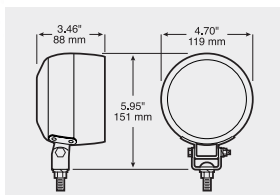

508

## PAR 36 Rubber Tractor Light



- Same quality design as the 507 series with recessed sealed beam.
- PVC hood reduces glare and provides added protection.
- Trapezoidal beam pattern.
- Accepts standard 4411 (trap. 12V), 4511 (trap. 6V), H7610 (halogen trap.) or H7614 (halogen flood) bulb.

Order No.	Description	Pack	Std Carton
V508	trapezoid	Viz Pack	6
M508	trapezoid	mfg. pack	16
4411	replacement bulb	<i>reference only</i>	

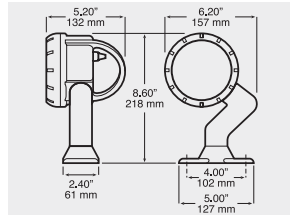

516

Heavy-Duty Swiveling Trapezoidal Work Light



- PAR 36 sealed beam work lamp.
- Trapezoidal pattern.
- Mounting arm with two 360° joints swivels to point light in any direction.
- Rugged cast aluminum housing with gray powder-coat finish.
- Convenient rubber-covered on-off switch and integrated handle.
- Uses 4411 trapezoidal sealed beam.
- Also available in LED version. See 916S and 918S on page 130.

Order No.	Description	Pack	Std Carton
516S	swivel housing	box	1

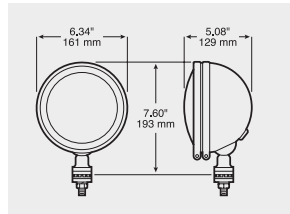

530 Nightwatcher® LX  
6" Round Off-Road Light



- 6" light produces over 250,000 candle power.
- Durable steel housing finished in black E-coat for long-lasting service.
- Aluminum-coated metal reflector.
- Hardened-glass lens.
- H3 100-watt halogen bulb.
- Armored cables.
- Universal swiveling, rubber cushioned mounting bracket.
- For off-road use only.

Order No.	Description	Pack	Std Carton
V530	black	Viz Pack	6
VH549	replacement bulb	Viz Pack	12

505 BladeLights®  
Snow Plow Light Kit

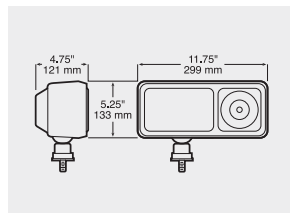

- Head light and turn signal kit for snow removal vehicles.
- Includes high and low beam function.
- Low-profile housing.
- Easy-to-replace sealed halogen beam and turn signal bulb.
- 1/2" diameter, adjustable-ball mounting stud.
- Meets FMVSS 108 requirements.
- Kits include two lights, wiring, switch, mounting hardware, and easy-to-follow instructions.
- 24" lead wires.
- Packaged in bright, four-color display box.

Order No.	Description	Pack	Std Carton
505K	<b>KIT</b> snow plow light kit	box	1
H6545	replacement sealed beam		reference only
2357	replacement bulb		reference only

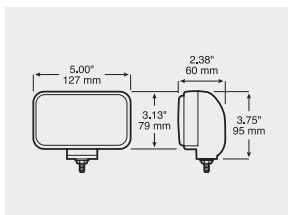

## 517 Nightwatcher® LX Mini Halogen Driving/Docking Light

- Powerful 55-watt, halogen driving or docking light.
- Black housing.
- Precision-cast, hardened-glass lens.
- Steel reflector with bright chrome plating.
- Stainless steel mounting hardware and bezel screws.
- Wiring kit sold separately.

Order No.	Description	Pack	Std Carton
M517S	black	mfg. pack	30
V520-10	wiring kit	Viz Pack	12
VH550	replacement bulb	Viz Pack	12

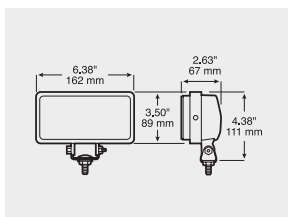

## 525 Nightwatcher® LX Halogen Docking Light



- Powerful 55-watt, halogen docking light.
- Black housing.
- Precision-cast, hardened-glass lens.
- Vaporized aluminum reflector.
- Viz Pack kit includes two lamps, wiring, connectors, fuse, rocker switch, and installation instructions.
- M525S and V525S-2 include stainless-steel mounting hardware and bezel screws.
- Lens and reflector assembly may be reversed for optional inverted mounting.

Order No.	Description	Pack	Std Carton
V525S-2	<b>KIT</b> kit w/ 1 1/2" SS bolt	Viz Pack	3
M525	1" bolt	mfg. pack	30
VH550	replacement bulb	Viz Pack	12

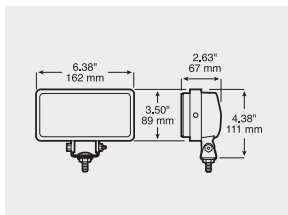

## 526 Nightwatcher® LX Chrome Clear Driving Light

- Powerful 55-watt, halogen driving light.
- Chrome plated steel housing.
- Precision-cast, hardened-glass lens.
- Vaporized aluminum reflector.
- Universal mounting bracket.
- Wiring kit sold separately.

Order No.	Description	Pack	Std Carton
M526	clear driving	mfg. pack	30
V520-10	wiring kit	Viz Pack	12

STT

TURN

MARKER

B-U/UTIL

SPEC

EMERG

ECE

MOUNT

ELECT

REFLECT

ACCY

MERCH

TECH

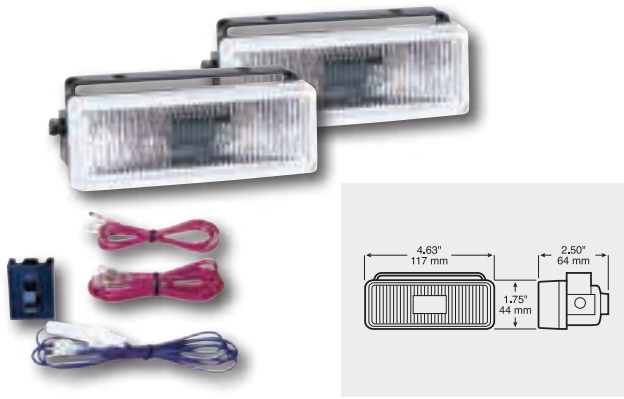

**557 Nightwatcher® LX  
Ultra-Slim Clear Fog Light**

- Attractive, low-profile clear fog light provides maximum road clearance.
- 55-watt halogen bulb.
- Black-finished aluminum diecast housing.
- Hardened-glass lens.
- Mounts above or below bumper.
- Screws or double-sided tape for installation on any surface.
- Kit contains two lights, rocker switch, wiring, and installation instructions.

Order No.	Description	Pack	Std Carton
557-2	<b>KIT</b> clear fog light kit	box pack	20
VH550	replacement bulb	Viz Pack	12

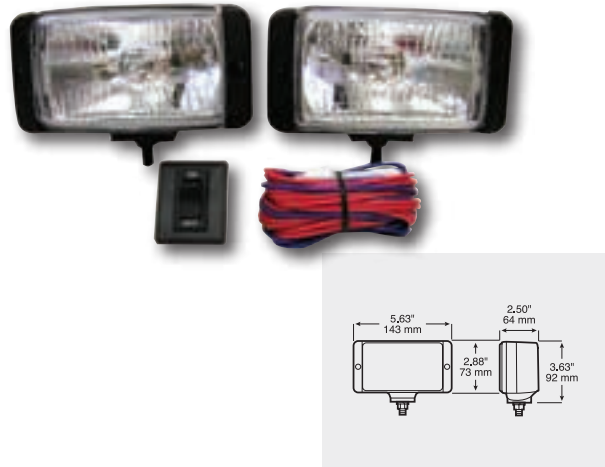

**566 Nightwatcher® LX  
Clear OE-Style Driving Light**



- Popular original equipment style clear driving light kit.
- Designed to mount in most factory and aftermarket air dams.
- Can be mounted on top or bottom of bumper.
- 55-watt halogen bulb behind replaceable, hardened-glass lens.
- Black plastic housing.
- Kit contains two lights, rocker switch, wiring, and instructions.
- Meets SAE specifications.

Order No.	Description	Pack	Std Carton
V566-1	<b>KIT</b> clear driving light kit	Viz Pack	3
VH550	replacement bulb	Viz Pack	12



**582 Nightwatcher® LX  
Slim Oval ION Fog/Docking Light**



- Attractive, low-profile clear fog light provides maximum road clearance.
- 55-watt halogen bulb behind ion-coated lens.
- Black-finished aluminum diecast housing.
- Mounts above or below bumper.
- May be used as marine docking lights.
- Screws or double-sided tape for installation on any surface.
- Kits include two lights, wiring, illuminated rocker switch, instructions.

Order No.	Description	Pack	Std Carton
V582-2	<b>KIT</b> black driving light kit	Viz Pack	3
VH550	replacement bulb	Viz Pack	12



**586 Nightwatcher® LX  
Compact Square ION Driving Light**



- Compact, modern shape.
- 55-watt halogen bulb behind ion-coated lens.
- Black metal powder-coated housing.
- May be used as marine docking lights.
- Kits include two lights, wiring, illuminated rocker switch, instructions.

Order No.	Description	Pack	Std Carton
V586-2	<b>KIT</b> black driving light kit	Viz Pack	3



## 955 LED Magnetic-Mount Tow Light Kit



- Two 8-diode auxiliary stop/turn/tail lights with magnetic bases.
- Kit includes trunk harness, 20' wire harness, connectors, and instructions.
- Strong magnetic base meets 35–40 lb. pull force test.
- 8–16 volt operating range.
- Four conductor, bonded harness uses 18 gauge copper stranded wire.
- Plugs into standard flat four-way vehicle trailer light connector.
- Packaged in 2-lamp, self-service visual pack kit.

Order No.	Description	Pack	Std Carton
V955	<b>KIT</b> complete kit	Viz Pack	2

## 555 Magnetic-Mount Tow Light Kit



- Two auxiliary warning lights with magnetic bases.
- Kit includes trunk harness, 20' four-wire harness, connectors, and instructions.
- Plugs into standard flat four-way vehicle trailer light connector.
- Packaged in attractive, self-service visual pack kit.

Order No.	Description	Pack	Std Carton
V555	<b>KIT</b> complete kit	Viz Pack	2
313-15R	red replacement lens	poly pack	10
1157	replacement bulb		<i>reference only</i>

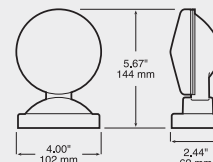
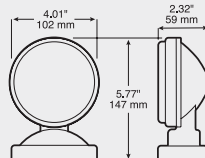

- STT
- TURN
- MARKER
- B-U/UTIL
- SPEC**
- EMERG
- ECE
- MOUNT
- ELECT
- REFLECT
- ACCY
- MERCH
- TECH



## 817S/818S LumenX® LED Auxiliary Round Strobing Lights



### • Meets SAE J595 Class 1

- Strobing light functions as auxiliary strobe or warning light.
- Ideal for emergency, construction and refuse vehicles.
- New white diodes behind white or colored lenses.
- Advanced optics fully illuminate lens.
- AMP-compatible connector integrated into housing.
- Regulated design provides voltage protection and consistent light output over a wide voltage range.
- 818-9 has flange integrated into the housing.
- 817-9 has skirted weld joint for added protection against moisture.
- 9-32 volt operating range is compatible with 12V and 24V vehicles.
- See pages 184–185 & 187 for mounting options.

Order No.	Description	Pack	Std Carton
817SA-9	amber, grommet mount	poly pack	6
818SA-9	amber, flange mount	poly pack	6
817SR-9	red, grommet mount	poly pack	6
818SR-9	red, flange mount	poly pack	6
817SW-9	white, grommet mount	poly pack	6
818SW-9	white, flange mount	poly pack	6
M817SA-9	amber, grommet mount	mfg. pack	50
M818SA-9	amber, flange mount	mfg. pack	50
426-18	grommet	poly pack	12
B426-18	grommet	mfg. pack	100
417-48	hardshell plug, 2-wire	poly pack	6
B417-48	hardshell plug, 2-wire	mfg. pack	100
817-48	molded plug, 2-wire	poly pack	12
B817-48	molded plug, 2-wire	mfg. pack	100

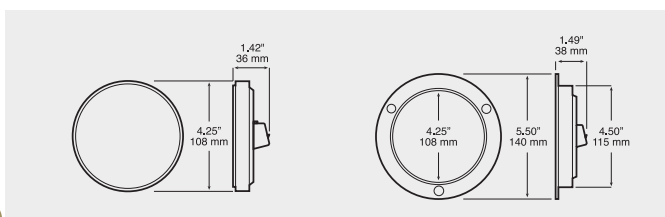

## 820S/823S LumenX® LED Auxiliary Oval Strobing Lights



### • Meets SAE J595 Class 1

- Strobing light functions as auxiliary strobe or warning light.
- Ideal for emergency, construction and refuse vehicles.
- New white diodes behind white or colored lenses.
- Advanced optics fully illuminate lens.
- AMP-compatible connector integrated into housing.
- 821SA-10 has PL3 plug integrated into housing.
- Regulated design provides voltage protection and consistent light output over a wide voltage range.
- 823-10 has flange integrated into the housing.
- 820KSA kit includes 421-18 grommet and 417-49 plug.
- 9-32 volt operating range is compatible with 12V and 24V vehicles.
- See pages 186–187 for mounting options.

Order No.	Description	Pack	Std Carton
820KSA	<b>KIT</b> amber, grommet mount kit	poly pack	6
820SA-10	amber, grommet mount	poly pack	6
823SA-10	amber, flange mount	poly pack	6
820SR-10	red, grommet mount	poly pack	6
823SR-10	red, flange mount	poly pack	6
820SW-10	white, grommet mount	poly pack	6
823SW-10	white, flange mount	poly pack	6
M820SA-10	amber, grommet mount	mfg. pack	50
M820SR-10	red, grommet mount	mfg. pack	50
M821SA-10	amber, grommet, PL3 plug	mfg. pack	50
421-18	grommet	poly pack	12
B421-18	grommet	mfg. pack	100
417-48	hardshell plug, 2-wire	poly pack	6
B417-48	hardshell plug, 2-wire	mfg. pack	100
817-48	molded plug, 2-wire	poly pack	12
B817-48	molded plug, 2-wire	mfg. pack	100

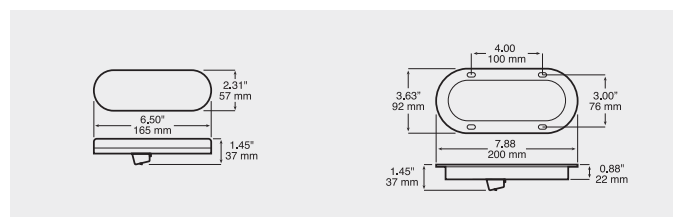

# LED AUXILIARY STROBE

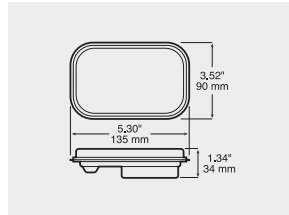

# WARNING & EMERGENCY

## 850SA LED Rectangular Auxiliary Strobing Light



- 3.5" x 5" LED light functions as auxiliary strobe or warning light.
- Two separate hot leads for selectable dual flash or quad flash strobe.
- Strobing function meets SAE J595 Class 2 specification.
- Operates from 9-32 volts.
- Ideal for emergency, construction and refuse vehicles.
- Potted, hardwired 12.25" sheathed leads. Available with AMP plug.
- Sealed lens and housing meets IP67 ingress protection level.
- Grommet fits material up to 6 mm.

Order No.	Description	Pack	Std Carton
850SA	amber	poly pack	6
850SA-AMP	amber, AMP plug	poly pack	6
B850-18	rubber grommet	mfg. pack	100

## 1197SA Single Diode LumenX® LED 2½" Round Auxiliary Strobing Light



- Functions as amber auxiliary strobe or warning light.
- Round, 2½" diameter.
- Operates from 9-16 volts.
- Integral receptacle accepts industry-standard AMP plug.
- Sealed lens and housing meets IP67 ingress protection level.
- Grommet fits material up to 6 mm.

Order No.	Description	Pack	Std Carton
1197SA	amber	mfg pack	50
143-18	grommet	poly pack	24
B143-18	grommet	mfg. pack	100
192-492	AMP plug w/ .180 bullets	poly pack	6
B192-492	AMP plug w/ .180 bullets	mfg. pack	50
B193-492	molded AMP plug, .180 bullets	mfg. pack	50

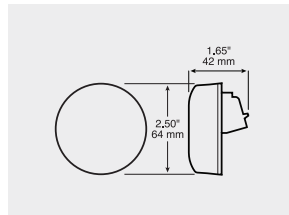

Black: power  
White: ground  
Red: sync

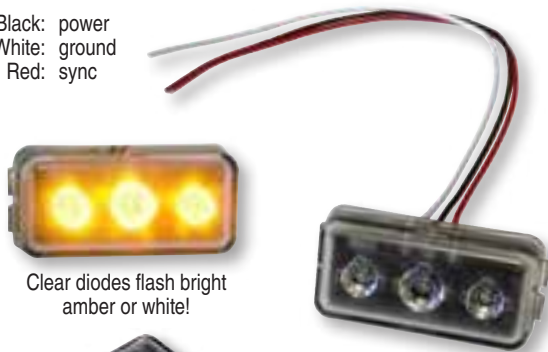

Clear diodes flash bright  
amber or white!

## 253S LED Ultra-Mini Strobing Lights w/ Sync



- 60 triple-flashes per minute meet J595 Class 1 specs.
- "Sync wire" technology allows two lamps to communicate with each other without an external strobe controller. (See next page for more information.)
- 9-16 volt operating range.
- Ultra-compact size allows installation on nearly any vertical surface.

Order No.	Description	Pack	Std Carton
253SA-1	amber, type 1	poly pack	6
253SA-2	amber, type 2	poly pack	6
253SW-1	white, type 1	poly pack	6
253SW-2	white, type 2	poly pack	6
150-095	mounting bracket	poly pack	12
B150-18	grommet	poly pack	100
B150-181	grommet	poly pack	100

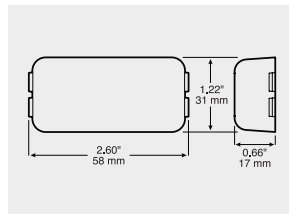

Shown in 150-095  
surface mount bracket.  
Bracket or grommet required  
for mounting, available separately.

# WARNING & EMERGENCY

**ALTERNATING, SYNCHRONOUS, OR RANDOM STROBE PATTERNS— NO EXTERNAL CONTROLLER NEEDED!**

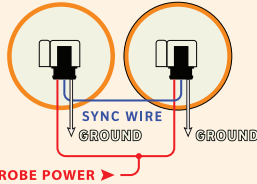

- Synchronous Strobe Pattern: Use two "-1" lamps
- Alternating Strobe Pattern: Use one "-1" and one "-2"
- Random Strobing: Leave black wire unconnected



**TRADITIONAL 36 DIODE PIRANHA®**



## 817SA Piranha® LED Auxiliary Round Strobing Lights w/ Sync



- Original 36-diode Piranha multi-diode lens look.
- AMP-compatible connector integrated into housing.
- "Sync wire" technology allows two lamps to communicate with each other without an external strobe controller.
- Operates from 9-32 volts.
- Regulated design provides voltage protection and consistent light output over a wide voltage range.
- Ideal for emergency, construction and refuse vehicles.
- Meets SAE J595 Class 2 specifications.

Order No.	Description	Pack	Std Carton
817SA-1	amber, grommet mount, pos. 1	poly pack	6
817SA-2	amber, grommet mount, pos. 2	poly pack	6
818SA-1	amber, flange mount, pos. 1	poly pack	6
818SA-2	amber, flange mount, pos. 2	poly pack	6
B426-18	grommet	mfg. pack	100
B417-49	hardshell plug, 3-wire	mfg. pack	100



# LED AUXILIARY STROBE W/ SYNC



**TRADITIONAL 22 DIODE PIRANHA®**



## 820S & 823S LED Auxiliary Oval Strobing Lights w/ Sync



- Oval, LED triple-flash strobing auxiliary or emergency warning light.
- 9-32 volt operating range, no separate external controller required.
- "Sync wire" technology allows two lamps to communicate with each other without an external strobe controller.
- Meets SAE J595 Class 2 specifications rotated in any orientation.
- 823HSA permits easy surface mounting.

Order No.	Description	Pack	Std Carton
820SA-1	amber, pos. 1	poly pack	6
820SA-2	amber, pos. 2	poly pack	6
820SR-1	red, pos. 1	poly pack	6
820SR-2	red, pos. 2	poly pack	6
823SA-1	amber w/ flange, pos. 1	poly pack	6
823SA-2	amber w/ flange, pos. 2	poly pack	6
823HSA-1	amber surface mount, pos. 1	poly pack	6
823HSA-2	amber surface mount, pos. 2	poly pack	6
421-18	grommet	poly pack	12
B421-18	grommet	mfg. pack	100
417-49	plug	poly pack	6
B417-49	hardshell plug, 3-wire	mfg. pack	100

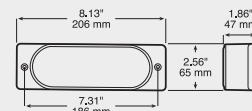
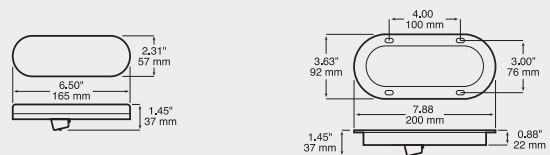



# LED PROGRAMMABLE AUX STROBE

# WARNING & EMERGENCY

**PROGRAMMABLE!**



4153SA Surface Mount



4154SA Bracket Mount

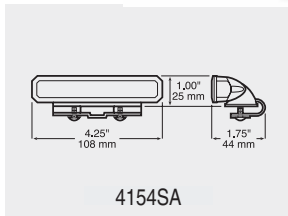

4154SA

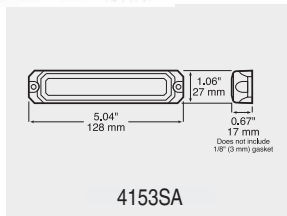

4153SA

## 4153SA/4154SA LED Programmable Compact Strobe



- **Meets SAE J595 Class 1**
- 6 super bright diodes.
- 12-24 volt operating range.
- 19 programmable flash patterns
- Solid-state design.
- 4153SA features screw-on surface mounting and includes foam base gasket.
- 4154SA comes with adjustable, clamp-on/adhesive mounting bracket.
- All mounting hardware included.

Order No.	Description	Pack	Std Carton
P4153SA	amber, surface mount	poly pack	1
P4154SA	amber, bracket mount	poly pack	1
4153SA	amber, surface mount	box	1
4154SA	amber, bracket mount	box	1

**PROGRAMMABLE!**

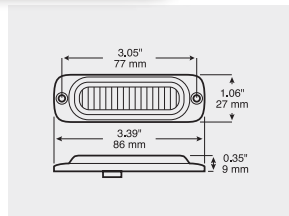

## 4155SA LED Programmable Low-Profile Surface-Mount Strobe



- Low-profile LED amber warning strobe.
- Screw mounts on 3-inch centers.
- 12 programmable flash patterns.
- Meets SAE J595 Class 1.
- 3 super bright diodes.
- Compatible with 12VDC and 24VDC systems.
- Aluminum base for heat dissipation.
- Multiple units can synchronize for simultaneous or alternating flash.

Order No.	Description	Pack	Std Carton
P4155SA	surface mount	poly pack	1
4155SA	surface mount	box	1
4155SA-BT3	surface mount w/ .180 bullets	box	1

**PROGRAMMABLE!**

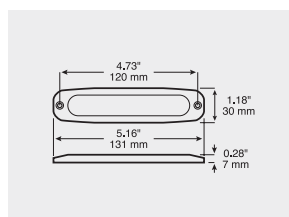

## 4156SA LED Programmable Surface-Mount Strobe Pad



- Low-profile LED amber warning strobe with pad mount.
- Mounts using screws and high-strength self-adhesive backing (both included).
- 23 programmable flash patterns.
- Meets SAE J595 Class 1 & ECE Reg 10.
- 6 super bright diodes.
- Compatible with 12VDC and 24VDC systems.
- Aluminum base for heat dissipation.
- Multiple units can synchronize for simultaneous or alternating flash.

Order No.	Description	Pack	Std Carton
P4156SA	surface mount	poly pack	1
4156SA	surface mount	box	1
4156SA-BT3	surface mount w/ .180 bullets	box	1

## MULTI-FUNCTION STROBES FUNCTION AS TURN SIGNALS!

Each lamp has electronic strobe and turn signal functions built-in, with no external strobe controller. Activating turn signal automatically overrides strobe function. Two power wires allow strobes to be activated with cab switch and automatically when shifted into reverse.

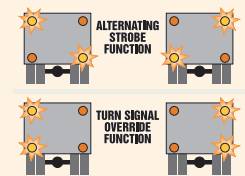
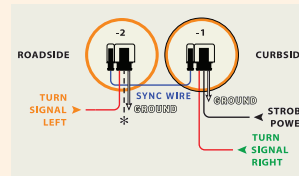
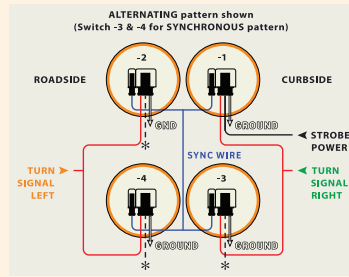

\* Center terminal provides power to -1 lamp only; the sync wire provides power to other lamps in the system. Two-wire AMP plugs are recommended for -2, -3, and -4 lamps. If three-wire AMP plug are used with these lamps, all unused wires must be properly sealed against moisture/corrosion.



### 867SA LumenX® LED Strobe & Rear Turn Signal w/ Sync



- Two- or four-lamp system functions as both alternating strobes and DOT-compliant rear turn signals.
- Activating turn signal automatically overrides strobe function.
- Requires no external strobe controller. (Requires standard vehicle flasher for turn function.)
- Meets SAE J595 Class 2 specifications. Requires 426-18 grommet, 417-49 3-wire plug, and 880-49 or 866-486 single wire sync plug for installation.

Order No.	Description	Pack	Std Carton
867SA-1	amber, curbside high	poly pack	6
867SA-2	amber, roadside high	poly pack	6
867SA-3	amber, curbside low	poly pack	6
867SA-4	amber, roadside low	poly pack	6
M867SA-1	amber, curbside high	mfg. pack	50
M867SA-2	amber, roadside high	mfg. pack	50
B426-18	grommet	mfg. pack	100
B417-49	hardshell plug, 3-wire	mfg. pack	100
880-49	plug, sync wire, stripped lead	poly pack	6
B880-49	plug, sync wire, stripped lead	mfg. pack	100
866-486	plug, sync wire, Packard connector	poly pack	6
B866-486	plug, sync wire, Packard connector	mfg. pack	100

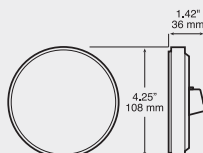

### 860SA LumenX® LED Strobe & Rear Turn Signal w/ Sync



- Two- or four-lamp system functions as both alternating strobes and DOT-compliant rear turn signals.
- Activating turn signal automatically overrides strobe function.
- Requires no external strobe controller. (Requires standard vehicle flasher for turn function.)
- Meets SAE J595 Class 2 specifications rotated in any orientation.
- Requires 421-18 grommet, 417-49 3-wire plug, and 880-49 single wire sync plug for installation.

Order No.	Description	Pack	Std Carton
860SA-1	amber, curbside high	poly pack	6
860SA-2	amber, roadside high	poly pack	6
860SA-3	amber, curbside low	poly pack	6
860SA-4	amber, roadside low	poly pack	6
B421-18	grommet	mfg. pack	100
B417-49	hardshell plug, 3-wire	mfg. pack	100
880-49	plug, sync wire, stripped lead	poly pack	6
B880-49	plug, sync wire, stripped lead	mfg. pack	100
866-486	plug, sync wire, Packard connector	poly pack	6
B866-486	plug, sync wire, Packard connector	mfg. pack	100

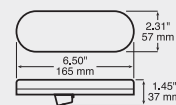

## MULTI-FUNCTION STROBES FUNCTION AS TURN SIGNALS!

Each lamp has electronic strobe and turn signal functions built-in, with no external strobe controller. Activating turn signal automatically overrides strobe function. Two power wires allow strobes to be activated with cab switch and automatically when shifted into reverse.

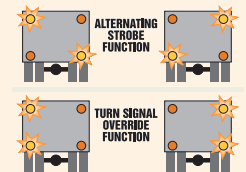
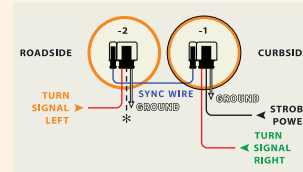
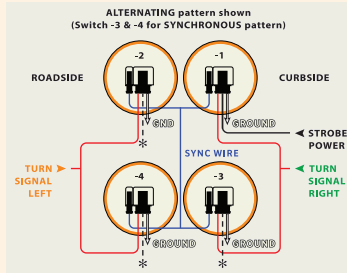

\* Center terminal provides power to -1 lamp only; the sync wire provides power to other lamps in the system. Two-wire AMP plugs are recommended for -2, -3, and -4 lamps. If three-wire AMP plug are used with these lamps, all unused wires must be properly sealed against moisture/corrosion.



**TRADITIONAL  
36 DIODE  
PIRANHA®**



### 866SA Piranha® LED Strobe & Rear Turn Signal w/ Sync



- Two- or four-lamp system functions as both alternating strobes and DOT-compliant rear turn signals.
- Activating turn signal automatically overrides strobe function.
- Requires no external strobe controller. (Requires standard vehicle flasher for turn function.)
- Meets SAE J595 Class 2 specifications rotated in any orientation.
- Requires 426-18 grommet, 417-49 3-wire plug, and 880-49 single wire sync plug for installation.

Order No.	Description	Pack	Std Carton
866SA-1	amber, grommet mnt. curbside high	poly pack	6
866SA-2	amber, grommet mnt. roadside high	poly pack	6
866SA-3	amber, grommet mnt. curbside low	poly pack	6
866SA-4	amber, grommet mnt. roadside low	poly pack	6
M866SA-1	amber, curbside high	mfg. pack	50
M866SA-2	amber, roadside high	mfg. pack	50
B426-18	grommet	mfg. pack	100
B417-49	hardshell plug, 3-wire	mfg. pack	100
880-49	plug, sync wire, stripped lead	poly pack	6
B880-49	plug, sync wire, stripped lead	mfg. pack	100
866-486	plug, sync wire, Packard connector	poly pack	6
B866-486	plug, sync wire, Packard connector	mfg. pack	100

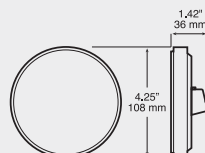

**TRADITIONAL  
22 DIODE  
PIRANHA®**



### 861SA Piranha® LED Strobe & Rear Turn Signal w/ Sync



- Two- or four-lamp system functions as both alternating strobes and DOT-compliant rear turn signals.
- Activating turn signal automatically overrides strobe function.
- Requires no external strobe controller. (Requires standard vehicle flasher for turn function.)
- Meets SAE J595 Class 2 specifications rotated in any orientation.
- Requires 421-18 grommet, 417-49 3-wire plug, and 880-49 single wire sync plug for installation.

Order No.	Description	Pack	Std Carton
861SA-1	amber, curbside high	poly pack	6
861SA-2	amber, roadside high	poly pack	6
861SA-3	amber, curbside low	poly pack	6
861SA-4	amber, roadside low	poly pack	6
B421-18	grommet	mfg. pack	100
B417-49	hardshell plug, 3-wire	mfg. pack	100
880-49	plug, sync wire, stripped lead	poly pack	6
B880-49	plug, sync wire, stripped lead	mfg. pack	100
866-486	plug, sync wire, Packard connector	poly pack	6
B866-486	plug, sync wire, Packard connector	mfg. pack	100

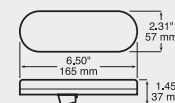

STT  
TURN  
MARKER  
B-U/UTIL  
SPEC  
EMERG  
ECE  
MOUNT  
ELECT  
REFLECT  
ACCY  
MERCH  
TECH



Rear view shows twin magnets and push-button switch

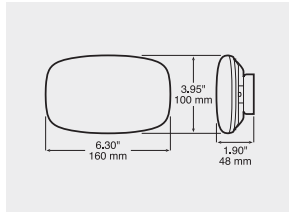

316 LED

Battery-Operated Hazard Light w/ Magnetic Mount



- 6" x 4" battery-powered, portable LED flashing light.
- Available in amber or red.
- Magnetic mount attaches securely to back of vehicle or trailer.
- 18 bright, highly visible diodes.
- 3-way switch for flashing or steady-on operation.
- 180 flashes per minute in flash mode.
- Requires four AA batteries (not included).
- Can flash for 36 hours or more on one set of alkaline batteries.
- Can be optionally configured as self-standing easel.
- Sealed lens and base.

Order No.	Description	Pack	Std Carton
V316MA	amber	Viz Pack	4
V316MR	red	Viz Pack	4

740 LED

Battery-Operated Safety Beacon w/ Magnetic Mount



- General purpose, battery-powered, portable light.
- 300-400 hour run time on 2 D batteries (not included).
- Carry strap included.
- Heavy-duty magnetic base.
- Optional mounting bracket available.
- 65 flashes per minute.
- Photocell mode switch located inside battery compartment.

Order No.	Description	Pack	Std Carton
740A	amber	box	1
740R	red	box	1
740-09	bracket	box	1

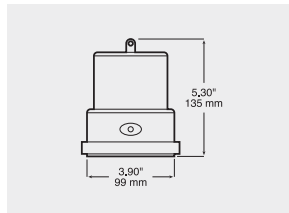

740-09 Bracket

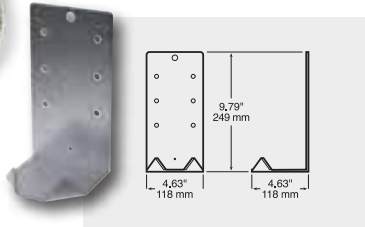

772 LED

Alternating Beacon w/ Magnetic Mount



- 16 bright amber diodes.
- Alternating upper and lower flashing compartments.
- 90 flashes per minute.
- Low amp draw.
- 9-16 volt operating range.
- Integral 12' coil cord and lighter socket plug.
- Mounts with three powerful magnets in base.

Order No.	Description	Pack	Std Carton
V772A	amber	Viz Pack	4

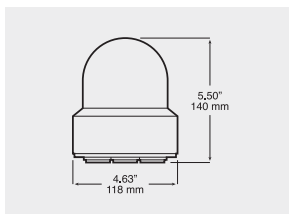
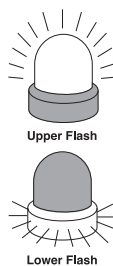

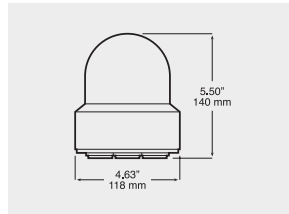
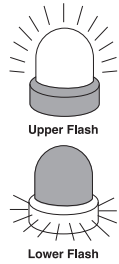

773

Alternating Beacon w/Magnetic Mount



- Twin incandescent bulbs flash alternately.
- 12 volt.
- 90 flashes per minute.
- Solid-state design for reliable, silent operation.
- Mounts with three powerful magnets in base.
- 12' coil cord with lighter socket plug.
- See 772 LED version on previous page.

Order No.	Description	Pack	Std Carton
V773A	amber	Viz Pack	2
771-15A	amber replacement lens	box	1
R10W	replacement bulb		reference only

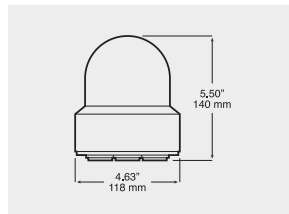

771

Economy Revolving Beacon



- 12 volt.
- Incandescent bulb.
- 60 flashes per minute.
- Low-noise drive motor.
- Mounts with three powerful magnets in base.
- 12' coil cord with lighter socket plug.

Order No.	Description	Pack	Std Carton
V771A	amber	Viz Pack	2
V771B	blue	Viz Pack	4
771-15A	amber replacement lens	box	1
771-15B	blue replacement lens	box	1
771-15R	red replacement lens	box	1
R10W	replacement bulb		reference only

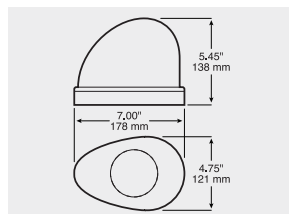

774

Teardrop Revolving Beacon



- 12 volt incandescent bulb.
- 90+ flashes per minute.
- Polished rotating reflector for maximum output.
- Low-noise drive motor.
- Magnetic mount.
- 12' coil cord with lighter socket plug.

Order No.	Description	Pack	Std Carton
V774A	amber	Viz Pack	4
V774R	red	Viz Pack	4
774-15A	amber replacement lens	box	1
774-15B	blue replacement lens	box	1
774-15R	red replacement lens	box	1
1141	replacement bulb		reference only

STT  
TURN  
MARKER  
B-U/UTIL  
SPEC  
EMERG  
ECE  
MOUNT  
ELECT  
REFLECT  
ACCY  
MERCH  
TECH



**TRIPLE  
LENS  
DESIGN**

**763  
Revolving Beacon**



- Low cost, magnetic-mount revolving light.
- For use with 12 volt vehicles.
- 6,600 candle power from incandescent bulb with reflector.
- Rotating reflector provides 135 flashes per minute.
- Acrylic lens.
- Rubber-covered aluminum base with 60 lb. magnet.
- Equipped with 15' straight cord and lighter socket plug with built-in on/off switch and LED indicator.
- Red and blue lenses also available by special order only.

Order No.	Description	Pack	Std Carton
763A	amber	box	1
756-15A	amber replacement lens	box	1
BB-22	replacement motor and gear	box	1
1195	replacement bulb		<i>reference only</i>

**756  
Revolving Light**



- Available in 12 volt or 24 volt versions.
- Center-mounted 50 candle power incandescent bulb.
- 110 flashes per minute.
- Three rotating 2 1/4" polycarbonate bulls-eye lenses.
- Stainless steel base.
- 756MA includes magnetic base and lighter socket plug.

Order No.	Description	Pack	Std Carton
756A	amber, 12V	box	1
756MA	amber, 12V magnetic mount	box	1
756A24	amber, 24V	box	1
756R24	red, 24V	box	1
756-15A	amber replacement lens	box	1
756-15B	blue replacement lens	box	1
756-15R	red replacement lens	box	1
756-21	retainer	poly pack	1
756-23	gasket	poly pack	1
BB-22	replacement motor and gear	box	1
1195	replacement bulb		<i>reference only</i>

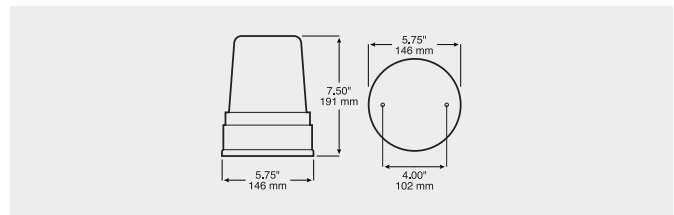
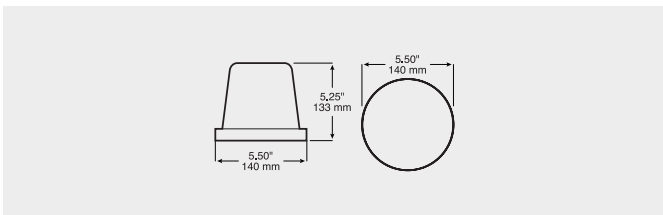

# LED STROBING BEACONS

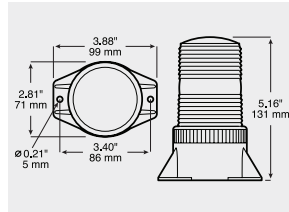

## 744 LED 360° Micro Strobing Beacon

6 diodes LED Strobe MW Multi-Volt 12V & 24V REG Voltage Regulated

- High-performance LED strobe with compact dimensions.
- Meets SAE J845, Class 3 specifications.
- 60 quad flashes per minute.
- Six super bright diodes.
- Rugged polycarbonate lens and base.
- Low 0.5 amp maximum current draw.
- 12-80 volt operating range.
- Surface mounts with two screws or bolts.

Order No.	Description	Pack	Std Carton
744A	amber	box	1

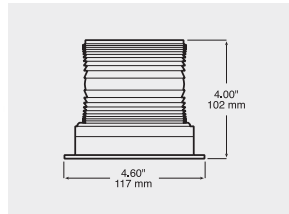

## 745 LED 360° Strobing Beacon

4 diodes USA MADE LED Strobe MW Multi-Volt 12V & 24V

- Designed for vehicle applications where a small very bright warning light is required.
- Meets SAE J845, Class 2A specifications.
- 72 quad flashes per minute.
- Four (4) super bright diodes on sq. extrusion (1 per side).
- Polycarbonate lens and base are sonic welded.
- Low 1.2 amp maximum current draw.
- Compatible with 12V and 24V vehicles.
- Standard 3-hole mounting.

Order No.	Description	Pack	Std Carton
745A	amber	box	1

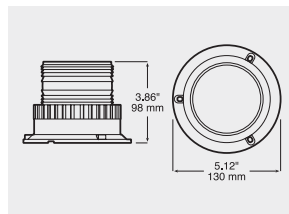

## 762 LED 360° Strobing Beacon

3 diodes LED Strobe MW Multi-Volt 12V & 24V

- 65 "double-quad" flashes per minute.
- Meets SAE J845 Class 3A specifications.
- Ideal for material handling equipment.
- Polycarbonate lens and base.
- 11-110 volt operating range.
- 11" lead wires.
- Reverse voltage protected.
- Low amp draw: 0.15@12v, .13 @48v.
- Standard 3-hole mounting on 4.57" bolt circle.

Order No.	Description	Pack	Std Carton
762A	amber	box	1

STT  
TURN  
MARKER  
B-U/UTIL  
SPEC  
EMERG  
ECE  
MOUNT  
ELECT  
REFLECT  
ACCY  
MERCH  
TECH



## 764 LED Micro-Strobe Light



- 16 super bright diodes.
- 9-36 volt operating range.
- 65 triple flashes per minute.
- Meets SAE J845, Class 2A specifications.
- Solid-state design.
- Screw-on fresnel lens design with weather-resistant O-ring seal.
- Permanent mount version mounts on 3-hole, 4.57" bolt circle using #8 screws, or on pipe with 1/2-14 American National Pipe threads.
- Magnetic mount version includes 24" coil cord and lighter socket plug.
- Replaces 766A & 766MA

Order No.	Description	Pack	Std Carton
V764MA	amber, magnetic	Viz Pack	2
764A	amber	box	1
766-25A	amber replacement lens	box	1

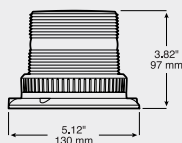

## 791 LED Low Profile 360° Strobing Beacon



- Four super-high output 2.5W LEDs.
- 360° display and 4 User-selectable patterns.
- Multivolt configuration is compatible with 12 and 24 volt systems.
- Low 0.8 amp maximum current draw.
- Meets SAE J845 Class 2A specifications.
- Polycarbonate lens and flange base.
- Magnetic-mount version has 15' cord and plug with integral switch.

Order No.	Description	Pack	Std Carton
791A	flange mount	box	1
791MA	magnetic mount	box	1
791-25A	amber replacement lens	box	1

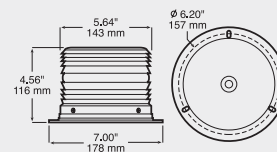





**CLASS 1  
SPEC**



## 792 LED Double Flash School Bus Beacon



- White strobe for school bus applications
- Meets SAE J845 Class 1 specifications.
- 12-24 volt operating range.
- 70 dual flashes per minute.
- Exceeds the brightness of a typical 14-joule xenon strobe.
- Polycarbonate lens and base.
- Includes durable foam mounting gasket.

Order No.	Description	Pack	Std Carton
792C	white	box	1
L3-77	replacement strobe tube	box	1

## 797 LED 360° Strobing Beacon



- Single amber quad flash function.
- Meets SAE J845 Class 2A specifications.
- Ideal for material handling equipment.
- 65 quad flashes per minute.
- Polycarbonate lens and base.
- 9-36 volt operating range.
- 18" wire lengths with strip wires.
- Reverse voltage protected.
- Low amp draw: 0.56@12v, 0.25 @28v.
- Standard 3-hole mounting.
- Replaces 767A-2 & 767A-3

Order No.	Description	Pack	Std Carton
797A	amber	box	1

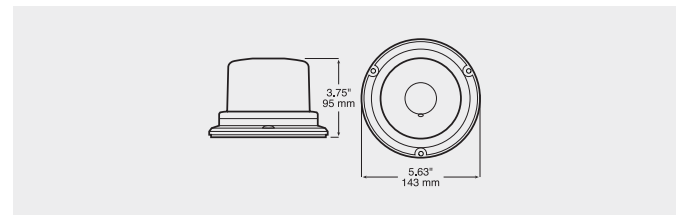
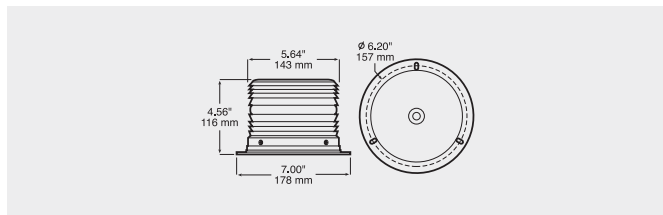

STT
TURN
MARKER
B-U/UTIL
SPEC
EMERG
ECE
MOUNT
ELECT
REFLECT
ACCY
MERCH
TECH

**PROGRAMMABLE!**

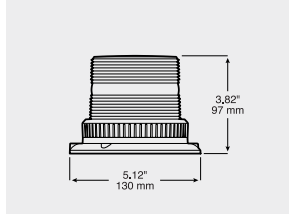

**764-2 LED**

**Programmable Micro-Strobe Light**



- 16 super bright diodes.
- 9–36 volt operating range.
- 3-wire, programmable design.
- Six flash patterns: steady burn, single flash, double, quad, quint, ultra.
- Meets SAE J845, Class 2A specifications.
- Solid-state design.
- Screw-on fresnel lens design with weather-resistant O-ring seal.
- Mounts on 3-hole, 4.57 " bolt circle using #8 screws, or on pipe with 1/2-14 American National Pipe threads.

Order No.	Description	Pack	Std Carton
764A-2	amber	box	1
766-25A	amber replacement lens	box	1

**PROGRAMMABLE!**

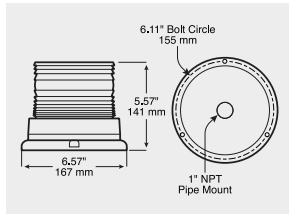

**798 LED**

**Programmable 360° Strobing Beacon**



- 5.6" tall.
- Meets SAE J845 Class 1A specifications in modes 2,4 & 7.
- 360° display and 20 User-selectable patterns.
- 11–28 volt operating range.
- Multivolt configuration is compatible with 12 and 24 volt systems.
- 12" cable.
- Black aluminum base.
- Permanent base mounts with pipe or 3 screws for easy, secure installation.

Order No.	Description	Pack	Std Carton
798A	amber	box	1

**PROGRAMMABLE!**

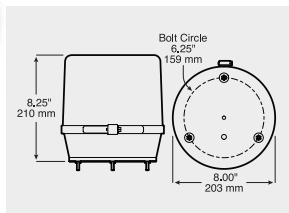

**799 LED**

**Programmable 360° Strobing Beacon**



- 8.25" tall.
- Ruggedized design for construction/heavy-duty applications
- Five user-selectable flash patterns:
  - ① Quad flash (72 qfpm)
  - ② Fast single flash (80 fpm)
  - ③ Slow single flash (50% on time)
  - ④ Random Flash
  - ⑤ Hex flash (60 hex bursts/min)
- Meets SAE J845 Class 1A specifications in modes 3 & 5.
- Multivolt configuration is compatible with 12 and 24 volt systems.
- Comes with mounting bolts attached to base.

Order No.	Description	Pack	Std Carton
799A	amber, pipe mount	box	1

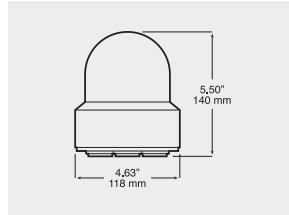

## 768

### Economy Strobe Beacon



- 12 to 24 volt operating range.
- Double flash.
- 120 flashes per minute.
- Mounts with three powerful magnets in base.
- 12' coil cord with lighter socket plug.

Order No.	Description	Pack	Std Carton
V768A	amber	Viz Pack	4
771-15A	amber replacement lens	box	1

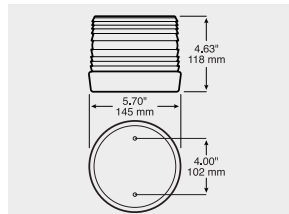

## 769

### 2 Joule Single Flash Strobe Beacon



- 12 volt
- 60 single flashes per minute
- 2 joule/150 candela-second brightness
- Shock-resistant rubber base, encapsulated circuitry
- Magnetic-mount model is equipped with 15' coil cord and lighter socket plug with built-in on/off switch and LED indicator.

Order No.	Description	Pack	Std Carton
769A	amber	box	1
769B	blue	box	1
769C	clear	box	1
769R	red	box	1
769MA	amber, magnetic	box	1
769-25A	amber replacement lens	box	1
769-25B	blue replacement lens	box	1
769-25C	clear replacement lens	box	1
769-25R	red replacement lens	box	1
L2-77	replacement strobe tube	box	1



769-1HA equipped with 6" tall lens

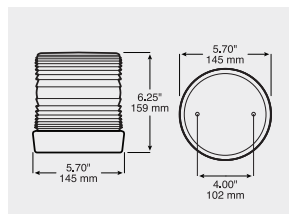
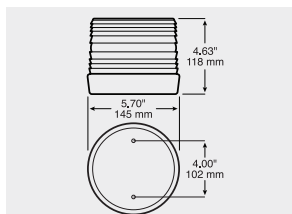

## 769-1

### 4 Joule Double Flash Strobe Beacon



- 12-48 volt operating range.
- 60 double flashes per minute.
- 4 joule/300 candela-second brightness.
- Shock-resistant rubber base, encapsulated circuitry.
- See 769 strobe for replacement 4 1/2" lenses and strobe tube.

Order No.	Description	Pack	Std Carton
769-1A	amber	box	1
769-1B	blue	box	1
769-1C	clear	box	1
769-1R	red	box	1
769-1HA	amber, 6" tall	box	1
769-25HA	amber repl. 6" lens	box	1

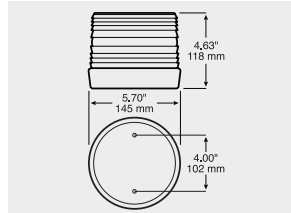

769-2

5 Joule Quad Flash Strobe Beacon

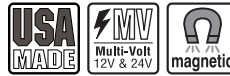

- 12-48 volt operating range.
- 65 quad flashes per minute.
- 5 joule/400 candela-second brightness.
- Shock-resistant rubber base, encapsulated circuitry.
- Magnetic-mount and equipped with 15' cord and lighter socket plug with built-in on/off switch and LED indicator.
- See 769 strobe for replacement lenses.

Order No.	Description	Pack	Std Carton
769-2MA	amber, magnetic	box	1
L2X-77	replacement strobe tube	box	1

Heavy Duty Construction

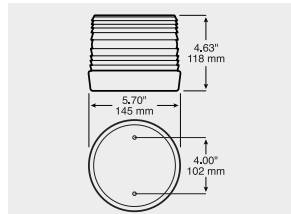

787

6 Joule Extreme Duty Strobe Beacon



- Heavy duty, U-shaped strobe tube withstands high vibration.
- 12-24 volt operating range.
- 65 double flashes per minute.
- 6 joule/150 candela-second brightness.
- Polycarbonate fresnel lens.
- Shock-resistant rubber base and encapsulated circuitry resist dust, high humidity, and salt spray.
- See 769 strobe for replacement lenses.
- Blue, clear, green and red also available by special order only.

Order No.	Description	Pack	Std Carton
787A	amber	box	1
STU15AM-77	replacement strobe tube	box	1

789

10 Joule Quad Flash Strobe Beacon

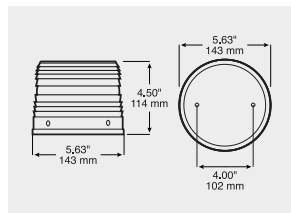
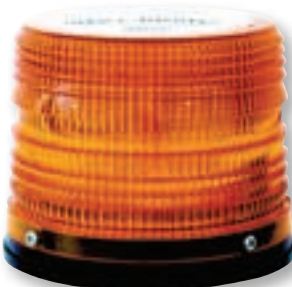
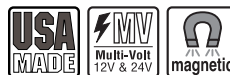

- 12-24 volt operating range.
- 75 quad flashes per minute.
- 10 joule/825 candela-second brightness.
- Meets SAE Class 2A specifications.
- Corrosion-free polycarbonate base and fresnel lens.
- Magnetic-mount model is equipped with 15' cord and lighter socket plug with built-in on/off switch and LED indicator.
- See 769 strobe for replacement lenses.

Order No.	Description	Pack	Std Carton
789A	amber	box	1
789R	red	box	1
789MA	amber, magnetic	box	1
L3-77	replacement strobe tube	box	1



## Heavy Duty Construction

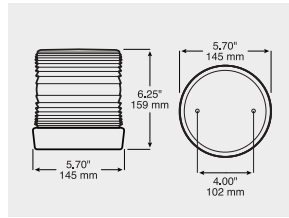

788

## 15 Joule Extreme-Duty Strobe Beacon



- Heavy duty, helical, xenon strobe tube withstands high vibration.
- Anti-shock suspended fixture to further isolate strobe tube.
- 12-24 volt operating range.
- 60 double flashes per minute.
- 15 joule/900 candela-second brightness.
- Low 1.6 amp current draw.
- Meets SAE Class 1A specifications.
- 6" tall polycarbonate fresnel lens.
- Shock-resistant rubber base and encapsulated circuitry resist dust, high humidity, and salt spray.
- Blue, clear, green and red also available by special order only.

Order No.	Description	Pack	Std Carton
788A	amber	box	1
769-25HA	amber replacement lens	box	1
585-77	replacement strobe tube	box	1

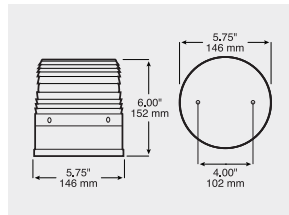

790

## 17 Joule Quad Flash Strobe Beacon



- 12-24 volt operating range.
- 70 quad flashes per minute.
- 17 joule/650 candela-second brightness.
- Meets SAE J845 Class 2A specifications.
- Powder-coated aluminum base and fresnel lens.
- See 769 strobe for replacement lenses.

Order No.	Description	Pack	Std Carton
790A	amber	box	1
790B	blue	box	1
790C	clear	box	1
790R	red	box	1
L7-77	replacement strobe tube	box	1

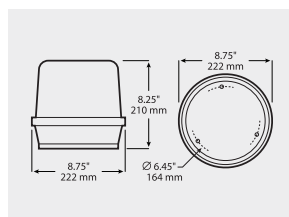

793

## 17 Joule Quad Flash Strobe Beacon



- 12-24 volt operating range.
- 70 quad flashes per minute.
- 17 joule/1200 candela-second brightness.
- Meets SAE J845 Class 2A specifications.
- Inner polycarbonate fresnel lens with outer acrylic lens cover.
- Corrosion-free polycarbonate base with stainless steel clamp ring.
- Blue, clear and red lenses also available by special order only.
- See 799A LED version on page 152.

Order No.	Description	Pack	Std Carton
793A	amber, 12-24V	box	1
755-15A	amber replacement lens	box	1
769-25C	clear inner repl. lens	box	1
L7-77	replacement strobe tube	box	1

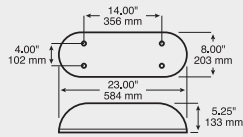
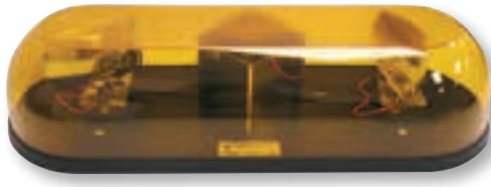

761

23" Revolving Halogen Mini Light Bar



- Dual 12 volt, 55-watt halogen bulbs with dual rotating reflectors.
- 270 FPM flash rate.
- Modular construction with field-replaceable lens, bulbs and motor.
- Magnetic mount model features four 75 lb. vertical pull magnets, 15' straight cord and lighter socket plug with integral on/off switch.

Order No.	Description	Pack	Std Carton
761A	amber, permanent	box	1
761MA	amber, magnetic	box	1
760-25A	amber replacement lens	box	1
VH550	halogen replacement bulb	Viz Pack	12

**PROGRAMMABLE!**

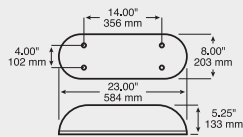

760

Programmable 23" Xenon Strobe Mini Light Bar



- Alternating quad-flash strobes produce 75 quad flashes per min.
- 12-24 volt operating range.
- Meets SAE J845 Class 2A specifications.
- Amber outer lens and clear fresnel lenses.
- Polycarbonate outer lens and powder-coated metal base.
- Magnetic mount model features four 45 lb. magnets, 15' straight cord and lighter socket plug with integral on/off switch.
- Permanent mount unit has 36" lead wires.

Order No.	Description	Pack	Std Carton
760A	amber, permanent	box	1
760MA	amber, magnetic	box	1
760-25A	amber repl. outer lens	box	1
760-25C	clear repl. outer lens	box	1
769-25A	amber repl. inner lens	box	1
769-25C	clear repl. inner lens	box	1
L3-77	replacement strobe tube	box	1

**PROGRAMMABLE!**



Quick-disconnect cord standard



751A LED

Programmable Low Profile Strobing Mini Light Bar

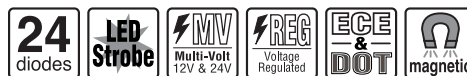

- 360° display with 23 user-selectable patterns.
- Output meets SAE J845 Class 1A & ECE R10-04 in flash modes 10,12,13, & 15.
- Multivolt configuration is compatible with 12 and 24 volt systems.
- Mounts permanently, or use optional magnetic mount kit that includes dual-switch standard accessory plug and twin suction/magnet mounting cups.
- Integral reverse polarity protection.
- Current draw is 3.8 amps @ 12V, 1.9 amps @ 24V.
- 6 amp fuse recommended.

Order No.	Description	Pack	Std Carton
751A	amber, permanent mount	box	1
751-24K	magnetic mount kit	box	1

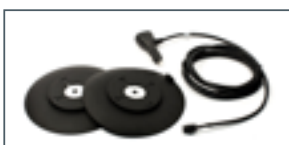

Magnetic mount kit available

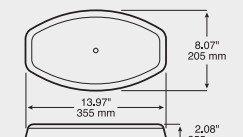

**PROGRAMMABLE!**



752MA magnetic version includes flash pattern selector switch on plug

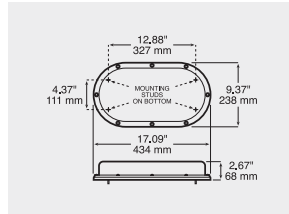

## 752 LED

### Low Profile Strobing Mini-Bar



- SAE J845 Class 2A light output
- Compatible with both 12 and 24 volt systems
- 2.75" low profile dome, 17.25" wide
- Low 1.4 amp maximum current draw
- Select from three different flash patterns.
- 752MA Magnetic mount version includes 15' straight cord and plug with on/off switch and flash mode selector button.
- 752 permanent mount version includes extra lead wire for flash pattern selection. Momentarily connecting this to the positive (+) lead advances the flash pattern. This can be done prior to installation or wired to a momentary switch (not included).

Order No.	Description	Pack	Std Carton
752A	permanent mount	box	1
752MA	w/ cord, plug & switch	box	1

**PROGRAMMABLE!**



Replacement cable available separately.

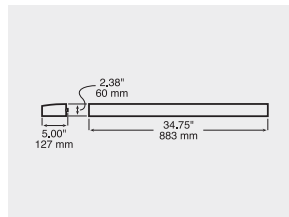

## 778 LED

### 35" Sequencing Directional Light Bar



- Eight lamp heads.
- 12-24 volt operating range.
- Low 1.4 amp draw.
- 16 different flash modes.
- Low profile, powder-coated aluminum housing.
- Includes 25' cable, touch pad controller and two L-shaped brackets.

Order No.	Description	Pack	Std Carton
778A	amber	box	1
778-48	replacement cable	poly pack	1



Includes three-switch control box.

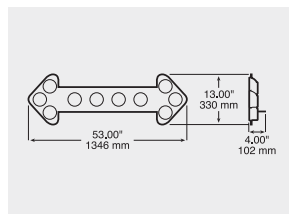

## 779-1 LED

### 55" Arrow Stick



- Ten bright, multi-volt LED lamps feature extra long life and low amp draw.
- Four traffic control flash modes—left arrow, right arrow, center lamps only, and all lamps flashing.
- Aluminum housing with black powder coat finish and horizontal mounting flange.
- Includes 25' cable and power control box.



Order No.	Description	Pack	Std Carton
779-1A	amber	box	1
M817A-9	replacement light	mfg. pack	50
779-40	replacement control box	mfg. pack	1

**ECE COMPLIANT LIGHTING: SERVING MARKETS ABROAD**

The United Nations Economic Commission for Europe (UNECE), founded in 1947, works to promote pan-European economic integration. The European Union (EU) works closely with the UNECE in developing its uniform vehicle equipment code for member states, so EU vehicle lighting requirements mirror UNECE standards to a great degree. Peterson's ECE-compliant lighting products are certified to meet the applicable legal requirements for road vehicles in EU member countries and in other nations around the world that subscribe to ECE vehicle equipment standards.



Product listings featuring this icon meet both DOT and ECE vehicle equipment standards, and are legal for use both in North American and ECE markets. These are listed in the various other parts of this catalog.



Peterson manufactures the products listed in this ECE-compliant section for our customers who serve markets outside North America. Vehicle equipment regulations in the United States, Canada and Mexico differ from those in EU/ECE nations; use of these lights may violate national or local laws. US Federal regulations expressly forbid the sale of these lights domestically as replacements or substitutes for required DOT-compliant vehicle lighting equipment.



**701C LED ECE-Compliant  
7" (178 mm) PAR 56 Headlight**

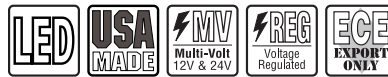

- LED PAR56 7-inch replacement is brighter and lasts many times longer than traditional sealed-beam headlights.
- Compliant with ECE Regs 112 & 7 for left-hand traffic.
- 1350 / 1700 lumen output (low/high beam).
- Built-in ECE front position lamp function with dedicated LEDs.
- H4 connection and position lamp blade terminal integrated into housing.
- Multivolt design is compatible with both 12V and 24V systems.
- Low power consumption — 2.1A @ 12V, 1.0A @ 24V.
- 5400k~6300k color temperature closely matches natural daylight.
- UV- and impact-resistant, hard-coated polycarbonate lens.
- Includes two masking decals (required when driving in countries with right-hand traffic), along with application template and instructions.
- Requires 701-491 anti-flicker harness for use on CANBUS-equipped vehicles, including '07 and newer Jeep Wrangler.
- Does not function as a daytime running light (DRL).



701-491  
anti-flicker harness

Order No.	Description	Pack	Std Carton
701C-ECE-LHT	ECE for Left Hand Traffic	box	1
701-491	anti-flicker harness	poly pack	1
701-83	replacement masking decal kit	mfg. pack	1



Includes two masking decals and application template.

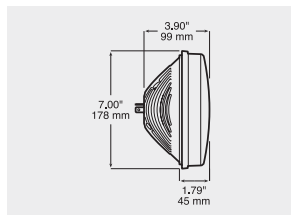



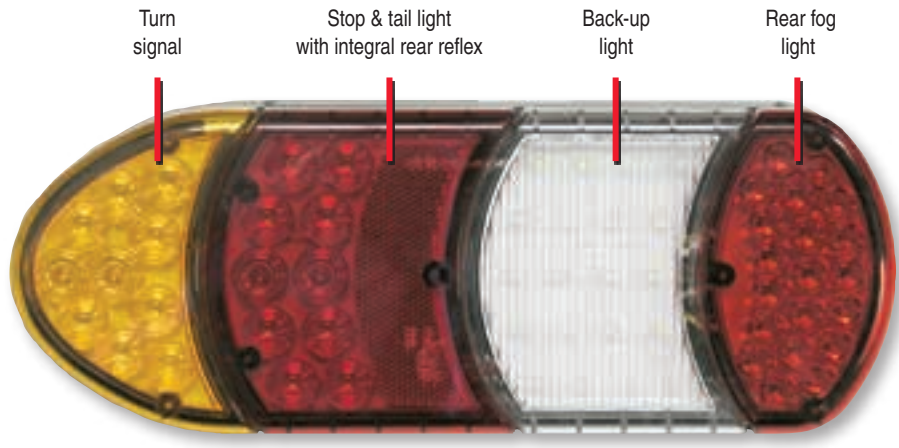

End-positioned side marker light standard



Two receptacles on either side accept optional license light  
Two standard receptacle covers keep debris out



All component modules available separately for replacement of individual components.



## 1288 LED ECE-Compliant Stud-Mount Rear Cluster Light



- Combination side marker, Combination tail, stop, rear fog, turn signal and back-up light.
- Integral rear reflex.
- Certified to applicable ECE regulations.
- Surface mounts with four studs.
- Universal design mounts on left or right side of vehicle.
- Multi-volt design is compatible with both 12 and 24 volt systems.
- Hardwired design features 12" (300 mm) sheathed cable with a single 6-pole AMP plug for all wiring connections.
- Sealed components meet IP67 ingress protection level.
- Optional snap-in rear license plate light (not included with 1288 light).
- Individual replacement light modules sold separately.
- Replacement modules come with adhesive-filled heat-sealable connectors for corrosion resistant butt-splices to existing wiring.

Order No.	Description	Pack	Std Carton
1288	cluster light assy, stud mount	mfg. pack	10
1288C	optional white license plate module	mfg. pack	10
1288A	replacement side marker	mfg. pack	10
1288B	replacement back-up light	mfg. pack	10
1288F	replacement rear fog light	mfg. pack	10
1288R	replacement tail/stop light	mfg. pack	10
1288TA	replacement turn signal	mfg. pack	10

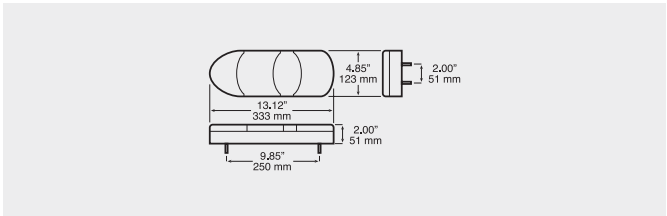

STT  
TURN  
MARKER  
B-U/UTIL  
SPEC  
EMERG  
ECE  
MOUNT  
ELECT  
REFLECT  
ACCY  
MERCH  
TECH

## 2290A-R LED ECE Compliant Combination Stop, Rear Turn & Tail Light



- Updated lens design with new Fresnel-style optics.
- Direct replacements for Peterson 1290A-R light.
- Amber diodes on top, red diodes below.
- Light appears clear when unlit.
- Compliant to ECE/ADR requirements for all functions, mounted vertically or horizontally.
- Convenient, low-profile surface mounting.
- Sealed lens and housing meets IP67 ingress protection level.
- 100,000 hour rated life.
- 2 metre (78") sheathed wires.



1290-09

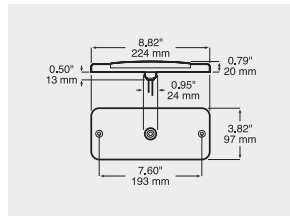

Order No.	Description	Pack	Std Carton
2290A-R	amber & red, 40 diode	poly pack	6
M2290A-R	amber & red, 40 diode	mfg. pack	12
1290-09	black mounting bracket	mfg. pack	1
1290-24	optional mounting gasket	box	20

## 2291A-R LED ECE Compliant Combination Stop, Rear Turn & Tail Light



- Updated lens design with new Fresnel-style optics.
- Direct replacements for Peterson 1291A-R light.
- Amber diodes on top, red diodes below.
- Light appears clear when unlit.
- Compliant to ECE/ADR requirements for all functions, mounted vertically or horizontally.
- Convenient, low-profile surface mounting.
- Sealed lens and housing meets IP67 ingress protection level.
- 100,000 hour rated life.
- 2 metre (78") sheathed wires.

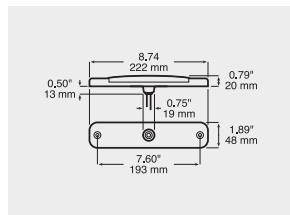

Order No.	Description	Pack	Std Carton
2291A-R	amber & red, slimline	poly pack	6
M2291A-R	amber & red, slimline	mfg. pack	24



## 2291F-C LED ECE Compliant Combination Reverse & Rear Fog Light

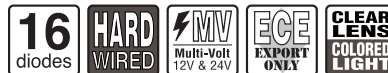

- Advanced lens design with Fresnel-style optics.
- Designed to compliment 2290A-R / 2291A-R.
- Light appears clear when unlit.
- Compliant to ECE/ADR requirements for all functions, mounted vertically or horizontally.
- Convenient, low-profile surface mounting.
- Sealed lens and housing meets IP67 ingress protection level.
- 100,000 hour rated life.
- 2 metre (78") sheathed wires.

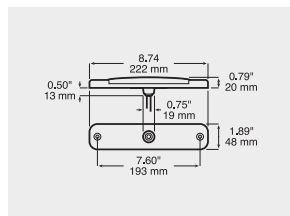

Order No.	Description	Pack	Std Carton
2291F-C	white reverse & red fog	poly pack	6
M2291F-C	white reverse & red fog	mfg. pack	24

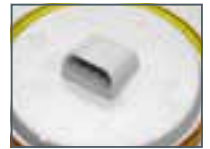

## 1217-9/1218-9 LumenX® LED ECE Compliant Round Stop/Turn/Tail Light



- White diodes and advanced optics fully illuminate red lens.
- AMP-compatible connector integrated into housing.
- Regulated design provides voltage protection and consistent output.
- Multi-volt design is compatible with both 12 and 24 volt systems.
- Kits include light and plug. 1217KR-9 also includes grommet.
- Sealed lens and housing meets IP67 ingress level.
- Grommet version fits 114 mm hole in material up to 6 mm.
- See pages 184–185 & 187 for mounting options.

Order No.	Description	Pack	Std Carton
1217KR-9	<b>KIT</b> red kit, grommet mount	poly pack	6
1218KR-9	<b>KIT</b> red kit, flange mount	poly pack	6
1217R-9	red, grommet mount	poly pack	6
1218R-9	red, flange mount	poly pack	6
426-18	rubber grommet	poly pack	12
B426-18	rubber grommet	mfg. pack	100
417-49	hardshell plug	poly pack	6
B417-49	hardshell plug	mfg. pack	100
817-49	molded plug	poly pack	12
B817-49	molded plug	mfg. pack	100

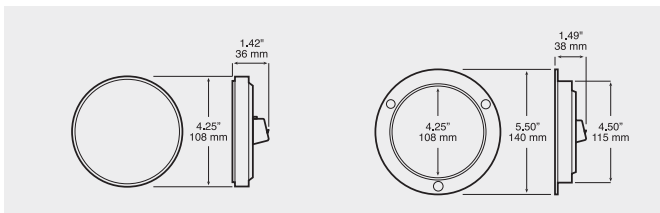

## 1217-9/1218-9 LumenX® LED ECE Compliant Round Turn Signal Light



- White diodes and advanced optics fully illuminate red lens.
- AMP-compatible connector integrated into housing.
- Regulated design provides voltage protection and consistent output.
- Multi-volt design is compatible with both 12 and 24 volt systems.
- Kits include light and plug. 1217KA-9 also includes grommet.
- Sealed lens and housing meets IP67 ingress level.
- Grommet version fits 114 mm hole in material up to 6 mm.
- See pages 184–185 & 187 for mounting options.

Order No.	Description	Pack	Std Carton
1217KA-9	<b>KIT</b> amber kit, grommet mount	poly pack	6
1218KA-9	<b>KIT</b> amber kit, flange mount	poly pack	6
1217A-9	amber, grommet mount	poly pack	6
1218A-9	amber, flange mount	poly pack	6
426-18	rubber grommet	poly pack	12
B426-18	rubber grommet	mfg. pack	100
417-48	hardshell plug	poly pack	6
B417-48	hardshell plug	mfg. pack	100
817-48	molded plug	poly pack	12
B817-48	molded plug	mfg. pack	100

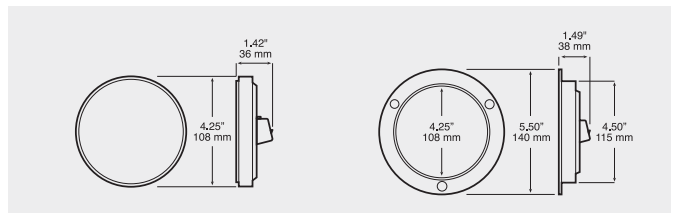

STT

TURN

MARKER

B-U/UTIL

SPEC

EMERG

ECE

MOUNT

ELECT

REFLECT

ACCY

MERCH

TECH

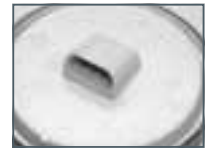

## 1217-9/1218-9 LumenX® LED ECE Compliant Round Reverse Light



- White diodes fully illuminate advanced optics lens.
- AMP-compatible connector integrated into housing.
- Regulated design provides voltage protection and consistent output.
- Multi-volt design is compatible with both 12 and 24 volt systems.
- Kits include light and plug. 1217KC-9 also includes grommet.
- Sealed lens and housing meets IP67 ingress level.
- Grommet version fits 114 mm hole in material up to 6 mm.
- See pages 184–185 & 187 for mounting options.

Order No.	Description	Pack	Std Carton
1217KC-9	<b>KIT</b> white kit, grommet mount	poly pack	6
1218KC-9	<b>KIT</b> white kit, flange mount	poly pack	6
1217C-9	white, grommet mount	poly pack	6
1218C-9	white, flange mount	poly pack	6
426-18	rubber grommet	poly pack	12
B426-18	rubber grommet	mfg. pack	100
417-48	hardshell plug	poly pack	6
B417-48	hardshell plug	mfg. pack	100
817-48	molded plug	poly pack	12
B817-48	molded plug	mfg. pack	100

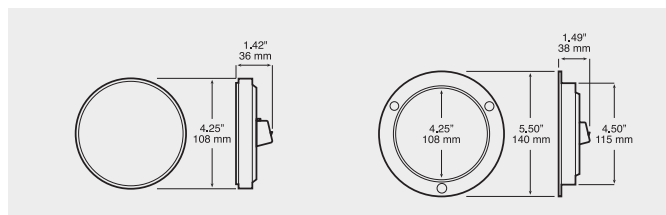

## 1217-9 / 1218-9 LED ECE Compliant Round Rear Fog Light



- Replaces part nos. 1217F & 1218F.
- 108 mm (4-1/4") round rear fog light.
- Certified to meet ECE requirements.
- Does not require "top" positioning.
- Sealed lens and housing meets IP67 ingress level.
- Multi-volt design is compatible with both 12 and 24 volt systems.
- Grommet fits 114 mm hole in material up to 6 mm.
- See pages 184–185 & 187 for mounting options.

Order No.	Description	Pack	Std Carton
1217F-9	clear w/ red diodes	poly pack	6
1218F-9	clear w/ red diodes, flange mnt.	poly pack	6
426-18	rubber grommet	poly pack	12
B426-18	rubber grommet	mfg. pack	100
417-48	hardshell plug	poly pack	6
B417-48	hardshell plug	mfg. pack	100
817-48	molded plug	poly pack	12
B817-48	molded plug	mfg. pack	100

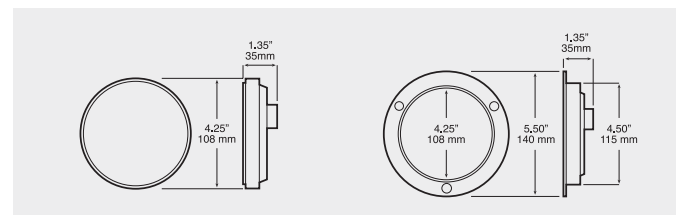



Clear lens with clear diodes that light up red and amber.



Clear lens with clear diodes that light up red and white.

## 1217A-R/1218A-R LED ECE Compliant Combination Stop, Rear Turn & Tail Light

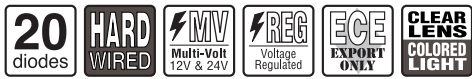

- 108 mm (4-1/4") round rear combination light.
- Turn function in upper half, tail and stop functions in lower half.
- Clear lens with clear diodes that light up amber and red.
- Certified to meet ECE requirements for all functions.
- Sealed lens and housing meets IP67 ingress level.
- Multi-volt design is compatible with both 12 and 24 volt systems.
- Available in grommet mount or flange mount version.
- Grommet version fits 114 mm hole in material up to 6 mm.
- See pages 184–185 & 187 for mounting options.

Order No.	Description	Pack	Std Carton
1217A-R	combo, grommet mt., 2m leads	mfg. pack	50
1217A-R-SW	combo, grommet mt., 12" leads	mfg. pack	50
1218A-R	combo, flange mount, 2m leads	mfg. pack	50
1218A-R-SW	combo, flange mount, 12" leads	mfg. pack	50
426-18	rubber grommet	poly pack	12
B426-18	rubber grommet	mfg. pack	100

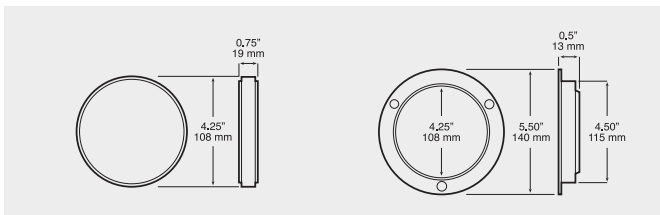

## 1217F-C LED ECE Compliant Combination Reverse & Rear Fog Light

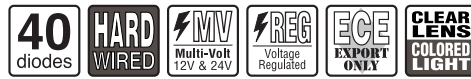

- 108 mm (4-1/4") round rear combination light.
- Rear fog function in upper half, reverse function in lower half.
- Clear lens with clear diodes that light up red and white.
- Certified to meet ECE requirements for all functions.
- Sealed lens and housing meets IP67 ingress protection level.
- Multi-volt design is compatible with both 12 and 24 volt systems.
- Hardwired design features 12" (300 mm) leads.
- Grommet version fits 114 mm hole in material up to 6 mm.
- See pages 184–185 & 187 for mounting options.

Order No.	Description	Pack	Std Carton
1217F-C	red/white combo	mfg. pack	50
1218F-C	red/white combo, flange mount	mfg. pack	50
426-18	rubber grommet	poly pack	12
B426-18	rubber grommet	mfg. pack	100

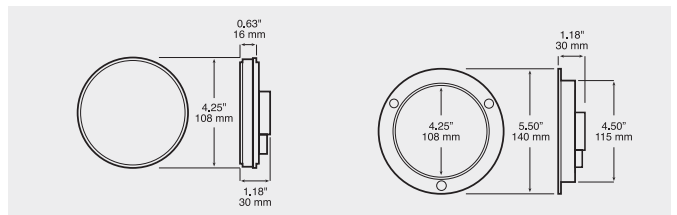

STT
TURN
MARKER
B-U/UTIL
SPEC
EMERG
<b>ECE</b>
MOUNT
ELECT
REFLECT
ACCY
MERCH
TECH



## 2217A-R/2218A-R/2219A-R LED ECE Compliant Combination Stop, Rear Turn & Tail Light



- 108 mm (4-1/4") round rear combination light.
- Turn function in center, tail and stop functions in outer ring.
- Certified to meet ECE requirements for all functions.
- Sealed lens and housing meets IP67 ingress protection level.
- Multi-volt design is compatible with both 12 and 24 volt systems.
- Hardwired design features 12" (300 mm) leads.
- Grommet version fits 114 mm hole in material up to 6 mm.

Order No.	Description	Pack	Std Carton
2217A-R	red/amber combo, grommet mt.	mfg. pack	50
2218A-R	red/white combo, flange mount	mfg. pack	50
2219A-R	red/white combo, stud mount	mfg. pack	50
426-18	rubber grommet	poly pack	12
B426-18	rubber grommet	mfg. pack	100



2219A-R features two mounting studs on rear

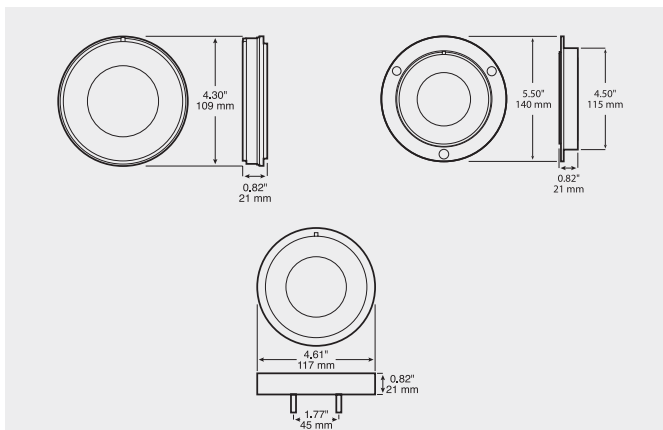

## 2217F-C/2218F-C/2219F-C LED ECE Compliant Combination Reverse & Rear Fog Light



- 108 mm (4-1/4") round rear combination light.
- Reverse function in center, rear fog function in outer ring.
- Certified to meet ECE requirements for all functions.
- Sealed lens and housing meets IP67 ingress protection level.
- Multi-volt design is compatible with both 12 and 24 volt systems.
- Hardwired design features 12" (300 mm) leads.
- Grommet version fits 114 mm hole in material up to 6 mm.

Order No.	Description	Pack	Std Carton
2217F-C	red/white combo, grommet mount	mfg. pack	50
2218F-C	red/white combo, flange mount	mfg. pack	50
2219F-C	red/white combo, stud mount	mfg. pack	50
426-18	rubber grommet	poly pack	12
B426-18	rubber grommet	mfg. pack	100



2219F-C features two mounting studs on rear

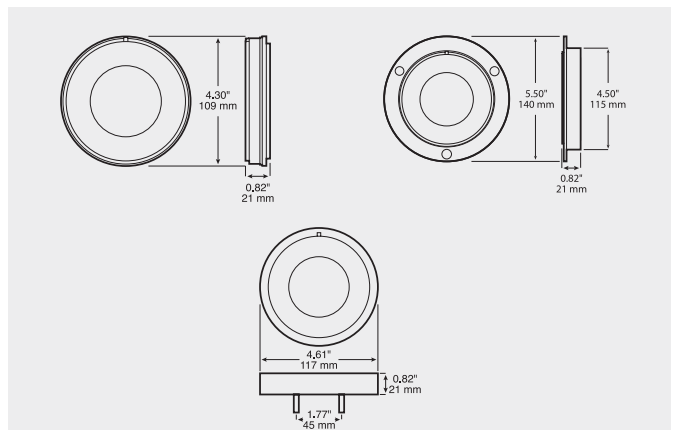

# LED OVAL LIGHTS

# ECE COMPLIANT LIGHTING

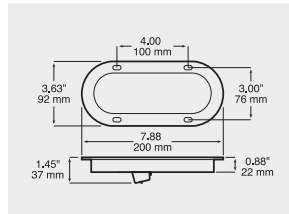
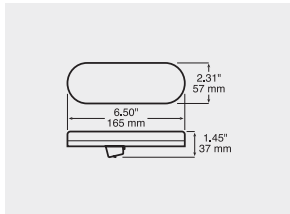

## 1220/1223 LumenX® LED ECE Compliant Oval Tail & Stop Light



- Certified to meet ECE requirements in horizontal or vertical position.
- AMP-compatible connector integrated into housing.
- Multi-volt design is compatible with both 12 and 24 volt systems.
- Kits include light and plug. 1220KR-10 also includes grommet.
- Sealed lens and housing meets IP67 ingress level.
- Grommet version fits material up to 6 mm.

Order No.	Description	Pack	Std Carton
1220KR-10	<b>KIT</b> red kit, grommet	poly pack	6
1223KR-10	<b>KIT</b> red kit, flange mount	poly pack	6
1220R-10	red, grommet	poly pack	6
1223R-10	red, flange	poly pack	6
B421-18	rubber grommet	mfg. pack	100
B417-49	hardshell plug	mfg. pack	100

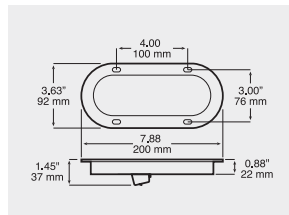
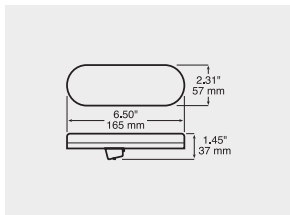

## 1220/1223 LumenX® LED ECE Compliant Oval Front Turn Signal Light



- Certified to meet ECE requirement for front & rear turn indicator when mounted in vertical or horizontal orientation.
- Integrated AMP-compatible receptacle, meets IP67 ingress level
- Multi-volt design is compatible with both 12 and 24 volt systems.
- Kits include light and plug. 1220KA-10 also includes grommet.
- Grommet version fits material up to 6 mm.

Order No.	Description	Pack	Std Carton
1220KA-10	<b>KIT</b> amber kit, grommet	poly pack	6
1223KA-10	<b>KIT</b> amber kit, flange	poly pack	6
1220A-10	amber, grommet	poly pack	6
1223A-10	amber, flange	poly pack	6
B421-18	rubber grommet	mfg. pack	100
B417-48	hardshell plug, 2-wire	mfg. pack	100

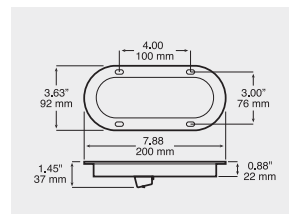
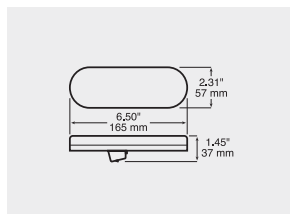

## 1220/1223 LumenX® LED ECE Compliant Oval Reverse Light



- Certified to meet ECE requirement for reverse light function when mounted in vertical or horizontal orientation.
- Integrated AMP-compatible receptacle, meets IP67 ingress level
- Multi-volt design is compatible with both 12 and 24 volt systems.
- Kits include light and plug. 1220KC-10 also includes grommet.
- Grommet version fits material up to 6 mm.

Order No.	Description	Pack	Std Carton
1220KC-10	<b>KIT</b> white kit, grommet mount	poly pack	6
1223KC-10	<b>KIT</b> white kit, flange mount	poly pack	6
1220C-10	white, grommet mount	poly pack	6
1223C-10	white, flange mount	poly pack	6
B421-18	rubber grommet	mfg. pack	100
B417-48	hardshell plug, 2-wire	mfg. pack	100



Shown with B423-11 chrome bezel installed, available separately.

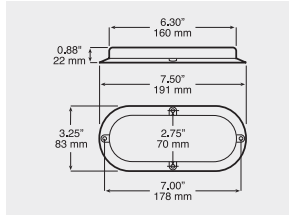

## 1223-4 LED ECE Compliant Surface Mount Rear Tail & Stop Light

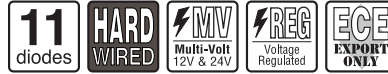

- Oval design w/ black surface-mount housing & optional chrome bezel.
- Certified to meet ECE requirements in horizontal or vertical position.
- Sealed lens and housing meets IP67 ingress level.
- Multi-volt design is compatible with both 12 and 24 volt systems.
- Hardwired design with 8" lead wires.
- Convenient surface mounting with four screws.
- See matching amber rear turn signal below.
- Attractive chrome bezel available separately.

Order No.	Description	Pack	Std Carton
1223R-4	red tail & stop	mfg. pack	50
423-11	chrome bezel	poly pack	12
B423-11	chrome bezel	mfg. pack	50



Shown with B423-11 chrome bezel installed, available separately.

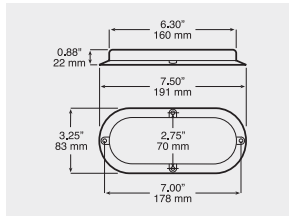

## 1223-4 LED ECE Compliant Surface Mount Rear Turn Signal Light



- Oval design w/ black surface-mount housing & optional chrome bezel.
- Certified to meet ECE requirements in horizontal or vertical position.
- Sealed lens and housing meets IP67 ingress level.
- Multi-volt design is compatible with both 12 and 24 volt systems.
- Hardwired design with 8" lead wires.
- Convenient surface mounting with four screws.
- See matching red rear stop and tail light above.
- Attractive chrome bezel available separately.

Order No.	Description	Pack	Std Carton
1223A-4	amber rear turn signal	mfg. pack	50
423-11	chrome bezel	poly pack	12
B423-11	chrome bezel	mfg. pack	50

Clear lens with clear diodes that light up red and amber.



Shown with B423-11 chrome bezel installed, available separately.

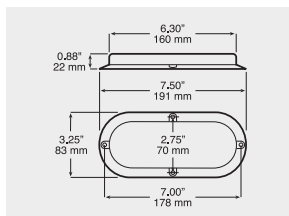

## 1223 LED ECE Compliant Surface Mount Combination Stop, Rear Turn & Tail Light

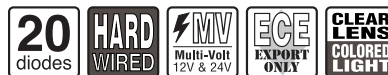

- Oval design w/ black surface-mount housing & optional chrome bezel.
- Clear lens with clear diodes that light up red and amber.
- Certified to meet ECE requirements for all functions in horizontal or vertical position.
- Sealed lens and housing meets IP67 ingress level.
- Multi-volt design is compatible with both 12 and 24 volt systems.
- Hardwired design with 8" lead wires.
- Convenient surface mounting with four screws.
- See matching red rear stop and tail light above.

Order No.	Description	Pack	Std Carton
1223A-R-MV	red/amber combo, multi-volt	mfg. pack	50
423-11	chrome bezel	poly pack	12
B423-11	chrome bezel	mfg. pack	50



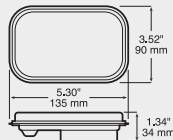

## 850R LED ECE Compliant Rectangular Tail & Stop Light



- Certified to meet both FMVSS 108 (USA) & ECE (European) requirements in horizontal or vertical position.
- Available with 12" or 2 meter (6½-ft.) hardwired leads.
- Sealed lens and housing meets IP67 ingress protection level.
- Multi-volt design is compatible with both 12 and 24 volt systems.
- 850R-1P has hardwired PL3 plug.
- Grommet fits material up to 6 mm.
- Also fits surface-mount cluster pods. See page 189.

Order No.	Description	Pack	Std Carton
P850R-1	red, 12" leads	poly pack	6
850R	red, 2 meter leads	mfg. pack	10
850R-1	red, 12" leads	mfg. pack	10
850R-1P	red, 10" leads w/ plug	mfg. pack	10
850-18	rubber grommet	poly pack	12
B850-18	rubber grommet	mfg. pack	50

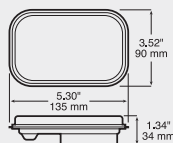

## 850A LED ECE Compliant Rectangular Rear Turn Signal Light



- Certified to meet ECE requirements in horizontal or vertical position.
- Available with 12" or 2 meter (6½-ft.) hardwired leads.
- Sealed lens and housing meets IP67 ingress protection level.
- Multi-volt design is compatible with both 12 and 24 volt systems.
- Potted, hardwired terminals for durability.
- 850A-1P has hardwired PL3 plug.
- Grommet fits material up to 6 mm.
- Also fits surface-mount cluster pods. See page 189.

Order No.	Description	Pack	Std Carton
P850A-1	amber, 12" leads	poly pack	6
850A	amber, 2 meter leads	mfg. pack	10
850A-1	amber, 12" leads	mfg. pack	10
850A-1P	amber, 10" leads w/ plug	mfg. pack	10
850-18	rubber grommet	poly pack	12
B850-18	rubber grommet	mfg. pack	50

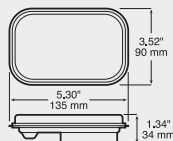

## 850F LED ECE Compliant Rectangular Rear Fog Light



- Certified to meet ECE requirements in horizontal or vertical position.
- Sealed lens and housing meets IP67 ingress protection level.
- Multi-volt design is compatible with both 12 and 24 volt systems.
- Equipped with 12" (300 mm) sheathed leads.
- Grommet fits material up to 6 mm.
- Also fits surface-mount cluster pods. See page 189.

Order No.	Description	Pack	Std Carton
850F-SW	clear lens with red diodes	mfg. pack	10
850-18	rubber grommet	poly pack	12
B850-18	rubber grommet	mfg. pack	50

STT  
TURN  
MARKER  
B-U/UTIL  
SPEC  
EMERG  
ECE  
MOUNT  
ELECT  
REFLECT  
ACCY  
MERCH  
TECH



Clear lens with diodes that light up red and amber.

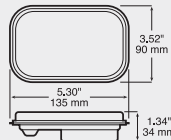

## 851A-R LED ECE Compliant Combination Stop, Rear Turn & Tail Light



- Turn function in upper half, tail and stop functions in lower half.
- Clear lens with diodes that light up red and amber.
- Certified to meet ECE requirements for all functions.
- Sealed lens and housing meets IP67 ingress protection level.
- Multi-volt design is compatible with both 12 and 24 volt systems.
- Available with 12" or 2 meter (6½-ft.) hardwired leads.
- Also fits surface-mount cluster pods. See page 189.

Order No.	Description	Pack	Std Carton
P851A-R-SW	amber/red combo, 12" leads	poly pack	6
851A-R	amber/red combo, 2m leads	mfg. pack	10
851A-R-SW	amber/red combo, 12" leads	mfg. pack	10
850-18	rubber grommet	poly pack	12
B850-18	rubber grommet	mfg. pack	50



Clear lens with clear diodes that light up red and white.

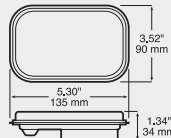

## 851F-C LED ECE Compliant Combination Reverse & Rear Fog Light

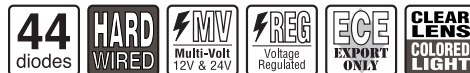

- Rear fog function in upper half, reverse function in lower half.
- Clear lens with diodes that light up red and white.
- Certified to meet ECE requirements in vertical position.
- Sealed lens and housing meets IP67 ingress protection level.
- Multi-volt design is compatible with both 12 and 24 volt systems.
- Equipped with 12" sheathed leads.
- Also fits surface-mount cluster pods. See page 189.

Order No.	Description	Pack	Std Carton
851F-C-SW	red, white combo	mfg. pack	10
850-18	rubber grommet	poly pack	12
B850-18	rubber grommet	mfg. pack	50

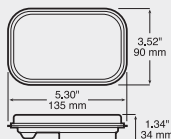

## 850C LED ECE+DOT Compliant Rectangular Reverse Light

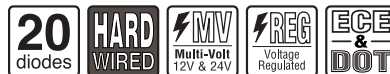

- 2 versions available for either horizontal or vertical mounting.
- Meets DOT & ECE requirements when mounted as specified.
- Multi-volt design is compatible with both 12 and 24 volt systems.
- Available with 12" or 2 meter (6½-ft.) hardwired leads.
- 850C-1P has hardwired PL3 plug.
- Also fits surface-mount cluster pods. See page 189.

Order No.	Description	Pack	Std Carton
P850C-1	vertical, 12" leads	poly pack	6
850C	vertical, 2m leads	mfg. pack	10
850C-1	vertical, 12" leads	mfg. pack	10
850C-1P	vertical, 12" leads, with plug	mfg. pack	10
850C-AMP	vertical, with AMP shroud	mfg. pack	10
850HC-1	horizontal, 12" leads	mfg. pack	10
850-18	rubber grommet	poly pack	12
B850-18	rubber grommet	mfg. pack	50

# LED OUTLINE & MARKER LIGHTS



1200-09H

B1200-09X bezel

Optional mounting bracket and chrome bezel are shown with 1200A lights installed; sold separately.

## 1200 LED ECE Compliant Oval Side Marker/Outline Lights w/ Reflex



- Low-profile, sealed design with integral reflex function.
- 1200C has two diodes, 1200A and 1200R have three diodes.
- Certified to applicable ECE regulations.
- Side marker meets ECE regulations mounted horizontally or vertically.
- Multi-volt design is compatible with both 12 and 24 volt systems.
- Meets IP67 ingress protection level.
- Hardwired design has 12" (300mm) sheathed leads.
- See page 190 for bracket and bezel dimensions.

Order No.	Description	Pack	Std Carton
P1200A	amber side marker	poly pack	12
P1200C	white front outline marker	poly pack	12
P1200R	red rear outline marker	poly pack	12
1200A	amber side marker	mfg. pack	50
1200A-AMP	amber w/ AMP shroud	mfg. pack	50
1200C	white front outline marker	mfg. pack	50
1200C-AMP	white w/ AMP shroud	mfg. pack	50
1200R	red rear outline marker	mfg. pack	50
1200R-AMP	red w/ AMP shroud	mfg. pack	50
1200-09H	horizontal mount bracket	mfg. pack	400
1200-09X	chrome bezel	poly pack	12
B1200-09X	chrome bezel	mfg. pack	50

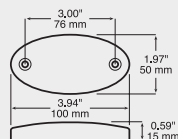

# ECE COMPLIANT LIGHTING



## 1203 LED ECE+DOT Compliant Marker & Outline Lights w/Integral Reflex



- LED marker lights feature 3 diodes and integral reflex.
- Red and amber lights meet both ECE and DOT requirements.
- White light certified to meet ECE front outline marker standard.
- Mounts on 4.5" centers to any flat, vertical surface.
- Hardwired design has 12" (300mm) sheathed leads.
- "-PKD" versions have Packard-compatible hardshell connector.
- 9-32 volt operating range.

Order No.	Description	Pack	Std Carton
P1203A	amber side marker	poly pack	12
P1203C	white front outline marker	poly pack	12
P1203R	red rear outline marker	poly pack	12
1203A	amber, stripped leads	mfg. pack	50
1203A-PKD	amber w/ hardshell connector	mfg. pack	50
1203C	white front outline marker	mfg. pack	50
1203C-PKD	white w/ hardshell connector	mfg. pack	50
1203R	red rear outline marker	mfg. pack	50
1203R-PKD	red w/ hardshell connector	mfg. pack	50

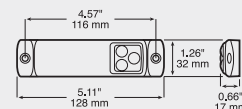

STT

TURN

MARKER

B-U/UTIL

SPEC

EMERG

ECE

MOUNT

ELECT

REFLECT

ACCY

MERCH

TECH



1268R-MV mounted in 168-10 bezel

## 1268 Series LED ECE Compliant Side Marker/Outline Lights



- Equipped with two diodes except 1268A-MTC, which has four.
- Multi-volt design is compatible with both 12 and 24 volt systems.
- Certified to applicable ECE and ADR regulations.
- 1268A-MTC meets ECE Reg 6, Cat 5 for supplementary side direction indicator and comes equipped with 2.5 meter leads.
- Hardwire design features sheathed, stripped leads.
- 168-09 bracket mounts 1268-series lights on 1.125" (29 mm) centers.
- See pages 178–179 for bracket and bezel dimensions.

Order No.	Description	Pack	Std Carton
P1268A-MV	amber, 2 m leads	poly pack	12
P1268A-MVC	amber w/clear lens, 2 m leads	poly pack	12
P1268R-MV	red, 2 m leads	poly pack	12
P1268R-MVC	red w/clear lens, 2 m leads	poly pack	12
P1268W-MV	white lens, 2 m leads	poly pack	12
1268A-MV	amber, 2 m leads	mfg. pack	50
1268A-MVC	amber w/clear lens, 2 m leads	mfg. pack	50
1268A-MVC-BT2	amber w/ clr lens, .180 bullets	mfg. pack	50
1268A-MTC	amber w/clear lens, 2.5 m	mfg. pack	50
1268R-MV	red, 2 m leads	mfg. pack	50
1268R-MVC	red w/clear lens, 2 m leads	mfg. pack	50
1268W-MV	white lens, 2 m leads	mfg. pack	50
168-09	bracket, black	poly pack	12
168-092K	<b>KIT</b> alum. brush guard & gasket kit	poly pack	12
168-10K	<b>KIT</b> chrome bezel & gasket kit	poly pack	12
168-18	mounting gasket	poly pack	12
B168-09	bracket, black	mfg. pack	100
B168-092	<b>KIT</b> alum. brush guard & gasket kit	mfg. pack	100
B168-10	chrome bezel	mfg. pack	100
B168-18	gasket for use w/o bracket	mfg. pack	100
B168-181	gasket for use with B168-092	mfg. pack	100
B168-182	gasket for use with B168-10	mfg. pack	100

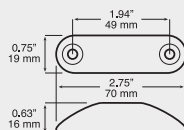

LED With Clear Lens  
Lights Up Half Red and  
Half Amber



## 2268 LED ADR Compliant Combination Side Marker Light



- **Certified to applicable ADR (Australian Design Rules) regulations. NOT ECE COMPLIANT**
- Welded rear housing, advanced surface-mount diodes, and more precise separation between red and amber illumination.
- Amber and red diodes behind clear lens
- Low profile, narrow surface-mount design suits narrow rails.
- Meets IP67 ingress rating.
- Hardwired design features 18-gauge leads.
- 2268A-R-MV has 2.5 meter leads. 2268A-R-MV-BT2 has 200 mm leads.
- Flat-wire sheathed cable for simplified crimp connections, less bulk.
- Multiple mounting hardware options.
- Multi-volt design is compatible with both 12 and 24 volt systems.
- Recommended fastening: 4 mm screw.
- 168-09 bracket mounts 2268 lights on 1.125" (29 mm) centers.
- See pages 178–179 for bracket and bezel dimensions.

Order No.	Description	Pack	Std Carton
P2268A-R-MV	2.5 m / 98.5" stripped leads	poly pack	12
P2268A-R-MV-BT2	200 mm / 8", .180 bullets.	poly pack	12
2268A-R-MV	2.5 m / 98.5" stripped leads	mfg. pack	50
2268A-R-MV-BT2	200 mm / 8", .180 bullets.	mfg. pack	50
B168-09	bracket, black	mfg. pack	100
B168-092	<b>KIT</b> alum. brush guard & gasket kit	mfg. pack	100
B168-10	chrome bezel	mfg. pack	100
B168-181	gasket for use with B168-092	mfg. pack	100
B168-182	gasket for use with B168-10	mfg. pack	100
B2268-18	gasket for use w/o bracket	mfg. pack	100

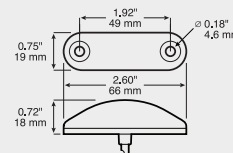

STT

TURN

MARKER

B-U/UTIL

SPEC

EMERG

ECE

MOUNT

ELECT

REFLECT

ACCY

MERCH

TECH

## 106 Chrome Guard



- Accessorizes 38, 108, 130, and 138 series lights.
- Sturdy die-cast guard provides added protection for oblong lights.
- Chrome plated for beauty and durability.
- Fits most PM oblong lights as well as competitive models.

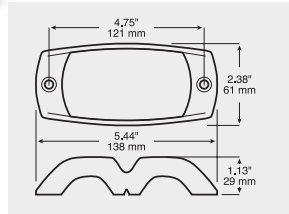

Order No.	Description	Pack	Std Carton
V106-09	chrome	Viz Pack	6
B106-09	chrome	mfg. pack	60

## 127 Flush Mount Grommet

- Flush mounts 127 and 129 clearance light to vehicle.
- Recommended hole size for 1/8" thick plate: 3.5" x 2.4" with 7/16" radius corners.
- Requires 142-49 or B142-49 plug for incandescent light installation.

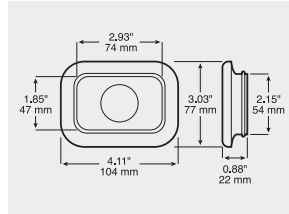

Order No.	Description	Pack	Std Carton
127-18	black	poly pack	24
B127-18	black	mfg. pack	100

## 133 Chrome Bezel

- Fits 133 clearance light to vehicle.
- Attractive chrome finish.
- Mounts on 3" centers.

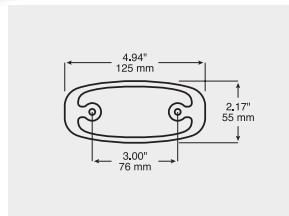

Order No.	Description	Pack	Std Carton
B133-10	chrome	mfg. pack	50

## 142 Surface Mount Bracket for 2 1/2" Round Lights



- Allows grommet-mount 2.5" clearance / marker lights to be surface mounted
- Branch deflector design protects light unit.
- Constructed of UV and corrosion resistant plastic
- Available in gray or black.
- Requires 143-18 or 144-18 grommet to complete installation.

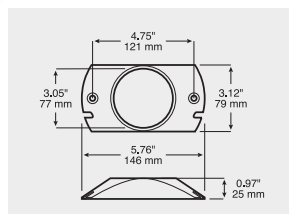
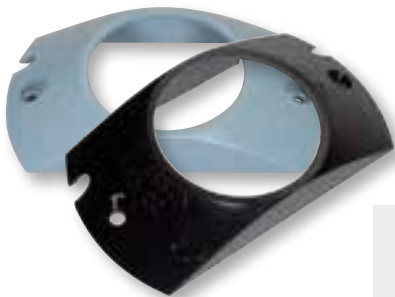

Order No.	Description	Pack	Std Carton
142-09	gray	poly pack	12
B142-091	black	mfg. pack	100

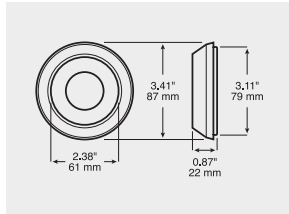

## 142

### 2 1/2" Edge Mount Grommet

- Provides edge mounting of 2 1/2" sealed lights.
- Ideal for mounting PC-rated lights.
- Fits 2 25/32" mounting hole.
- Requires 142-49 plug to complete installation.

Order No.	Description	Pack	Std Carton
B142-17	open back	mfg. pack	100
142-49	plug	poly pack	12
B142-49	plug	mfg. pack	100

## 142

### 2 1/2" Grommet

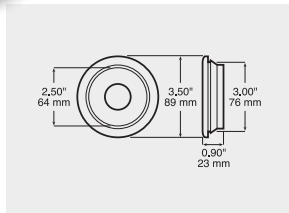

- Allows 2 1/2" diameter sealed units to be flush mounted.
- Fits 72, 142, 143, 162, 163, 192, 193, 196, and 197 series lights.
- Fits 3" mounting hole.
- Installation of lights with PL10 plug requires 142-49 or 162-49 plug.
- Kit contains 142-18 grommet, 142-49 plug and grounding screw.

Order No.	Description	Pack	Std Carton
142-18	open back	poly pack	24
142-18K	<b>KIT</b> open back, kit	poly pack	12
B142-18	open back	mfg. pack	100
142-49	plug	poly pack	12
B142-49	plug	mfg. pack	100

## 143/144

### 2 1/2" Grommet



143-18



144-18

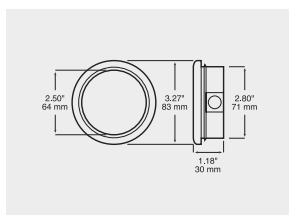

- Mounts 2 1/2" diameter sealed units.
- Fits 72, 142, 143, 162, 163, 173, 175, 192, 193, 196, and 197 series lights.
- Fits 2 25/32" mounting hole.
- Installation of lights with PL10 plug requires 142-49 or 162-49 plug.
- Kit contains 143-18 grommet, 142-49 plug and grounding screw.
- Closed back unit is recommended for open installations where splash plate is not used.

Order No.	Description	Pack	Std Carton
143-18	open back	poly pack	24
143-18K	<b>KIT</b> open back, kit	poly pack	12
144-18	closed back	poly pack	24
B143-18	open back	mfg. pack	100
B144-18	closed back	mfg. pack	100
142-49	plug	poly pack	12
B142-49	plug	mfg. pack	100

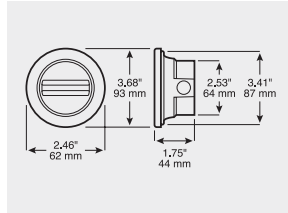

143

## 2 1/2" Closed Back Grommet



- Closed back protects terminals from wheel splash.
- Fits 72, 142, 143, 162, 163, 173, 175, 192, 193, 196, and 197 series lights.
- Fits 3" mounting hole.
- Installation of lights with PL10 plug requires 142-49 or 162-49 plug.
- Easy access side entry for plug.

Order No.	Description	Pack	Std Carton
B143-17	closed back	mfg. pack	100
142-49	plug	poly pack	12
B142-49	plug	mfg. pack	100

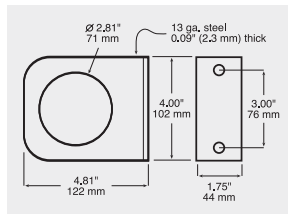

143-092

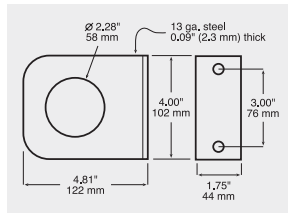

146-092

143/146

## L-Mount Brackets



- Brackets mount either 2-inch diameter or 2.5-inch diameter grommet-mount lights perpendicular to any flat surface.
- Heavy-gauge steel construction.
- Rugged black power coated finish.
- 143-092 accepts 142-18, 143-18 & 144-18 grommets.
- 146-092 accepts 146-18, 146-182 & 146-184 grommets.

Order No.	Description	Pack	Std Carton
143-092	accepts 2.5" lights	mfg. pack	6
146-092	accepts 2" lights	mfg. pack	6

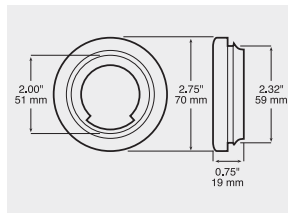

146-18

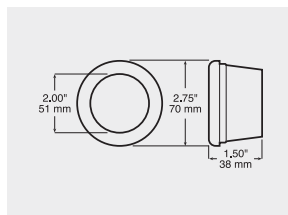

146-182

146

## 2" Grommets



- Allows 2" diameter sealed units to be flush mounted.
- Fits 146, 166, 164, 165, 194, 195, 198, and 199 series lights.
- Fits 2 5/16" mounting hole in panels up to 0.25" thick.
- Installation of lights with PL10 plug requires 142-49 or 162-49 plug.
- Kit includes 146-18 grommet, 142-49 plug and grounding screw.
- Closed back unit is recommended for open installations where splash plate is not used.

Order No.	Description	Pack	Std Carton
146-18	open back	poly pack	24
146-18K	<b>KIT</b> open back, kit	poly pack	12
146-182	closed back	poly pack	24
B146-18	open back	mfg. pack	100
B146-182	closed back	mfg. pack	100
142-49	plug	poly pack	12
B142-49	plug	mfg. pack	100

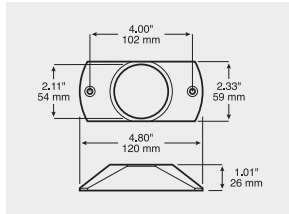

146

## Surface Mount Bracket for 2" Round Lights



- Allows grommet-mount 2" clearance / marker lights to be surface mounted
- Branch deflector design protects light unit.
- Constructed of UV and corrosion resistant plastic.
- Fits 2" diameter round sealed lights.
- Requires 146-181 grommet and appropriate plug for installation.

Order No.	Description	Pack	Std Carton
146-09	gray	poly pack	12
B146-09	gray	mfg. pack	100
B146-093	black	mfg. pack	100
146-181	grommet	poly pack	48
B146-181	grommet	mfg. pack	100
142-49	plug	poly pack	12
B142-49	plug	mfg. pack	100

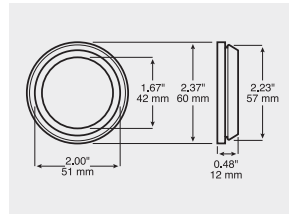

146

## 2" Grommet



- Mounts 2" diameter sealed units in 146-09 surface mount bracket.

Order No.	Description	Pack	Std Carton
146-181	open back	poly pack	48
B146-181	open back	mfg. pack	100



2593

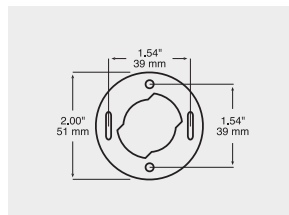

2594

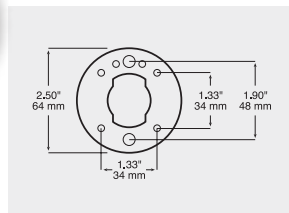

146/142

## Cam-On Surface Mount Brackets

- Allows 2" or 2 1/2" lamps to be surface mounted.
- Stainless steel construction.
- Easy cam-on, cam-off installation for incandescent or LED lights.
- Requires 142-49 or 162-49 plug to complete installation.
- Mounts with two screws.

Order No.	Description	Pack	Std Carton
2593	2" LED & incandescent	mfg. pack	100
2594	2 1/2" LED & incandescent	mfg. pack	100



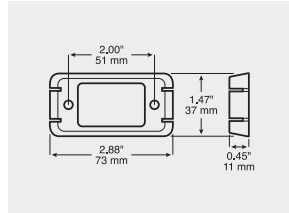
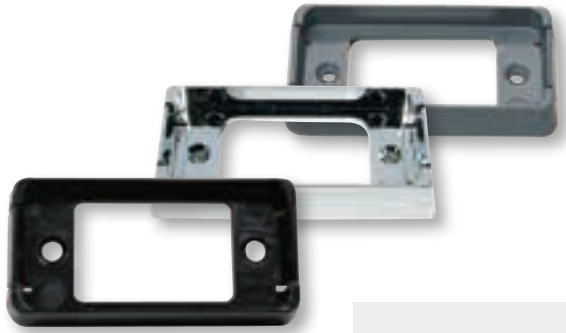

## 150 Mounting Brackets



- Allows 150, 152, and 203 series lights to be surface mounted.
- Gray, chrome or black finish.
- Mounts on 2" centers.
- Requires 142-49 2-wire plug for electrical connection.
- Pack includes bracket, gasket and mounting screws.

Order No.	Description	Pack	Std Carton
150-09	gray	poly pack	12
150-10	chrome	poly pack	12
150-13	black	poly pack	12
142-49	plug w/ 6" leads	poly pack	12
B142-49	plug w/ 6" leads	mfg. pack	100

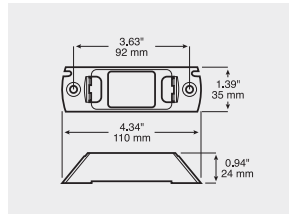

## 150 Surface Mount Bracket



- White ABS construction.
- Allows 150, 153, and 203 series lights to be surface mounted.
- Mounts on 3 5/8" centers.
- 150 and 203 series require 142-49 2-wire plug for electrical connection.
- 153 series require 153-49 plug, except 153C which is hardwired.

Order No.	Description	Pack	Std Carton
150-091	white	poly pack	12
B150-091	white	mfg. pack	50
142-49	plug w/ 6" leads – 150, 203 series	poly pack	12
B142-49	plug w/ 6" leads – 150, 203 series	mfg. pack	100
153-49	plug w/ 6" leads – 153 series	poly pack	12
B153-49	plug w/ 6" leads – 153 series	mfg. pack	100

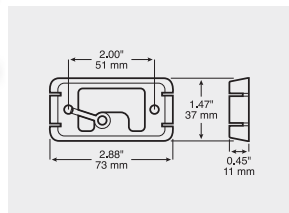
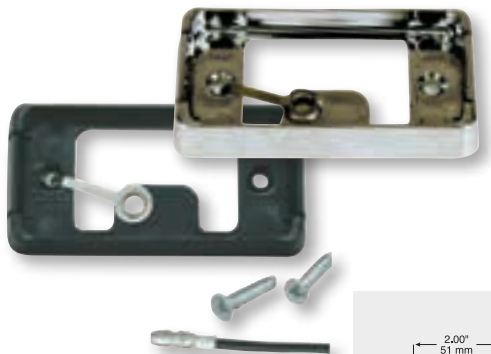

## 150 Chassis Mounting Kits

- Allows 150 series lights to be surface mounted.
- Available in chrome and black.
- Mounts on 2" centers.
- Grounds through mounting hardware.
- Kit includes bracket, gasket, mounting screws and 17" lead wire with .156 bullet terminal.

Order No.	Description	Pack	Std Carton
150-092	black kit	poly pack	12
150-102	chrome kit	poly pack	12
B150-12	chassis/chrome bracket	mfg. pack	100

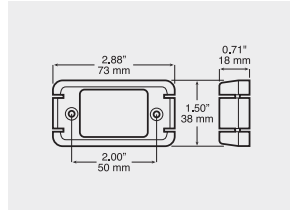

## 150 Surface Mount Bracket



- Allows 153, 203, and 253 series lights to be surface mounted.
- 153 light requires 153-49 plug for installation.
- Also accepts 150 style light with 142-49 plug when vehicle surface is cut out to clear plug.

Order No.	Description	Pack	Std Carton
150-095	black	poly pack	12
B150-095	black	mfg. pack	100



150-18

150-181

## 150 Mounting Grommets

- Allows flush mounting of 150 or 153 series light on metallic or non-metallic surfaces.
- B150-18 also accepts 152 light.
- 150 and 203 series require 142-49 2-wire plug for electrical connection.
- 153 series require 153-49 plug, except 153C which is hardwired.
- Hole spec for 150-18: 2.88" x 1.53" x 11/64" max panel thickness.
- Hole spec for 150-181: 3.00" x 1.65" x 1/4" max panel thickness.
- 153-181 is identical to 150-18, but designed to provide better water sealing.

Order No.	Description	Pack	Std Carton
B150-18	black	mfg. pack	100
B150-181	black	mfg. pack	100
B153-181	black, water sealing	mfg. pack	100
B142-49	6" lead wire – 150, 203 series	mfg. pack	100
B142-50	19" lead wire – 150, 203 series	mfg. pack	100
B142-51	12" lead wire – 150, 203 series	mfg. pack	100
B153-49	6" lead wire – 153 series	mfg. pack	100

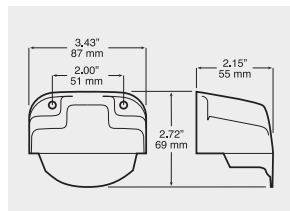
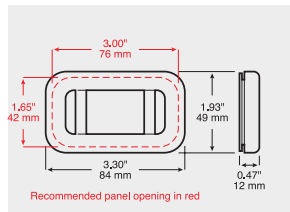
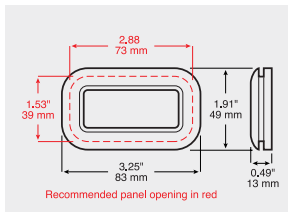

## 150 License/Utility Light Bracket

- High-impact polycarbonate.
- Black or gray.
- 150C, 153C, or 203C light snaps into housing to form single unit.
- Mounts to vertical surfaces.
- Visor hood shields direct light from following vehicles.
- Complies with applicable regulations without need for additional spacers.

Order No.	Description	Pack	Std Carton
150-14	gray	poly pack	24
150-141	black	poly pack	24
B150-14	gray	mfg. pack	100
B150-141	black	mfg. pack	100
142-49	plug	poly pack	12
B142-49	plug	mfg. pack	100

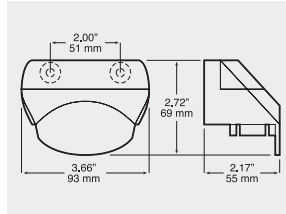
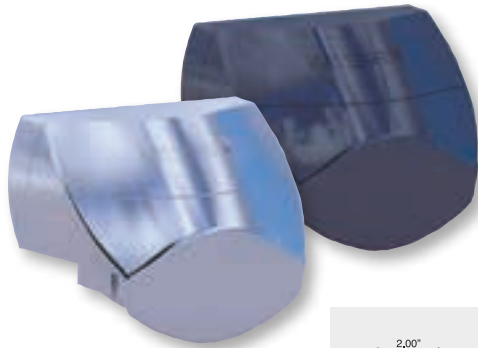

## 150

### License Plate Light Brackets

- All Peterson 150C & 153C series license lights snap in easily.
- Bracket features hidden mounting holes and stylish design.
- Available in gloss black or brilliant chrome finish.
- Mounts to vertical surfaces.
- Visor hood shields direct light from following vehicles.
- Complies with applicable regulations without need for additional spacers.

Order No.	Description	Pack	Std Carton
B150-142	black	mfg. pack	50
B150-143	chrome	mfg. pack	50



154-09K



154-10K



154-11K

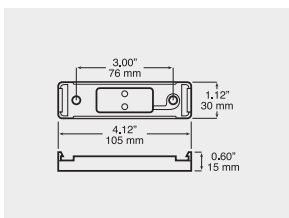

154-09

## 154

### Surface Mount Brackets

- Allows 154 and 161 series lights to be surface mounted.
- Gray, chrome or black finish.
- Mounts on 3" centers.
- Poly pack kits mount to metal surfaces and includes bracket, terminal pad with molded lead wire and mounting screws; grounds through mounting hardware.
- B154-11K-BT1 kit consists of bracket and molded plug assembly terminated with a .180 bullet
- Bracket available without terminal pad and wire; mounts to nonmetallic surfaces with 153-49 two wire plug.

Order No.	Description	Pack	Std Carton
154-09K	<b>KIT</b> gray kit	poly pack	12
154-10K	<b>KIT</b> chrome kit	poly pack	12
154-11K	<b>KIT</b> black kit	poly pack	12
B154-09	gray bracket only	mfg. pack	100
B154-10	chrome bracket only	mfg. pack	100
B154-11	black bracket only	mfg. pack	100
B154-11K	<b>KIT</b> black kit w/o screws	mfg. pack	100
B154-11K-BT1	<b>KIT</b> black kit w/o screws, .180 bullet	mfg. pack	100

## 154

### Stainless Steel Brush Guard

- Corrosion-free stainless steel construction.
- Designed for 154 series.
- Accepts all thinline marker lights that mount on 3" centers or less.

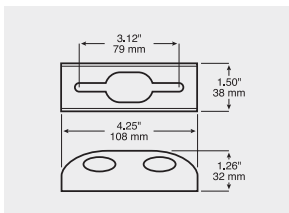

Order No.	Description	Pack	Std Carton
B154-092	guard	mfg. pack	100

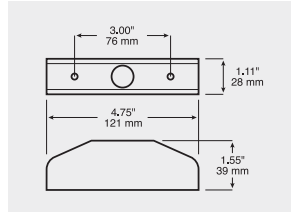
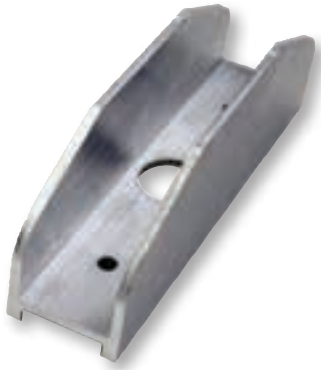

## 160 Aluminum Brush Guard



- Thick, extruded aluminum construction for extra protection.
- Mounts on 3" centers.
- Fits 60 series lights.

Order No.	Description	Pack	Std Carton
160-09	aluminum	poly pack	6
B160-09	aluminum	mfg. pack	120
160-242	mounting gasket for 160-09	mfg. pack	1



**PATENT  
PENDING**

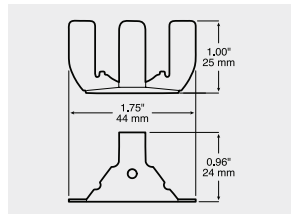

## 162 Plug Retaining Clip



- Stainless steel construction.
- Clips over electrical plug to keep it firmly inserted into light
- Fits 2" or 2 1/2" diameter marker lamps with cam-on mounting.
- Perfect for heavy-vibration applications such as container chassis.

Order No.	Description	Pack	Std Carton
B162-093	aluminum	mfg. pack	100

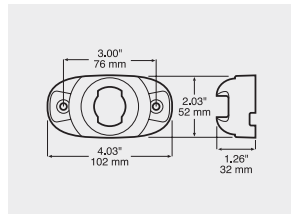

## 165 2" or 2 1/2" Cam-On Mounting Bracket



- Allows 2" or 2 1/2" diameter marker lamps to be surface mounted.
- Plastic deflectors protect lamp from damage.
- Easy cam-on, cam-off lamp installation.
- Fits incandescent and LED lights.
- Allows PC-rated installation.
- Mounts with two screws.

Order No.	Description	Pack	Std Carton
165-10	gray	poly pack	12
B165-10	gray	mfg. pack	100

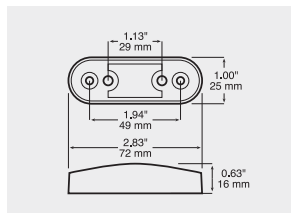

## 168 Surface Mount Bracket

- Enhances appearance of 168, 1268, and 2268 series lights.
- Attractive black finish.
- May also be used to adapt mounting centers from 1.93" to 1.13".
- 168-093 version has the same overall dimensions and construction, but has two snap-on prongs for mounting light to bracket.

Order No.	Description	Pack	Std Carton
168-09	black	poly pack	12
B168-09	black	mfg. pack	100
B168-093	black, snap-in lamp mount	mfg. pack	50

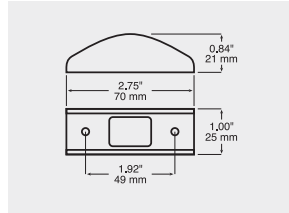

## 168-092

### Aluminum Brush Guard

- Enhances durability and longevity of 168 and 1268 series lights.
- Rugged, stamped aluminum construction for extra protection.
- Black powdercoat version available.
- Requires use of 168-181 thinline mounting gasket.
- 168-092K kit include 168-181 gasket.

Order No.	Description	Pack	Std Carton
168-092K	<b>KIT</b> aluminum w/ 168-181 gasket	poly pack	12
B168-092	aluminum	mfg. pack	50
B168-092B	black powdercoat	mfg. pack	50
B168-181	mounting gasket for 168-092	mfg. pack	100

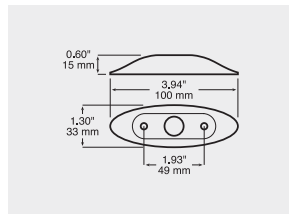

## 168-10

### Decorative Chrome Bezel

- Enhances appearance of 168 and 1268 series lights.
- Attractive chrome finish.
- ABS construction.

Order No.	Description	Pack	Std Carton
168-10K	<b>KIT</b> chrome w/ 168-182 gasket	poly pack	12
B168-10	chrome	mfg. pack	100
B168-182	mounting gasket for 168-10	mfg. pack	100



168-18

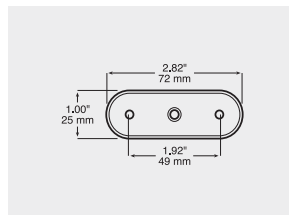

168-181

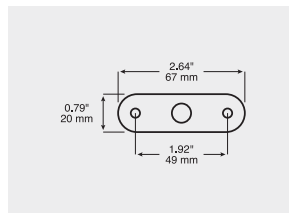

168-182

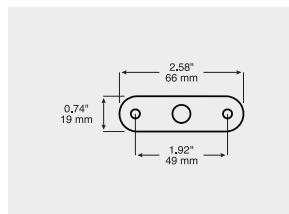

## 168

### Mounting Gasket

- Fits 168 and 1268 LED lights.
- Flexible rubber protects mounting surfaces.
- Use 168-18 when mounting 168 and 1268 light without brush guard or bezel.
- 168-181 for use with 168-092 aluminum brush guard.
- 168-182 for use with 168-10 chrome bezel.
- Use 2268-18 when mounting 2268A-R without bracket

Order No.	Description	Pack	Std Carton
168-18	black rubber	poly pack	12
B168-18	black rubber	mfg. pack	100
B168-181	mounting gasket for 168-092	mfg. pack	100
B168-182	mounting gasket for 168-10	mfg. pack	100
B2268-18	mounting gasket for 2268A-R-MV	mfg. pack	100



2268-18

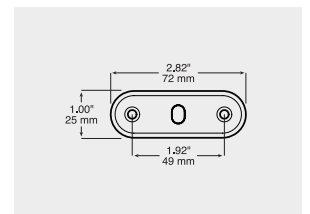

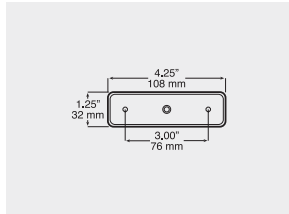

## 169 Mounting Gasket

- Fits 169 series LED lights.
- Flexible rubber protects mounting surfaces.

Order No.	Description	Pack	Std Carton
B169-18	black rubber	mfg. pack	100

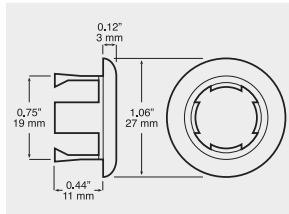

## 176 Mounting Bracket

- Rigid plastic snap-in bracket.
- Designed to mount 171, 176, 177, 181 and 271 series in 0.75" (19 mm) hole.
- Anti-theft feature when used with 176 series lights.
- 176-09X features chrome plating for enhanced appearance.

Order No.	Description	Pack	Std Carton
B176-09	plastic anti-theft bracket, black	mfg. pack	100
B176-09X	plastic anti-theft bracket, chrome	mfg. pack	100



## 177-10 Mounting Bezel



- Designed to fit 171, 176, 177, 181 and 271 series in 0.75" (19 mm) hole.
- 177-10 satin finish steel bezel fits over rubber grommet for durability and enhanced appearance.
- Secured in position between light housing and grommet when installed.

Order No.	Description	Pack	Std Carton
B177-10	satin finish steel bezel	mfg. pack	100

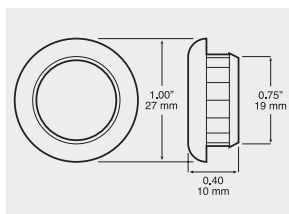

## 177-18 Mounting Grommet



- Designed to mount 171, 176, 177, 181 and 271 series in 0.75" (19 mm) hole.
- 177-18 grommet made of UV-resistant polymer rubber; stays flexible and prevents cracking for extended service life.
- Standard grommet provided with all 3/4" series lights.
- Grommet designed to fit .0179" to .1875" thick panels.

Order No.	Description	Pack	Std Carton
B177-18	rubber grommet, 0.75" dia.	mfg. pack	100

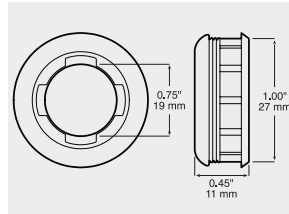

## 177-182

### Grommet for 1" Diameter Mounting Hole



- Designed to fit 171, 176, 177, 181 and 271 series in 1" (25 mm) hole.
- UV-resistant polymer rubber; stays flexible and prevents cracking for extended service life.
- Replaces standard grommet when larger diameter mounting hole is required.
- Grommet designed to fit 26 gauge steel to 1/4" thick panel (.0179" – .25")

Order No.	Description	Pack	Std Carton
B177-182	rubber grommet, 1" dia.	mfg. pack	100



Shown with light installed;  
sold separately



## 176-092 / 176-093

### Channel-Mount Bracket

- Fits Peterson 171, 176, 177, 181, 186, 271 and 286 series LED lights.
- Rubber grommet required for installation.
- Corrosion-resistant aluminum alloy construction for extra durability.
- Mounts on 3" centers with two screws or bolts. Hardware not included.
- Channel dimensions:

Min. Width	Max. Depth
1.13"	@ 1.30"
1.00"	@ 1.15"
0.65"	@ 0.83"

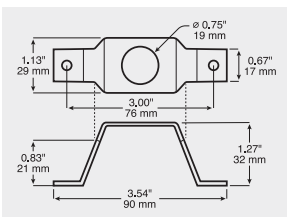

176-092

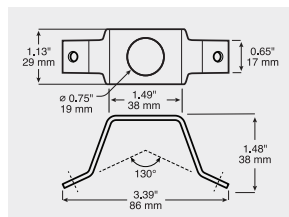

176-093

Order No.	Description	Pack	Std Carton
176-092	for flat surfaces	poly pack	6
176-093	for curved surfaces	poly pack	6
B176-092	for flat surfaces	mfg. pack	100
B176-093	for curved surfaces	mfg. pack	100



176-10

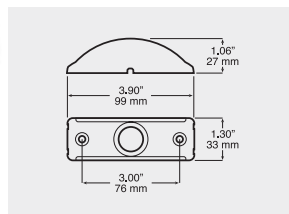

176-13

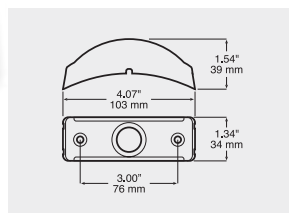

## 176-10 / 176-13

### Surface Mount Bracket & Brush Guard

- Surface mounts 171, 176, 177, 181 and 271 series lights.
- Use of 177-18 grommet (provided with all 3/4" series lights) is required for mounting light into bracket.
- High-strength, corrosion-free, UV-resistant gray polymer.
- Available to fit both flat and curved surfaces. 176-13 has 4.6" radius curve for proper fit on curved surfaces.
- Easily amounts with two screws (not included).

Order No.	Description	Pack	Std Carton
176-10	for flat surfaces	poly pack	6
176-13	for curved surfaces	poly pack	6
B176-10	for flat surfaces	mfg. pack	100
B176-13	for curved surfaces	mfg. pack	100

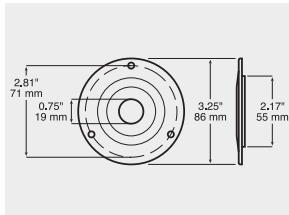

176-11

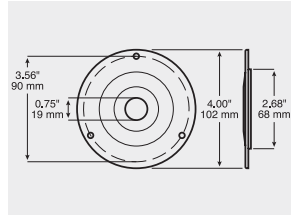

176-12

## 176-11/176-12

### 2" & 2½" Retrofit Adapter Flanges

- Retrofits 171, 176, 177, 181 and 271 series single-diode clearance / marker lights into existing 2" & 2.5" mounting holes.
- Raised lip on reverse fits into existing hole for easy, accurate centering.
- Requires three rivets (recommended) or screws for mounting.
- Made of corrosion-resistant, high-strength polymer.
- Available in gray or black.
- 176-19 has a smaller 2.625" bolt hole pattern and completely flat back to replace competitive lights.

Order No.	Description	Pack	Std Carton
176-11	2", gray	poly pack	6
176-12	2.5", gray	poly pack	6
B176-15	2", black	mfg. pack	50
B176-17	2.5", black	mfg. pack	50
B176-19	2", black, 2.625" bolt pattern	mfg. pack	50

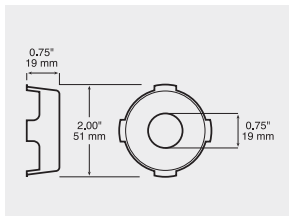

176-14

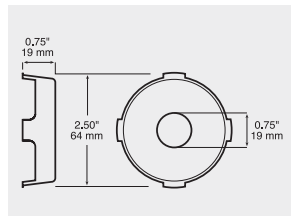

176-16

## 176-14/176-16

### 2" & 2½" Retrofit Adapter



- Retrofits 171, 176, 177, 181 and 271 series single-diode clearance / marker lights into existing 2" & 2.5" mounting holes.
- 176-14 use with 2" 146-18 grommet.
- 176-16 use with 2½" 143-18 and 144-18 grommets.
- Corrosion resistant black ABS construction.

Order No.	Description	Pack	Std Carton
176-14	2" retrofit adapter	poly pack	6
176-16	2 ½" retrofit adapter	poly pack	6

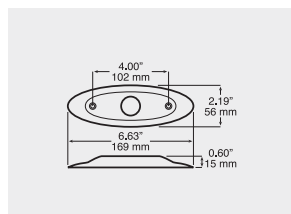

## 178

### Decorative Chrome Bezel

- Enhances appearance of 178 LED lamp.
- Attractive chrome finish.
- Corrosion-resistant ABS construction.

Order No.	Description	Pack	Std Carton
178-10	chrome	poly pack	12
B178-10	chrome	mfg. pack	100





290-09  
290C light not included



290-091  
290C light not included

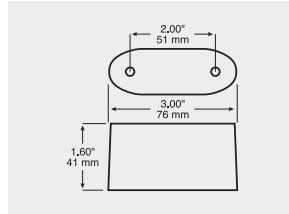
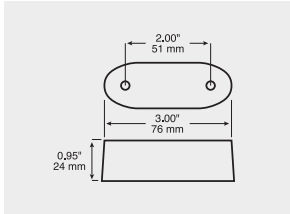

## 290

### License Light Spacer Bracket



- Surface-mounts on 2" centers.
- 290 series license light is DOT-compliant when used properly with spacer.
- 290-09 0.95" spacer for use with 290C light as center top mount license light.
- 290-091 1.60" spacer for use with 290C as a single side mount license light.

Order No.	Description	Pack	Std Carton
290-09	0.95" spacer bracket	poly pack	12
290-091	1.60" spacer bracket	poly pack	12

STT

TURN

MARKER

B-U/UTIL

SPEC

EMERG

ECE

MOUNT

ELECT

REFLECT

ACCY

MERCH

TECH



B186-10

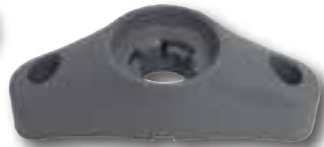
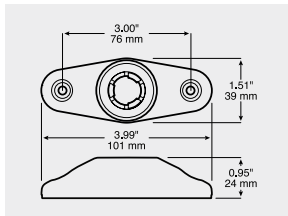

B186-13

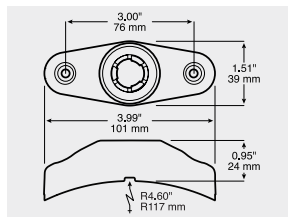

## 186

### Surface-Mount Brackets



- Allows 186/286 Dot Light XL™ to surface-mount on curved or flat surfaces.
- Made of corrosion-resistant, high-strength polycarbonate.
- Easily mounts with two screws (not included).
- Attractive gray finish.

Order No.	Description	Pack	Std Carton
B186-10	flat surfaces	mfg. pack	100
B186-13	curved surfaces	mfg. pack	100

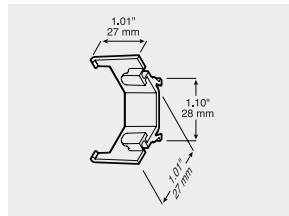

## 359-10

### Mounting Clip



- Allows 359 series LED lights to attach to corner mounting rails without screws.
- Constructed of corrosion-resistant, high-strength polycarbonate.

Order No.	Description	Pack	Std Carton
B359-10	black	mfg. pack	100

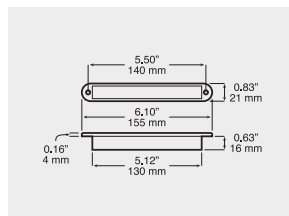
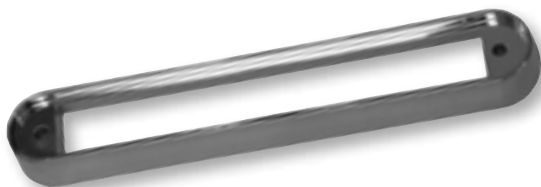

## 388

### Surface Mount Bracket

- Allows 388-series LED lights to be surface mounted.
- Attractive chrome finish.
- Corrosion-resistant ABS construction.

Order No.	Description	Pack	Std Carton
388-09X	chrome	poly pack	12
B388-09X	chrome	mfg. pack	50

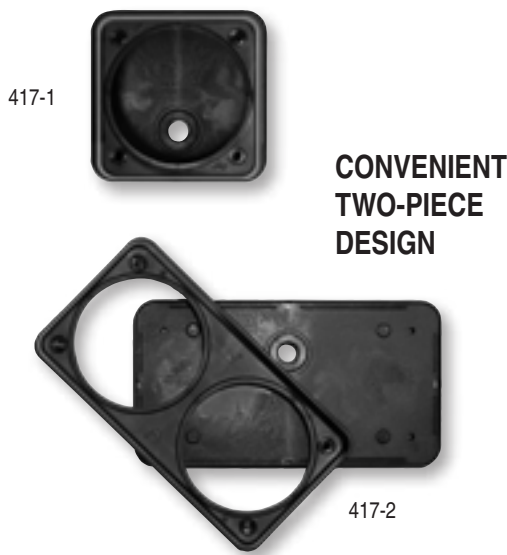

## 417

### Surface Mount Brackets

- Available in 1, 2, and 3 light versions.
- Compatible with all current Peterson grommet-mount 4" round LED lights except 816, 826, and 827 series lights.
- Lights snap in easily, with no grommet required.
- Brackets feature separate backing plate with 1" (25 mm) cable exit hole and integral mounting studs, plus attachment screws.

Order No.	Description	Pack	Std Carton
P417-1	single light	poly pack	6
417-1	single light	mfg. pack	40
417-2	double light	mfg. pack	20
417-3	triple light	mfg. pack	10

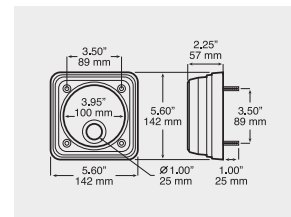

417-1

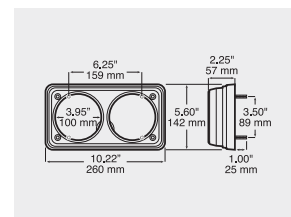

417-2

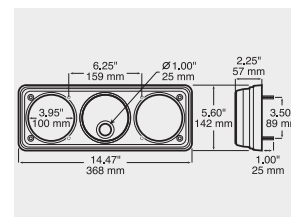

417-3

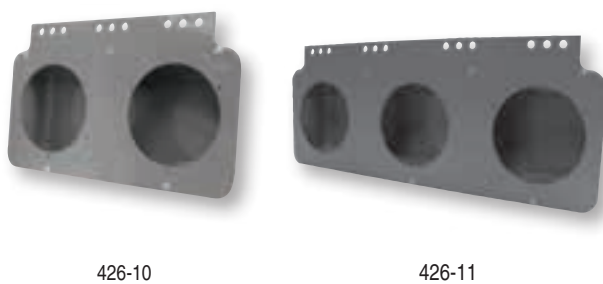

## 426

### 2 or 3 Light Metal Module

- For use with PM 4" round lights, as well as similar competitors' lights.
- Designed as replacement for many OE trailer light modules.
- Fits all grommet-mounted and most flange-mounted 4" dia. lamps.
- 426-10 has openings for two lights, 426-11 has three.

Order No.	Description	Pack	Std Carton
426-10	2 light	box	6
426-11	3 light	box	6

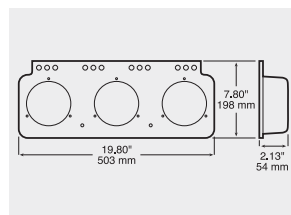
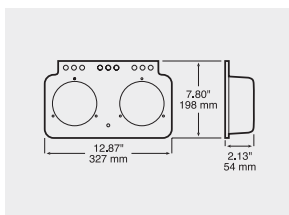

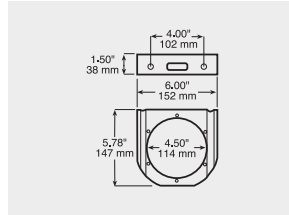

426

## Steel Right-Angle Mounting Bracket



- Black, powder-coated steel.
- For use with PM 4" round lights, as well as similar competitors' lights.
- May be bolted or welded in place.
- Fits all grommet-mounted and most flange-mounted 4" dia. lamps.
- Use 426-18 to complete grommet installation.

Order No.	Description	Pack	Std Carton
426-09	black steel	box	6

STT

TURN

MARKER

B-U/UTIL

SPEC

EMERG

ECE

MOUNT

ELECT

REFLECT

ACCY

MERCH

TECH

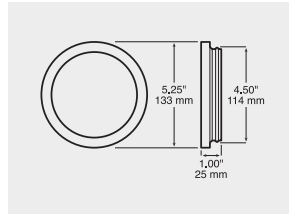

426

## 4" Grommet



- Black PVC grommet flush mounts 4" diameter round lamps in 4 1/2" hole.
- For use with 4" round stop/turn/tail and accessory lights.
- Provides additional shock absorption to extend lamp life.

Order No.	Description	Pack	Std Carton
426-18	black	poly pack	12
B426-18	black	mfg. pack	100

418

## Decorative Chrome Bezel

- Bright chrome decorative bezel snaps on without tools.
- Covers black flange and mounting screws.
- 418-10 fits 418R-4 round LED light.

Order No.	Description	Pack	Std Carton
B418-10	chrome round	mfg. pack	50

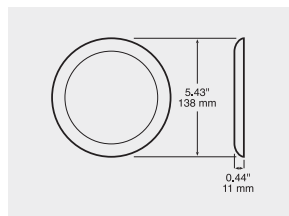

424

## Snap-In Bracket



- Snap-in bracket for use with PM 4" round lights, as well as similar competitors' lights.
- Corrosion-free, high-impact plastic construction.

Order No.	Description	Pack	Std Carton
424-09	black	poly pack	24

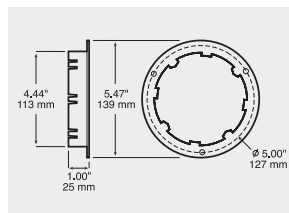

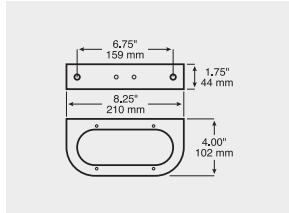

## 421 Mounting Bracket



- Black, powder-coated steel.
- Fits standard 6.5" oval grommet lights, with pre-drilled mounting holes for mounting flanged lights. (Not compatible with 823RTL-7.)
- May be bolted or welded in place.
- May be used horizontally or vertically.
- Grommet-mount lights require 421-18 grommet to for installation.

Order No.	Description	Pack	Std Carton
421-09	black oval	box	6

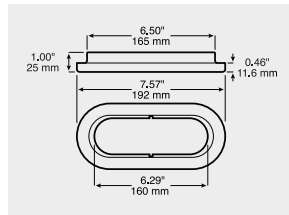

## 421 Oval Grommet



- Black PVC grommet flush mounts oval style lamps.
- For use with PM standard 6.5" oval grommet-mount oval lights, as well as similar competitors' lights.
- Provides additional shock absorption to extend lamp life.

Order No.	Description	Pack	Std Carton
421-18	black oval	poly pack	12
B421-18	black oval	mfg. pack	100

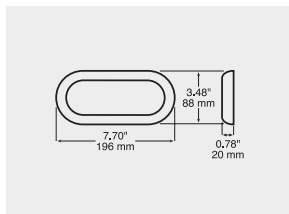

## 423 Decorative Chrome Bezel

- Bright chrome decorative bezel snaps on without tools.
- Covers black flange and mounting screws.
- Fits surface-mount oval LED lights 423A-4, 423R-4, 423W-4, 1223A-4, 1223R-4, and 1223A-R-4.

Order No.	Description	Pack	Std Carton
423-11	chrome oval	poly pack	12
B423-11	chrome oval	mfg. pack	50



Shown with light installed, sold separately

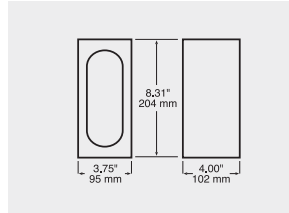

## 794 LED

### Weld-On Steel Mounting Box

- Heavy-gauge steel weld box provides incredibly durable mount for standard, grommet-mount oval lights.
- Ideal for construction, refuse and other rough duty vehicles.

Order No.	Description	Pack	Std Carton
794-09	weld box only	box	1

STT

TURN

MARKER

B-U/UTIL

SPEC

EMERG

ECE

MOUNT

ELECT

REFLECT

ACCY

MERCH

TECH



817-10

817-09

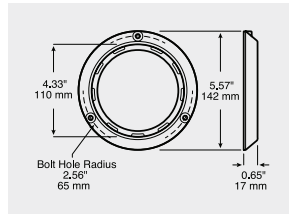

## 817

### Surface Mount Bracket for 4" Round Lights



- Allows grommet-style 4" round lights to be surface mounted.
- Constructed of UV and corrosion resistant plastic
- Available in black or chrome finish.
- Compatible with LumenX "-7" and "-9" series 4" round lights.

Order No.	Description	Pack	Std Carton
817-09	black	poly pack	12
817-10	chrome	poly pack	12
B817-09	black	mfg. pack	50
B817-10	chrome	mfg. pack	50



820-09



820-10 (light sold separately)

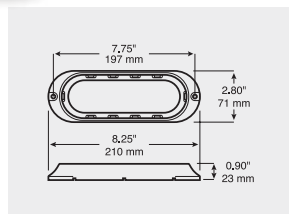

## 820

### Surface Mount Bracket for Oval Lights



- Allows grommet-style oval lights to be surface mounted.
- Constructed of UV and corrosion resistant plastic
- Available in black or chrome finish.
- Compatible with LumenX "-7" and "-10" series oval lights.

Order No.	Description	Pack	Std Carton
820-09	black	poly pack	12
820-10	chrome	poly pack	12
B820-09	black	mfg. pack	50
B820-10	chrome	mfg. pack	50

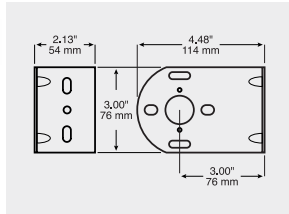

510

## Universal Mounting Bracket



- Black powder-coat finish.
- 3" wide x 4 1/2" tall.
- For use with most PM stud mount tail lights.

Order No.	Description	Pack	Std Carton
510-9	black steel	mfg. pack	24

## 520-09 Nightwatcher® LX Clamp-On Mounting Bracket

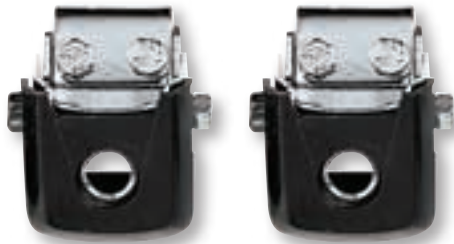

- Universal clamp-on bumper brackets for all fog and driving lights.
- Rugged, chrome plated steel.
- Self-service Viz Pack packaging.

Order No.	Description	Pack	Std Carton
V520-09	mounting bracket	Viz Pack	6

450

## Rectangular Rubber Grommet

- Black PVC grommet flush mounts incandescent 3"x 5" rectangular lamps.
- For use with 450 series stop, turn, tail, turn signal and backup lights, as well as similar competitors' lights.
- Provides additional shock absorption to extend lamp life.

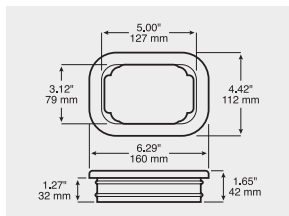

Order No.	Description	Pack	Std Carton
450-18	black	poly pack	12
B450-18	black	mfg. pack	50

850

## Mounting Grommet

- Black rubber grommet fits 850 series lights.
- UV-resistant PVC stays flexible and prevents cracking for extended service life.
- Requires mounting opening configured to match diagram shown.

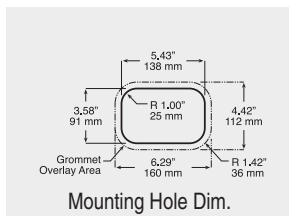
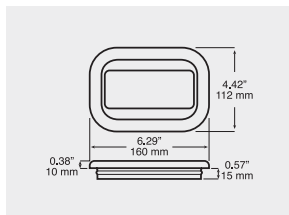

Order No.	Description	Pack	Std Carton
850-18	black	poly pack	12
B850-18	rubber grommet	mfg. pack	50

850-09  
(850A turn signal  
available separately)



850-1



850-092H



850-092V



850-093H



850-093V

Shown with light installed, sold separately

**CONVENIENT  
TWO-PIECE  
DESIGN**

## 850

### Stud Mount Light Modules

- High-strength, corrosion-free, UV-resistant, black glass-filled nylon.
- All 850 series rectangular LED lights snap in easily.
- Not compatible with incandescent lights.
- No mounting grommets required.
- 850-09 has two 0.25" (6 mm) screw mounting holes, others have separate backing plate with 1" (25 mm) cable exit hole and integral mounting studs, plus 1.20" (30 mm) long, black stainless, self-cutting #10 pozi-drive screws.

Order No.	Description	Pack	Std Carton
850-1	single light w/ back plate	poly pack	50
850-09	2-screw mnt. w/o back plate	mfg. pack	10
850-092H	double light, horizontal	mfg. pack	30
850-092V	double light, vertical	mfg. pack	30
850-093H	triple light, horizontal	mfg. pack	20
850-093V	triple light, vertical	mfg. pack	20

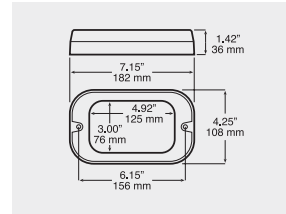

850-09

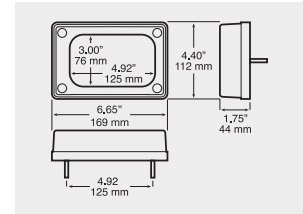

850-1

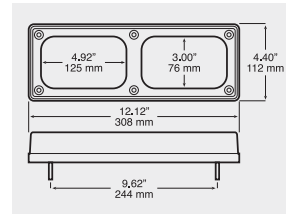

850-092H

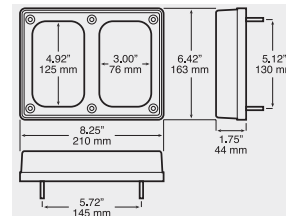

850-092V

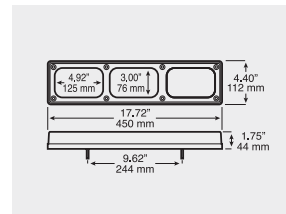

850-093H

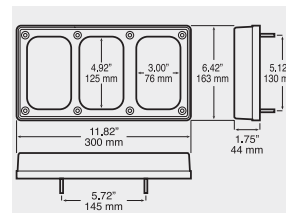

850-093V

STT

TURN

MARKER

B-U/UTIL

SPEC

EMERG

ECE

MOUNT

ELECT

REFLECT

ACCY

MERCH

TECH

## 740 LED

### Mounting Bracket for Magnetic Safety Beacon

- Heavy-duty galvanized metal.
- Provides sturdy mounting point for 740-series magnetic beacons.

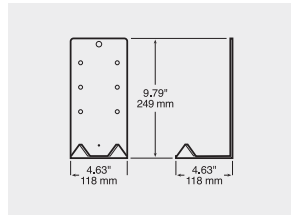

Order No.	Description	Pack	Std Carton
740-09	bracket	box	1

## 1200

### Mounting Bracket

- For mounting 1200 ECE-compliant LED lamps at a right angle to the mounting surface.
- Attractive satin black finish.
- ABS construction.

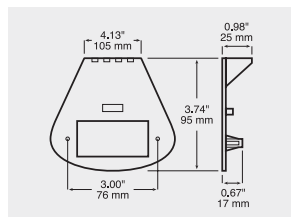

Order No.	Description	Pack	Std Carton
1200-09H	horizontal	mfg. pack	50

## 1200

### Decorative Chrome Bezel

- Enhances appearance of 1200 ECE-compliant LED lamp.
- Attractive chrome finish.
- ABS construction.

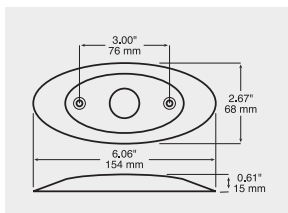

Order No.	Description	Pack	Std Carton
1200-09X	chrome	poly pack	12
B1200-09X	chrome	mfg. pack	50



STT

TURN

MARKER

B-U/UTIL

SPEC

EMERG

ECE

MOUNT

ELECT

REFLECT

ACCY

MERCH

TECH

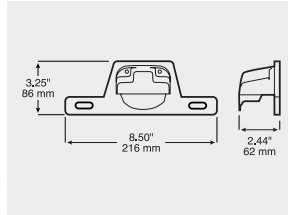

150

License/Utility Bracket

- Licence plate bracket and 150-141 license light bracket riveted together.
- Requires 150C or 153C light and 142-49 plug to complete installation.

Order No.	Description	Pack	Std Carton
B150-141B	black plastic	mfg. pack	24

428

Universal License Bracket



- For use with most PM stud-mounted tail lights.
- Zinc-plated steel

Order No.	Description	Pack	Std Carton
V428-09	steel	Viz Pack	12
428-09	steel	box	24
B428-09	steel	mfg. pack	50

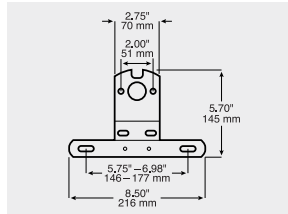
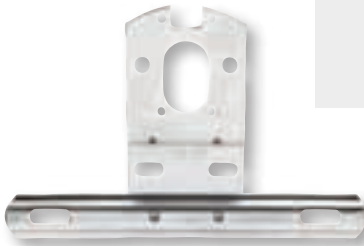

440

Universal License Bracket



- For use with most PM stud-mounted tail lights.
- Corrosion-free black plastic which flexes on impact.

Order No.	Description	Pack	Std Carton
V440-09	black	Viz Pack	12
440-09	black	box	24
B440-09	black	mfg. pack	100

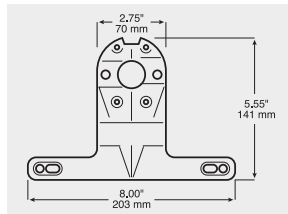

25900

Universal RV License Plate Bracket



- Universal license plate bracket.
- Direct replacement for OE bracket on many popular RVs.
- Rugged steel construction.

Order No.	Description	Pack	Std Carton
V25900-09	steel	Viz Pack	10

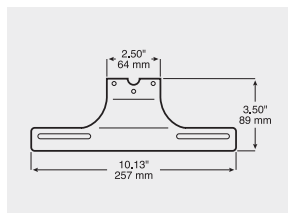

## FOR GROMMET STYLE LIGHTS

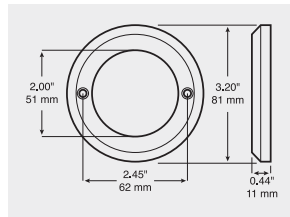

### 7005 2" Round Decorative Bezels



- Chrome-plated plastic enhances appearance.
- Attaches to rubber grommet with two tapered screws.
- Fits grommet-mounted 2" round vehicle lights.
- Includes stainless steel mounting screws.
- Attractive visual packaging.

Order No.	Description	Pack	Std Carton
V7005	2" round bezel	Viz Pack	24

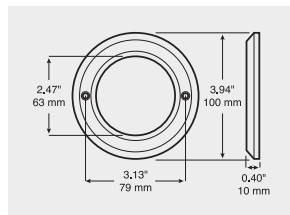

### 7007 2 1/2" Round Decorative Bezel



- Chrome-plated plastic enhances appearance.
- Attaches to rubber grommet with two tapered screws.
- Fits grommet-mounted 2 1/2" round vehicle lights.
- Includes stainless steel mounting screws.
- Attractive visual packaging.

Order No.	Description	Pack	Std Carton
V7007	2 1/2" round bezel	Viz Pack	24

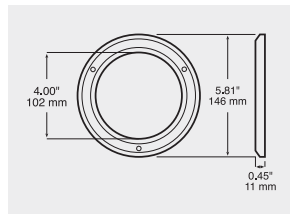

### 7009 4" Round Decorative Bezel



- Chrome-plated plastic enhances appearance.
- Attaches to rubber grommet with three tapered screws.
- Fits grommet-mounted 4" round vehicle lights.
- Includes stainless steel mounting screws.
- Attractive visual packaging.

Order No.	Description	Pack	Std Carton
V7009	4" round bezel	Viz Pack	24

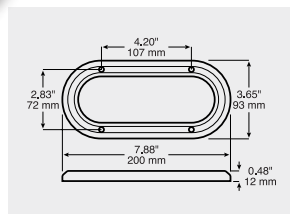

### 7011 Oval Decorative Bezels



- Chrome-plated plastic enhances appearance.
- Attaches to rubber grommet with four tapered screws.
- Fits grommet-mounted 6 1/2" x 2 1/4" oval vehicle lights.
- Includes stainless steel mounting screws.
- Attractive visual packaging.

Order No.	Description	Pack	Std Carton
V7011	oval bezel	Viz Pack	24

**FOR FLANGE STYLE LIGHTS**

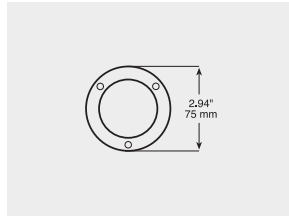

**7005S  
Theft Deterrent Rings**

- Fits 2" round flange-mounted lights.
- Designed to work with flange for added theft protection.
- Attractive stainless-steel finish resists corrosion.
- Embossed with PM logo.
- Not compatible with "S" suffix surface-mount lights.

Order No.	Description	Pack	Std Carton
7005S	2" round	poly pack	12
B7005S	2" round	mfg. pack	25

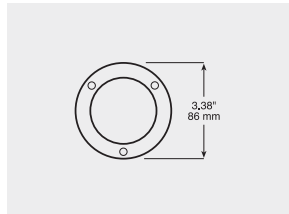

**7007S  
Theft Deterrent Rings**

- Fits 2.5" round flange-mounted lights.
- Designed to work with flange for added theft protection.
- Attractive stainless-steel finish resists corrosion.
- Embossed with PM logo.
- B7007S fits 162F and 163F lights.
- 7012 fits 192F and 193F lights.
- 7013 fits 192S, 193S and 233S surface-mount lights.

Order No.	Description	Pack	Std Carton
7007S	3.5" dia./2.5" opening/3.04" bolt cir.	poly pack	12
B7007S	3.5" dia./2.5" opening/3.04" bolt cir.	mfg. pack	25
7012	3.75" dia./2.5" opening/3.20" bolt cir.	mfg. pack	25
7013	3.75" dia./2.75" opening/3.20" bolt cir.	mfg. pack	25

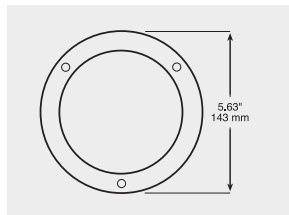

**7009S  
Theft Deterrent Rings**



- Fits 4" round flange-mounted lights.
- Designed for added theft protection of flange-mount lights.
- Attractive stainless-steel finish resists corrosion.
- Embossed with PM logo.

Order No.	Description	Pack	Std Carton
V7009S	4" round	Viz Pack	25
7009S	4" round	poly pack	12
B7009S	4" round	mfg. pack	25

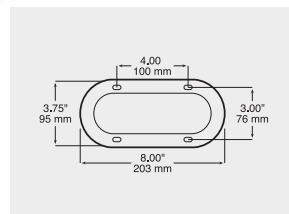

**7011S  
Theft Deterrent Rings**

- Fits 6 1/2" x 2 1/4" oval flange-mounted lights.
- Designed for added theft protection of flange-mount lights.
- Attractive stainless-steel finish resists corrosion.
- Embossed with PM logo.

Order No.	Description	Pack	Std Carton
7011S	oval	poly pack	12
B7011S	oval	mfg. pack	25

STT  
TURN  
MARKER  
B-U/UTIL  
SPEC  
EMERG  
ECE  
MOUNT  
ELECT  
REFLECT  
ACCY  
MERCH  
TECH

45

## Certificate Holder and Pouch



- Keeps permit or license clean and dry in any weather.
- Dust-proof and weatherproof vinyl pouch with zipper seal.
- Heavy gauge aluminum frame.
- Frame measures 7 1/4" x 4 7/8".
- Pouch measures 7" x 4 5/8".
- Mounts on 6 3/8" centers.

Order No.	Description	Pack	Std Carton
45	holder & pouch	poly pack	24
B45	holder & pouch	mfg. pack	100
45-171	replacement pouch	poly pack	24

46

## Round Certificate Holder

- Keeps permit or license clean and dry in any weather.
- Cam-on translucent cover has gasketed seal.
- High-impact plastic.
- Tension spring holds documents in place with cover removed.

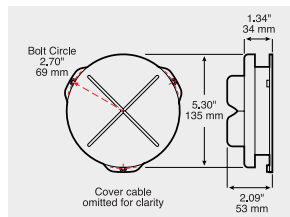

Order No.	Description	Pack	Std Carton
46	certificate holder	poly pack	12
B46	certificate holder	mfg. pack	30

2954

## ABS Label



- Conforms to NHTSA requirements for labeling ABS malfunction lamps.
- Heavy-duty material and industrial adhesive backing for durability.
- Flexible design adheres to curved surfaces.
- 4.00" x 1.25" with 1" letters.

Order No.	Description	Pack	Std Carton
2954	ABS label	mfg. pack	100



**554/557**  
**10-Lamp Electro-Mechanical Flashers**



- 10-lamp, 12-volt flasher.
- Available for medium-duty (2-prong) and heavy-duty (3-prong) applications.
- 21.0 amp rating.
- 60-120 FPM flash rate at 11 to 15 volts.
- 1 3/8" tall, fits easily into most applications.
- Meets FMVSS 108 and SAE J590 & J945 specifications.

Order No.	Description	Pack	Std Carton
V554	2-prong	Viz Pack	3
554	2-prong	poly pack	6
557	3-prong	poly pack	6



**570/571**  
**12-Lamp Electro-Mechanical Flashers**



- 12-lamp, 12-volt flasher.
- Available for medium-duty (2-prong) and heavy-duty (3-prong) applications.
- 25.2-amp rating.
- 70-120 FPM flash rate.
- 1 1/2" tall, fits into small areas with limited access.
- Meets FMVSS 108 and SAE J590 & J945 specifications.

Order No.	Description	Pack	Std Carton
V570	2-prong	Viz Pack	6
570	2-prong	poly pack	12
571	3-prong	poly pack	12
B570	2-prong	mfg. pack	100



**572**  
**Electronic Flasher for LED Lights**

- 12-volt flasher.
- 2.5 amp rating.
- 76-96 FPM flash rate at 9-16 volt.
- Meets FMVSS 108 and SAE J590 & J945 specifications.

Order No.	Description	Pack	Std Carton
572	2-prong	box	6

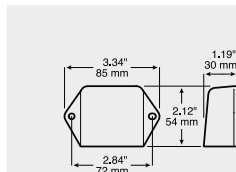

**5000**  
**Multi-Volt Solid-State LED Flasher**



- Resolves flash rate issues caused by reduced resistance LED lights.
- Surface-mount, fully encapsulated, solid-state flasher.
- For use with LED and/or incandescent lamps.
- Operates at .01 to 17 amps between 9–32 volts.
- Retrofit standard 2- and 3- prong flashers using included hardware.
- Complete kit includes 1 jumper wire, 1 tie-down, 2 mounting screws, 3 blade terminals, 1 #10 ring terminal, and instruction sheet.
- Meets FMVSS 108 and SAE J590, J945 & J2068 specifications.

Order No.	Description	Pack	Std Carton
5000	flasher kit	poly pack	12

STT  
TURN  
MARKER  
B-U/UTIL  
SPEC  
EMERG  
ECE  
MOUNT  
ELECT  
REFLECT  
ACCY  
MERCH  
TECH



573/574

16-Lamp Electronic Flashers



- 16-lamp, 12-volt flasher.
- Available for medium-duty (2-prong) and heavy-duty (3-prong) applications.
- 35 amp rating.
- 60-120 FPM flash rate.
- Electronic chip improves switching operations and extends life.
- Internal components are designed for high temperature operation.
- 1 7/8" tall.
- Meets FMVSS 108 and SAE J590 & J945 specifications.

Order No.	Description	Pack	Std Carton
V573	2-prong	Viz Pack	3
573	2-prong	poly pack	12
574	3-prong	poly pack	12



576/577

20-Lamp Electronic Flashers



- 20-lamp, 12-volt flasher.
- Available for medium-duty (2-prong) and heavy-duty (3-prong) applications.
- 45-amp max rating.
- 60-120 FPM flash rate.
- Electronic chip improves switching operations and extends life.
- 1 7/8" tall.
- Meets FMVSS 108 and SAE J590 & J945 specifications.

Order No.	Description	Pack	Std Carton
V576	2-prong	Viz Pack	3
576	2-prong	poly pack	12
577	3-prong	poly pack	12



579

Alternating, 10-Lamp Electronic Flasher

- 12-volt flasher.
- Alternating, three-prong flasher.
- 10 lamp capacity per side.
- Will flash four headlights or equivalent in emergency or warning lights.
- 25-amp max rating.
- 60-120 FPM flash rate.
- Meets FMVSS 108 and SAE J590 & J945 specifications.

Order No.	Description	Pack	Std Carton
579	3-prong	poly pack	12



**UL APPROVED**

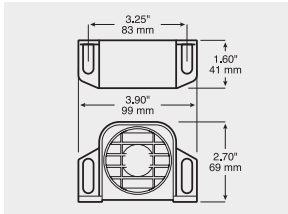

## 780 97 dB Back-Up Alarm



- 97-decibel volume.
- For all trucks and rubber-tire vehicles.
- 12-24 volt operating range.
- Less than 0.6 amp draw.
- -40° to +185° F temperature range.
- ABS housing and epoxy-sealed internal components for vibration and moisture protection.
- Unit may be grounded through mounting screw.
- Meets SAE J994 Type C requirements.
- Meets IP65 ingress protection standard.
- Self-service visual packaging.

Order No.	Description	Pack	Std Carton
V780	97 dB	Viz Pack	6
780	97 dB	box	6



**UL APPROVED**

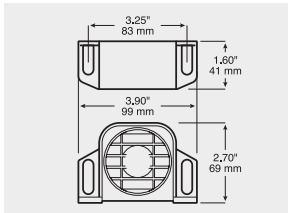

## 781 102 dB Back-Up Alarm



- 102-decibel volume.
- For medium-duty applications in higher noise areas.
- 12-24 volt operating range.
- Less than 0.6 amp draw.
- -40° to +185° F temperature range.
- ABS housing and epoxy-sealed internal components for vibration and moisture protection.
- Unit may be grounded through mounting screw.
- Meets SAE J994 Type F requirements.
- Meets IP65 ingress protection standard.
- Self-service visual packaging.

Order No.	Description	Pack	Std Carton
V781	102 dB	Viz Pack	6
781	102 dB	box	6

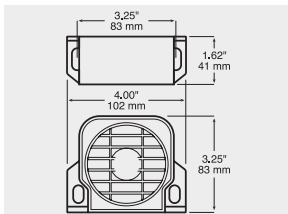

## 782 107 dB Back-Up Alarm



- Features the same form factor as Peterson's existing 780 & 781 back-up alarms with louder alarm volume.
- 12-24 volt operating range.
- Can be mounted to horizontal or vertical surfaces.
- Less than 0.8 amp draw.
- ABS housing and epoxy-sealed internal components for vibration and moisture protection.
- Unit may be grounded through mounting screw.
- Meets SAE J994 Type B specifications.
- Available with stripped leads or .180 bullet terminals.

Order No.	Description	Pack	Std Carton
782	107 dB, stripped leads	box	6
782-BT2	107 dB, .180 bullets	box	6

STT  
TURN  
MARKER  
B-U/UTIL  
SPEC  
EMERG  
ECE  
MOUNT  
ELECT  
REFLECT  
ACCY  
MERCH  
TECH

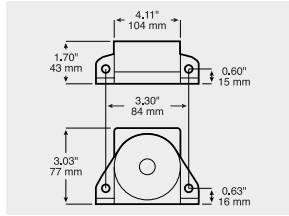

783

87 dB Auxiliary Back-Up Alarm



- 87-decibel volume suitable for auxiliary warning applications.
- 12-24 volt operating range.
- Glass filled nylon housing and epoxy-sealed internal components for vibration and moisture protection.
- Unit may be grounded through mounting screw.
- Sealed lens and housing meets IP65 ingress protection level.
- Meets IP65 ingress protection standard.
- Self-service visual packaging.

Order No.	Description	Pack	Std Carton
V783	87 dB	Viz Pack	6

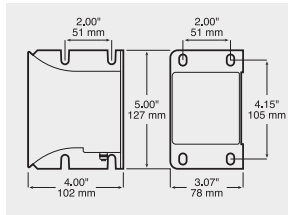

784/785

Back-Up Alarm



- Model 784 features 112 dB volume & meets SAE J994 Type A specifications.
- Model 785 features 97–112 dB variable volume that automatically senses and adjusts to ambient noise levels.
- 12–24 volt operating range.
- Less than 0.8 amp draw.
- Can be mounted to horizontal or vertical surfaces.

Order No.	Description	Pack	Std Carton
784	112 dB	box	1
785	97-112 dB variable	box	1

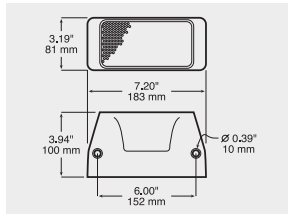

784-C

Back-Up Alarm



- 112 dB volume
- 12-24V voltage range
- Less than 0.8 amp average current draw
- Reverse polarity and spike protection
- Rugged full-coverage housing
- Epoxy-encapsulated circuit board

Order No.	Description	Pack	Std Carton
784-C	112 dB	box	10

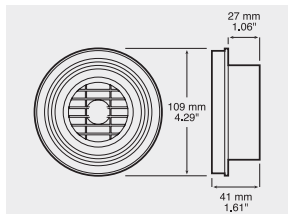

786

Back-Up Alarm



- Fits circular opening used for standard 4-inch round, grommet-mount lights.
- Available in 97 dB and 102 dB versions.
- 786-97 has 12–48 volt operating range, meets SAE J994 Type C specs.
- 786-102 has 12–24 volt operating range, meets SAE J994 Type F specs.
- Comes complete with standard 426-18 mounting grommet.

Order No.	Description	Pack	Std Carton
786-97	97 dB	box	1
786-102	102 dB	box	1





**135-951**  
**Replacement Wire**



- Replacement lead wire for 106, 130, 135, and 138 series incandescent marker lights.

Order No.	Description	Pack	Std Carton
135-951	lead wire, black	poly pack	100

STT

TURN

MARKER

B-U/UTIL

SPEC

EMERG

ECE

MOUNT

ELECT

REFLECT

ACCY

MERCH

TECH

**142-49/50/51**  
**Marker Lamp Plugs**



- 2-wire molded plug for clearance and marker lights.
- Fits 140, 142, 143, 145, 146, 150, 189 & 190 series, plus competitive lights.
- Includes a #10 ring terminal on ground wire; hot wire is stripped.
- See page 178 for optional plug retaining clip.

Order No.	Description	Pack	Std Carton
142-49	6" leads	poly pack	12
B142-49	6" leads	mfg. pack	100
B142-50	19" leads	mfg. pack	100
B142-51	12" leads	mfg. pack	100
B162-093	retaining clip	mfg. pack	100

**146-49**  
**Marker Lamp Harness**



- Features two molded plugs with 2-wire termination.
- Included with M246K clearance light kit.
- Also fits 142, 143, 145, 146, and 150 series clearance and marker lights.
- Includes #10 ring terminal on ground wire; hot wire is blunt cut.
- May be used as harness for individual corner or ID lights.

Order No.	Description	Pack	Std Carton
B146-49	15" leads	mfg. pack	100

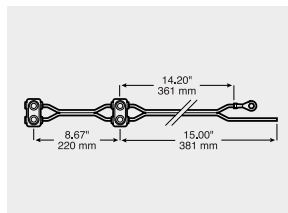

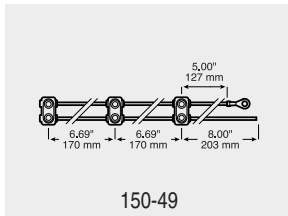

150-49

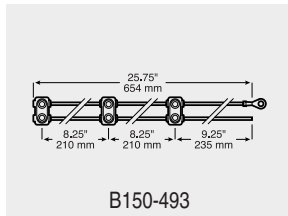

B150-493

## 150-49 ID Bar Lamp Harness



- Fits lights requiring PL10 style plug.
- Choice of 6.70" or 8.25" between receptacles.
- 150-49 replaces wire harness on 150-3 series identification light bar.
- Fits all competitive models.
- 5" ground wire w/ ring terminal and 8" hot wire.
- Includes #10 ring terminal on ground wire; hot wire is stripped.
- May be used as harness for individual corner or ID lights.

Order No.	Description	Pack	Std Carton
150-49	6.7" centers	poly pack	10
B150-493	8.25" centers	mfg. pack	50

## 150-491 Lead Wire



- Single lead wire with male .156 termination and stripped end.
- Designed for use with 150 series lights and to provide additional connections on 154 series lights.

Order No.	Description	Pack	Std Carton
B150-491	.156 molded male, 18"	mfg. pack	100

## 152-49 Lead Wire



- Single lead wire with female .156 termination and stripped end.
- Designed for use with 152 series light.

Order No.	Description	Pack	Std Carton
152-49	.156 molded female, 17"	poly pack	10
B152-49	.156 molded female, 17"	mfg. pack	100

## 153-49/492 Marker Lamp Plugs



153-49



153-492

- 2-wire molded female plug for use with 152, 153, 154 and 161 series clearance and marker lights.
- 153-49 has ground wire with #10 ring terminal and stripped hot wire.
- B153-492 adapter plug mates male pin lamps to male pin harnesses.

Order No.	Description	Pack	Std Carton
153-49	6" leads	poly pack	12
B153-49	6" leads	mfg. pack	100
B153-492	8" adapter	mfg. pack	100



**160-49/491/492**  
**Marker Lamp Plugs**



- Right-angle, two-wire plug for use with 155, 157 and 160 series LED clearance and marker lights.
- 8" leads
- 160-49 includes #10 ring terminal and stripped end.
- 160-491 includes #10 ring terminal and .180 bullet terminal.
- 160-492 includes two .180 bullet terminals.

Order No.	Description	Pack	Std Carton
160-49	ring term & stripped lead	poly pack	12
160-491	ring term & .180 bullet	poly pack	12
160-492	two .180 bullets	poly pack	12
B160-49	ring term & stripped lead	mfg. pack	100
B160-491	ring term & .180 bullet	mfg. pack	100
B160-492	two .180 bullets	mfg. pack	100

**160-493**  
**ID Bar Harness**



- Identification light bar replacement wire harness for 160-3 series.
- Includes two .180 bullet terminals for easy installation.

Order No.	Description	Pack	Std Carton
160-493	6.25" centers, .180 bullets	poly pack	12

**162-49/493**  
**LED Marker Lamp Plugs**



B162-093 retaining clip

- Right-angle TRIPLE SEAL, two-wire plug for use with 162, 163, 164, 165, and 166 series LED clearance/marker lights.
- 162-49 includes 8" stripped hot wire; ground wire provided with #10 ring terminal and heat shrink tubing for additional corrosion protection.
- 162-493 includes two .180 bullet terminals.
- See page 178 for optional plug retaining clip.

Order No.	Description	Pack	Std Carton
V162-49	stripped/ring	Viz Pack	6
162-49	stripped/ring	poly pack	12
162-493	.180 bullets	poly pack	12
B162-49	stripped/ring	mfg. pack	100
B162-493	.180 bullets	mfg. pack	100
B162-093	retaining clip	mfg. pack	100

STT

TURN

MARKER

B-U/UTIL

SPEC

EMERG

ECE

MOUNT

ELECT

REFLECT

ACCY

MERCH

TECH



## 176-496

### Lead Wire Adapter Kit



- Adapts hardwired leads to 0.180" bullet connectors.
- 7.5" overall length
- Special ridged design creates highly effective moisture barrier when mated to Maxi-Seal® advanced harness components.
- Kit contains 6 white wires with female receptacles, 6 black wires with female receptacles, and 12 heat-shrink butt splice connectors.

Order No.	Description	Pack	Std Carton
176-496	<b>KIT</b> adapter kit	poly pack	6
B176-491	white female leads	mfg. pack	100
B176-492	black female leads	mfg. pack	100
B176-493	white male leads	mfg. pack	100
B176-494	black male leads	mfg. pack	100

## 192-492/493

### LED 2-Wire Plug

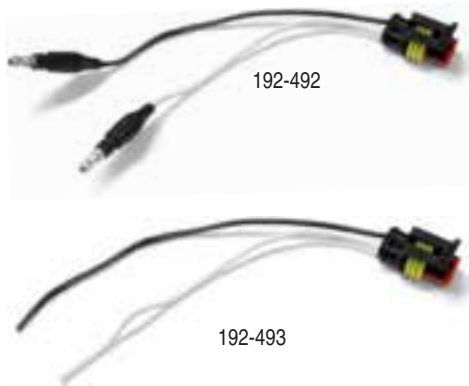

- 2-wire hard-shell, weatherproof plug.
- For use with 173, 175, 189, 190, 192, 193, 194, 195, 197, 199, 905 and 906 series LED lights that are equipped with AMP-compatible receptacles.
- 192-492 terminated with two .180 bullet terminals.
- 192-493 has blunt-cut wires.
- Grease is not recommended on AMP-style connections.

Order No.	Description	Pack	Std Carton
192-492	hardshell, .180 bullets	poly pack	12
B192-492	hardshell, .180 bullets	mfg. pack	50
B192-493	hardshell, blunt-cut wires	mfg. pack	50

## 193-492

### Molded LED 2-Wire Plug



- 2-wire weatherproof plug with molded plug housing.
- For use with 173, 175, 189, 190, 192, 193, 194, 195, 197, 199, 905 and 906 series LED lights that are equipped with AMP-compatible receptacles.
- Terminated with two .180 bullet terminals, can be removed for hardwiring into vehicle harness.
- Grease is not recommended on AMP-style connections.

Order No.	Description	Pack	Std Carton
193-492	molded, .180 bullets	poly pack	12
B193-492	molded, .180 bullets	mfg. pack	100

## 344-49 Turn Signal Plug



- 3-wire hard shell, weather proof design.
- Replacement plug for 344 turn signal lights.
- Ground wire and two hot wires are blunt cut.



Order No.	Description	Pack	Std Carton
344-49	9" leads	poly pack	12

## 411-07 Pigtail



- Single wire with brass contact, nylon washer, and plug with stainless steel spring.
- Non-indexing type for all G-6, S-8, and S-11 single contact bulbs.



Order No.	Description	Pack	Std Carton
411-07	10" lead	poly pack	25

## 413-07 Pigtail



- Two wires with brass contacts, nylon washer, and plug with stainless steel spring.
- Indexing type for all S-8 double contact bulbs.



Order No.	Description	Pack	Std Carton
413-07	10" leads	poly pack	25

STT
TURN
MARKER
B-U/UTIL
SPEC
EMERG
ECE
MOUNT
ELECT
REFLECT
ACCY
MERCH
TECH

## 417-48/481/482 LED 2-Wire Plugs



- 2-wire hard-shell, weatherproof plug.
- For use with 817, 818, 820, 823, 1217, 1218, 1220, 1223 series LED lights.
- 417-48 includes stripped hot wire; ground wire provided w/ #10 ring terminal and heat-shrink tubing for additional corrosion protection.
- 417-481 adapter plug fits 421-49 and 431-49 plugs.
- 417-482 includes two .180 bullet terminals.
- Grease is not recommended on AMP-style connections.

Order No.	Description	Pack	Std Carton
417-48	stripped lead/ring terminal	poly pack	6
417-481	adapter plug	poly pack	6
417-482	.180 bullets	poly pack	6
B417-48	stripped lead/ring terminal	mfg. pack	100
B417-481	adapter plug	mfg. pack	100

## 817-48/481/482 Molded LED 2-Wire Plugs



- 2-wire weatherproof plug with molded plug housing.
- For use with 817, 818, 820, 823, 1217, 1218, 1220, 1223 series LED lights.
- 817-48 includes stripped hot wire; ground wire provided w/ #10 ring terminal and heat-shrink tubing for additional corrosion protection.
- 817-481 adapter plug fits 421-49 and 431-49 plugs.
- 817-482 includes two .180 bullet terminals.
- Grease is not recommended on AMP-style connections.

Order No.	Description	Pack	Std Carton
817-48	stripped lead/ring terminal	poly pack	12
B817-48	stripped lead/ring terminal	mfg. pack	100
817-481	adapter plug	mfg. pack	100
B817-482	.180 bullets	mfg. pack	100

## 417-49/491/492 LED 3-Wire Plugs



- 3-wire hard-shell, weatherproof plug.
- For use with 233, 817, 818, 820, 823, 1217, 1218, 1220, 1223 series LED lights.
- 417-49 includes stripped hot wires; ground wire provided w/ #10 ring terminal and heat shrink tubing for additional corrosion protection.
- 417-491 adapter plug fits 421-491 and 431-491 plugs.
- 417-492 includes three .180 bullet terminals.
- Grease is not recommended on AMP-style connections.

Order No.	Description	Pack	Std Carton
417-49	stripped lead/ring terminal	poly pack	6
417-491	adapter plug	poly pack	6
B417-49	stripped lead/ring terminal	mfg. pack	100
B417-491	adapter plug	mfg. pack	100
B417-492	.180 bullets	mfg. pack	100



**817-49/491/492**  
**Molded LED 3-Wire Plugs**



- 3-wire weatherproof plug with molded plug housing.
- For use with 233, 817, 818, 820, 823, 1217, 1218, 1220, 1223 series LED lights.
- 817-49 includes stripped hot wires; ground wire provided w/ #10 ring terminal and heat-shrink tubing for additional corrosion protection.
- 817-491 adapter plug fits 421-491 and 431-491 plugs.
- 817-492 includes three .180 bullet terminals.
- 817-497 has one AMP-compatible plug and one Packard-style plug.
- Grease is not recommended on AMP-style connections.

Order No.	Description	Pack	Std Carton
817-49	stripped lead/ring terminal	poly pack	12
817-497	AMP to Packard shroud adapter	poly pack	6
B817-49	stripped lead/ring terminal	mfg. pack	100
B817-491	adapter plug	mfg. pack	100
B817-492	.180 bullets	mfg. pack	100



**817-49L**  
**AMP-Compatible Lead Wire**



- 3-wire, AMP-compatible harness with jacketed flat cable.
- Available in 12" and 98.5" lengths.
- For use with 817, 818, 820, 823, 1217, 1218, 1220, 1223 series LED lights.
- 817-49S and 817-49L have stripped hot wires and #10 ring terminal on ground wire.

Order No.	Description	Pack	Std Carton
B817-49S	12" overall, stripped lead/ring terminal	mfg. pack	50
B817-49L	98.5" overall, stripped lead/ring term.	mfg. pack	50



**880-49/491/496**  
**AMP-Compatible Plugs**



- B880-49 & B880-491 adapter plugs connect back-up light function on 880/881/882/883 series lights to standard PL2/PL3 or AMP style harness connections.
- B880-49 can be used to connect sync wire on 860SA, 861SA, 866SA and 867SA series multi-function LED strobes.
- Grease is not recommended on AMP-style connections.

Order No.	Description	Pack	Std Carton
880-49	stripped wire	poly pack	6
B880-49	stripped wire	mfg. pack	100
B880-491	adapter plug	mfg. pack	100
B880-496	hardshell receptacle	mfg. pack	100

STT  
TURN  
MARKER  
B-U/UTIL  
SPEC  
EMERG  
ECE  
MOUNT  
ELECT  
REFLECT  
ACCY  
MERCH  
TECH

866-486

Packard-to-AMP 1-Wire Adapter



- Adapter plug connects single wire back-up light or strobe sync function to Packard-style harness connections.

Order No.	Description	Pack	Std Carton
866-486	AMP to Packard shroud adapter	poly pack	6
B866-486	AMP to Packard shroud adapter	mfg. pack	100

417-491Y

LED Y-Adapter Plug



- Converts one PL3-style stop/turn/tail plug into two LED hard-shell, weather-proof stop/turn/tail plugs.
- For use with non-hardwired lights.
- Grease is not recommended on AMP-style connections.

Order No.	Description	Pack	Std Carton
417-491Y	12" adapter plug	poly pack	6

417-491MP

LED Adapter Plug



- Converts single male-pin lamp connection into LED hard-shell, weatherproof stop/turn/tail plug.
- For use with non-hardwired lights.
- Grease is not recommended on AMP-style connections.

Order No.	Description	Pack	Std Carton
417-491MP	12" adapter plug	poly pack	6





**417-493**  
**Adapter Plug**



- Adapts PL3 lamp to wiring terminated with LED-style plug.
- Grease is not recommended on AMP-style connections.

Order No.	Description	Pack	Std Carton
V417-493	adapter plug	Viz Pack	6
417-493	adapter plug	poly pack	10



**417-496**  
**Extension Harness**



- Terminated with one male and one female hard-shell, weatherproof stop/turn/tail plug.
- Provides an extra 10 inches of length between LED light and vehicle harness.
- Grease is not recommended on AMP-style connections.

Order No.	Description	Pack	Std Carton
417-496	extension harness	poly pack	6
B417-496	extension harness	mfg. pack	100

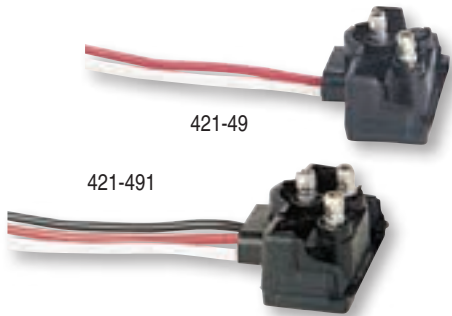

**421-49/491**  
**Right-Angle PL3 Plugs**



- 2-wire (-49) and 3-wire (-491) right angle plugs for single or double contact sealed stop/turn or backup lamps.
- Includes #10 ring terminal on ground wire; hot wire is stripped.

Order No.	Description	Pack	Std Carton
421-49	2-wire, rt. angle, 10.5"	poly pack	12
421-491	3-wire, rt. angle, 10.5"	poly pack	12
B421-49	2-wire, rt. angle, 10.5"	mfg. pack	100
B421-491	3-wire, rt. angle, 10.5"	mfg. pack	100

STT  
TURN  
MARKER  
B-U/UTIL  
SPEC  
EMERG  
ECE  
MOUNT  
ELECT  
REFLECT  
ACCY  
MERCH  
TECH

## 421-491RS Resistor Harness



- For use when upgrading existing vehicle turn signals from incandescent to LED.
- In-line 50 watt, 10 ohm resistor.
- 10.63" (270 mm) overall length.
- Provides adequate resistance for proper flasher module operation.
- Terminated with one male and one female PL3 plug.

Order No.	Description	Pack	Std Carton
421-491RS	resistor harness	poly pack	12

## 421-491Y PL3 "Y" Adapter Plug



- 3-wire molded plug converts one PL3 stop/turn/tail plug into two.

Order No.	Description	Pack	Std Carton
421-491Y	Y-adapter plug, 12"	poly pack	6

## Harness Extensions

- Connects to "Y" adapter to provide auxiliary strobe power.
- Choice of two lengths for simple, flexible, efficient installation.
- Hardshell connector on each end (one female plug, one shrouded male plug).

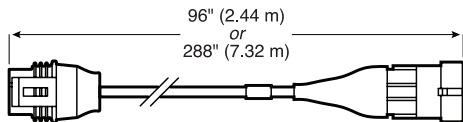

Order No.	Description	Pack	Std Carton
817-49288	extension harness, AMP style, 288"	poly pack	6
817-4996	extension harness, AMP style, 96"	poly pack	6

## "Y" Adapter Harness

- Installs between brake light and existing trailer harness to provide brake circuit power to auxiliary strobe.
- Three AMP-compatible hardshell connectors (two female plugs, one shrouded male plug).
- 12.5" length.

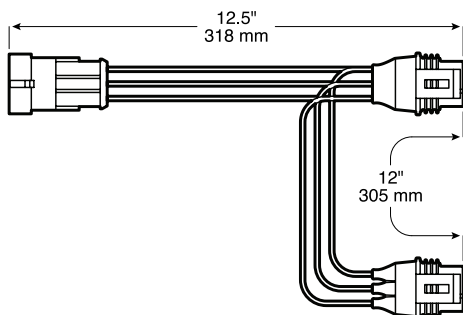

Order No.	Description	Pack	Std Carton
817-49Y	STT Y-plug, AMP style, 12.5"	poly pack	6

**431-49/491**  
**Straight PL3 Wire Plugs**



- 2-wire (-49) and 3-wire (-491) molded plugs for single or double contact sealed stop/turn/tail lamps.
- Includes #10 ring terminal on ground wire; hot wire is stripped.

Order No.	Description	Pack	Std Carton
V431-49	2-wire, straight, 10.5"	Viz Pack	6
V431-491	3-wire, straight, 10.5"	Viz Pack	6
431-49	2-wire, straight, 10.5"	poly pack	12
431-491	3-wire, straight, 10.5"	poly pack	12
B431-49	2-wire, straight, 10.5"	mfg. pack	100
B431-491	3-wire, straight, 10.5"	mfg. pack	100

**431-492**  
**Extension Harness**



- 3-wire harness terminated with one male and one female PL3 stop/turn/tail plug.
- Provides over 12 additional inches of length between light and vehicle harness.
- 12.75" (324 mm) overall length.

Order No.	Description	Pack	Std Carton
B431-492	extension harness	mfg. pack	100

**701-491**  
**LED Headlight Anti-Flicker Harness**



- Anti-flicker harness plug for 701C series LED headlights.
- Used on specific CANBUS equipped vehicles, including Jeeps 2007 and newer.
- 11" (280 mm) length.
- Not compatible with daytime running lights (DRL) in Canada.

Order No.	Description	Pack	Std Carton
701-491	anti-flicker harness	poly pack	50

**778-48**  
**Replacement Cable**



- Replacement for standard cable included with 778A Sequencing LED Light Bar
- 15 foot length

Order No.	Description	Pack	Std Carton
778-48	replacement harness	poly pack	1

STT  
TURN  
MARKER  
B-U/UTIL  
SPEC  
EMERG  
ECE  
MOUNT  
ELECT  
REFLECT  
ACCY  
MERCH  
TECH

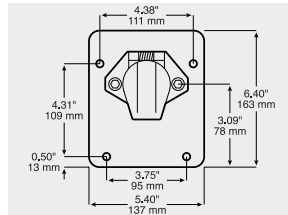

## 374 Defender® Trailer Nose Box



- Surface-mount nose box has reinforced nylon housing and aluminum faceplate.
- Fits industry-standard mounting bolt pattern.
- #10 studs provide capacity for multiple terminals.
- Stainless steel terminal springs grip pins.
- Conforms to SAE J560 specifications.

Order No.	Description	Pack	Std Carton
P374	J560 Nose box, solid pins	poly pack	8



373 solid pin version



411 split pin version

## 373/411 Defender® J560 7-Way Insert



- Deep socket receptacle is 3/8" deeper than previous model for more secure, reliable hook-up.
- Receptacle available in solid pin and split pin versions.
- Reinforced nylon housing.
- Conforms to SAE J560 specifications.
- Spring-loaded hinge retainer pin to keep out contaminants when not in use.
- Direct wire ground.
- Includes neoprene mounting gasket.

Order No.	Description	Pack	Std Carton
P373	J560 7-way insert, solid pins	poly pack	25
P411	J560 7-way insert, split pins	poly pack	25

## Spec Your Trailer With the DEFENDER Harness and LED Lighting System.

Stay lit and stay on the road with the only harness and LED lighting system guaranteed\* for **10 years** against corrosion. With heavy-duty terminals, integrated moisture barrier, advanced silicone seals, modular design, and a patented hard-shell J560 connector — **DEFENDER** stops corrosion *before* it starts. When you need to deliver, drive with **DEFENDER**.



\*See dealer for details.



Scan for  
**DEFENDER®**  
Demo Video

**STOP**  
WIRING CORROSION  
BEFORE IT STARTS.



Exclusive advances in modular harness technology make DEFENDER® virtually impervious to moisture and corrosion.



**2730**  
**Accessory Plug/Socket**



- Polycarbonate plastic accessory plug and socket.
- Nickel-plated, phosphor-bronze metals for corrosion resistance.
- Socket fits all types of 12-volt accessories.
- Includes O-ring gasket and weather flap for protection.
- Plug features easy, no-solder, screw trap connection.

Order No.	Description	Pack	Std Carton
V2730	plug and socket set	Viz Pack	6
V2730S	socket	Viz Pack	6
V2730P	plug	Viz Pack	6
M2730S	socket	mfg. pack	48
M2730P	plug	mfg. pack	48



**5404**  
**Round 4-Way Connector**

- Round, four-way trunk and trailer connector.
- Bright chrome-plated finish.
- Spring loaded cover on trunk connector.
- Brass contacts.

Order No.	Description	Pack	Std Carton
5404	complete kit	poly pack	10

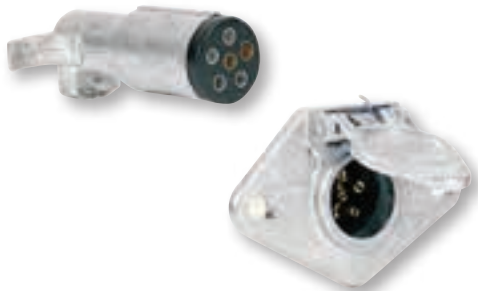

**5406**  
**Round 6-Way Connector**

- Round, 6-way male and female connectors.
- Molded interiors.
- Stainless steel spring on receptacle cover protects against corrosion and helps ensure dust and water-resistant seal.

Order No.	Description	Pack	Std Carton
5406P	plug	poly pack	10
5406S	socket	poly pack	10



**5407**  
**Round 7-Way Connector**

- 7-way male and female connectors for heavy duty use.
- Diecast zinc construction.
- Accepts wide range of wire gauges.
- Built-in socket slant provides easy alignment and maximum contact.

Order No.	Description	Pack	Std Carton
5407P	plug	poly pack	10
5407S	socket	poly pack	10

STT  
TURN  
MARKER  
B-U/UTIL  
SPEC  
EMERG  
ECE  
MOUNT  
ELECT  
REFLECT  
ACCY  
MERCH  
TECH



## 5410 Tail Light Converter



- Use in place of our 5400B trunk connector when towing vehicle utilizes turn signal separate from stop/tail lamp.
- Converts 5-wire system down to 4-wire system.
- Heavy-duty, 10-amp transistors prevent premature failure.
- Includes all electrical connections and installations instructions.

Order No.	Description	Pack	Std Carton
V5410	complete kit	Viz Pack	6
B5410	complete kit	mfg. pack	24



## 5411 4-Way Flat Tester



- Tester plugs into connector of tow vehicle and illuminates when the electrical connections are correct.
- Tests to SAE standards on flat 4-way functions for tail light, stop/turn lights, and ground.
- Self-service Viz Pack packaging.

Order No.	Description	Pack	Std Carton
V5411	tester	Viz Pack	6



## 5413 6 to 4-Way Harness Adapter



- Converts 6-Way Round connector to 4-Way Flat connector.
- Easily adapts tow vehicle connector to trailer connector.
- Full length plug shell ensures positive latching.
- Non-corrosive nylon shell.
- 7A max current through ground. Sum of all current through other terminals should not exceed 7 amps.
- Self-service Viz Pack packaging.

Order No.	Description	Pack	Std Carton
V5413	3" length	Viz Pack	6



## 5414 7 to 4-Way Harness Adapter



- Converts 7-Way Round blade connector to 4-Way Flat pin connector.
- Easily adapts tow vehicle connector to trailer connector.
- Full-length plug shell ensures positive latching.
- Features non-corrosive nylon shell.
- 7A max current through ground. Sum of all current through other terminals should not exceed 7 amps.
- Self-service Viz Pack packaging.

Order No.	Description	Pack	Std Carton
V5414	3 1/2" length	Viz Pack	6
5414	3 1/2" length	poly pack	12



**5415**  
**7 to 5-Way Harness Adapter**



- Converts 7-Way Round blade connector to 5-Way Flat pin connector.
- Easily adapts tow vehicle connector to trailer connector.
- Simply plug adapter into tow vehicle connector and plug in trailer connector.
- Full length plug shell ensures positive latching.
- Non-corrosive nylon shell.
- 7A max current through ground. Sum of all current through other terminals should not exceed 7 amps.
- Self-service Viz Pack packaging.

Order No.	Description	Pack	Std Carton
V5415	4" length	Viz Pack	6
5415	4" length	poly pack	12



**5416**  
**7 to 4-Way Harness Adapter**



- Converts 7-Way Round pin connector to 4-Way Flat pin connector
- Easily adapts tow vehicle connector to trailer connector.
- Full length plug shell ensures positive latching.
- Non-corrosive nylon shell.
- 7A max current through ground. Sum of all current through other terminals should not exceed 7 amps.
- Self-service Viz Pack packaging.

Order No.	Description	Pack	Std Carton
V5416	4" length	Viz Pack	6



**5417**  
**7 to 6-Way Harness Adapter**



- Converts 7-Way Round blade connector to 6-Way Round pin connector.
- Easily adapts tow vehicle connector to trailer connector.
- Full length plug shell ensures positive latching.
- Non-corrosive nylon shell.
- 7A max current through ground. Sum of all current through other terminals should not exceed 7 amps.
- Self-service Viz Pack packaging.

Order No.	Description	Pack	Std Carton
V5417	4" length	Viz Pack	6

STT  
TURN  
MARKER  
B-U/UTIL  
SPEC  
EMERG  
ECE  
MOUNT  
ELECT  
REFLECT  
ACCY  
MERCH  
TECH

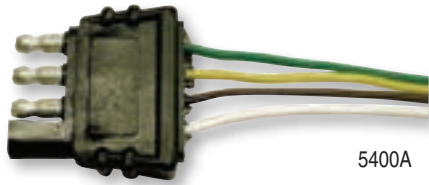

5400A

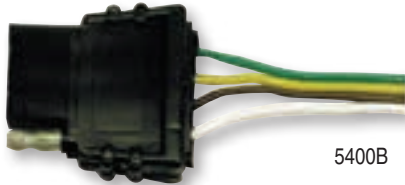

5400B

## 5400A Trailer Connector



- Flat four-way trailer connector.
- 5400A has 12" lead wires.
- 5400B has three 48" lead wires and 12" ground wire.
- Color coded wire meets SAE J1128 specifications.
- Plug meets SAE J1239 specifications.

Order No.	Description	Pack	Std Carton
V5400A	4-way trailer connector	Viz Pack	6
V5400B	4-way trunk connector	Viz Pack	6
B5400A	4-way trailer connector	mfg. pack	100
B5400B	4-way truck connector	mfg. pack	100

## 5401 Trailer/Trunk Extension Harnesses



- 30" harness extension.
- Available in both 4-way and 5-way flat configurations.
- Each configuration has trailer connector on one end and trunk connector on other.
- Perfect for those times when an extension is needed between the tow vehicle and trailer.

Order No.	Description	Pack	Std Carton
V5401	4-way	Viz Pack	6

## 5425 Split Trailer Harness Kit

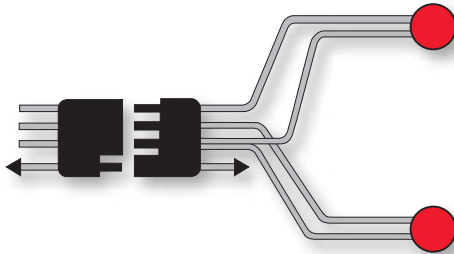

- 25', split, four conductor harness.
- Designed to split at trailer tongue and run down each side of frame.
- Flat four-way plug meets SAE J1239 specifications, includes trunk connector.
- Color-coded wire meets SAE J1128 specifications.

Order No.	Description	Pack	Std Carton
V5425Y	complete kit	Viz Pack	6
B5425Y	complete kit	mfg. pack	25

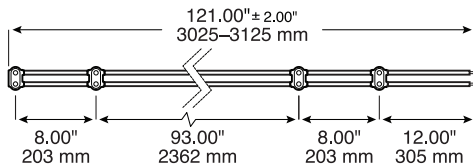

Not to scale. Some details enlarged for clarity.

2412

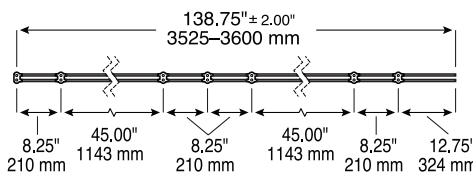

Not to scale. Some details enlarged for clarity.

2712

## 2412/2712 Clearance/Marker/ID Wire Harness



- Front clearance and side marker harness features 16-gauge wire with four molded plugs.
- Rear clearance, rear side marker, and identification light harness features 18-gauge wire with seven molded plugs.

Order No.	Description	Pack	Std Carton
B2412	front, 10'	mfg. pack	50
B2712	rear, 11'	mfg. pack	50





## 2578 Breakaway Switch

- Required by law in some states.
- Ensures braking on towed vehicle during an accidental separation of trailer and towing vehicle.
- Emergency use only, not for braking when parked or stored.

Order No.	Description	Pack	Std Carton
2578	switch w/ lanyard	mfg. pack	120
2578-1	lanyard only	mfg. pack	250

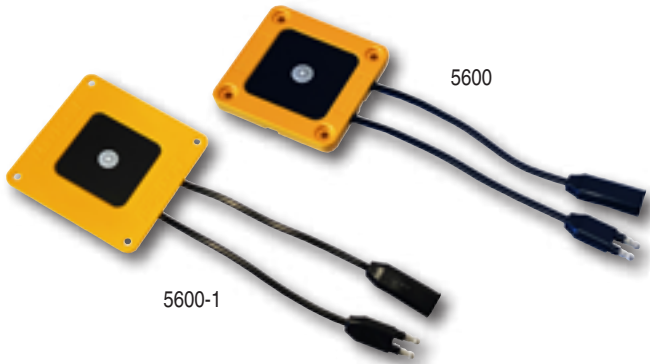

## 5600 Timer Box Switch

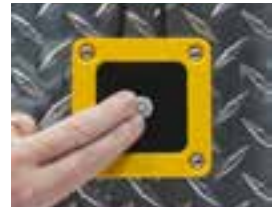

- 10 amp maximum load.
- IP68 ingress rating. Suitable for installation inside or outside of vehicle.
- Pre-programmed for 30, 60, or 90 minutes of ON time per button push.
- 5600 and 5603 versions can be programmed for up to 2 hours of constant ON time by pressing the button up to 4 times (30 min added per push).
- Additional time can be added at any time, up to maximum.
- Lights flash per button push to indicate that command is received.
- Pushing and holding button turns off lights at any time.
- "2 minute warning" slowly dims and raises light level prior to shut-off.
- 9–32 volt operating range.
- Must be used in conjunction with 10 amp fuse for circuit protection.
- 5603 has 90" leads w/ individual bullet plugs rather than unified connector.

Two Bullet Connector Styles



5600, 5601, 5602

5603

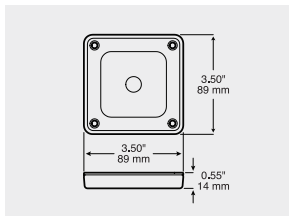

Surface Mount  
5600, 5602, 5603

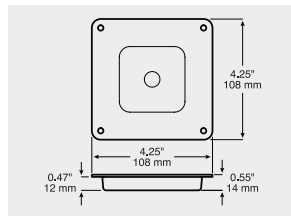

Recessed Mount  
5600-1, 5601

Order No.	Description	Leads	Interval	Max Time	Pack	Std Carton
P5600	surface	8"	30 min	120 min	poly pack	12
P5600-1	recessed	8"	30 min	120 min	poly pack	12
5600	surface	8"	30 min	120 min	mfg. pack	50
5600-1	recessed	8"	30 min	120 min	mfg. pack	50
5601	recessed, orange	8"	60 min	60 min	mfg. pack	50
5602	surface	8"	90 min	90 min	mfg. pack	50
5603	surface, 2 plugs	90"	30 min	120 min	mfg. pack	2

## 520-40 Nightwatcher® LX 40 Amp Relay



- Universal relay for safety and protection.
- 40-amp heavy duty capacity.
- Guards against overloads and arcing.
- 12-volt only.
- Self-service Viz Pack packaging.

Order No.	Description	Pack	Std Carton
V520-40	relay	Viz Pack	12



STT  
TURN  
MARKER  
B-U/UTIL  
SPEC  
EMERG  
ECE  
MOUNT  
ELECT  
REFLECT  
ACCY  
MERCH  
TECH



### 520-41 Nightwatcher® LX Illuminated Rocker Switch



- Universal rocker switch for all quartz halogen lamps and other lighting applications.
- Illuminated.
- 15 amp capacity.
- Self-service Viz Pack packaging.

Order No.	Description	Pack	Std Carton
V520-41	rocker switch	Viz Pack	12



### 19-41 Back-Up Mechanical Switch



- For vehicles not originally equipped with back-up lights.
- Heavy-duty, water and dust tight switch with 360 degree movement.
- Includes mounting bracket and cable grip connector.
- 12-36V DC, 5 amps max.
- Meets SAE J249 specifications.

Order No.	Description	Pack	Std Carton
19-41	heavy-duty	box	12



### 500 Turn Signal Switch



- 7-wire unit for vehicles with combination stop and turn signal lamps requiring brake light circuit.
- Includes built-in pilot lights to indicate left and right turn.
- Heavy diecast flat black enamel housing w/ chrome-plated lever.
- Hazard warning switch with hazard pilot light.
- Supplied with universal steering column clamp and in-line fuse.
- Flasher not included.

Order No.	Description	Pack	Std Carton
V500	7-wire	Viz Pack	6
500	7-wire	box	6



### 5501 Switch Panel



- Durable black plastic mounts easily for convenient switch mounting.
- 1/2" diameter hole accommodates most standard toggle switches.
- Also accepts PMV5525PT indicator light.

Order No.	Description	Pack	Std Carton
PMV5501PT	black	Viz Pack	1

# SWITCHES

# ELECTRICAL ACCESSORIES



Order No.	Description	Std Carton
PMV5503PT	ignition switch – 4 stud .75" dia. hole 30A	1



Order No.	Description	Std Carton
PMV5504PT	flush mount horn button black plastic with nickel plated housing 5A 12V	1



Order No.	Description	Std Carton
PMV5509PT	HD momentary on push-button w/boot 60A 12V	1



Order No.	Description	Std Carton
PMV5512PT	push-button momentary on switch 5/8" mount hole 15A 12V 25A 6V	1



Order No.	Description	Std Carton
PMV5522PT	heavy duty push/pull on-off switch 3/8" mount hole with chrome plated metal knob and 2 screws 75A 6-28V	1



Order No.	Description	Std Carton
PMV5579PT	euro switch push/pull on-off 5/16 mount hole with screws 12V 16A	1



Order No.	Description	Std Carton
PMV5510PT	on-off metal bat handle toggle SPST switch with 2 screws 15A 12V	1



Order No.	Description	Std Carton
PMV5511PT	metal ball handle SPST toggle 3A/250V 5A/125V	1

STT
TURN
MARKER
B-U/UTIL
SPEC
EMERG
ECE
MOUNT
ELECT
REFLECT
ACCY
MERCH
TECH



Order No.	Description	Std Carton
PMV5513PT	weather resistant on-off toggle SPST switch with toggle boot 20A 12V	1



Order No.	Description	Std Carton
PMV5536PT	illuminated red on-off SPST toggle switch 1/2" mount hole with 1/4" blades 16A 12V	1



Order No.	Description	Std Carton
PMV5537PT	illuminated blue on-off SPST toggle switch 1/2" mount hole with 1/4" blades 16A 12V	1



Order No.	Description	Std Carton
PMV5540PT	black on-off SPST toggle switch 1/2" mount hole with 1/4" blades 16A 12V	1



Order No.	Description	Std Carton
PMV5543PT	heavy duty on-off-on SPDT toggle switch die cast 3 copper screw tabs and 3 brass screws 1/2" mount hole with indicator plate 50A 6-12V	1



Order No.	Description	Std Carton
PMV5544PT	heavy duty on-off-on momentary SPDT toggle switch die cast 3 copper screw tabs and 3 brass screws 1/2" mount hole with indicator plate 50A 6-12V	1



Order No.	Description	Std Carton
PMV5545PT	heavy duty SPST die cast 2 copper screw tabs and 2 brass screws 1/2" mount hole with indicator plate 50A 6-12V	1



Order No.	Description	Std Carton
PMV5546PT	on-off-on metal bat handle SPDT toggle switch 1/2" mount hole with indicator plate 15A 12V	1

# SWITCHES

# ELECTRICAL ACCESSORIES



Order No.	Description	Std Carton
PMV5560PT	illuminated red led on-off SPST toggle switch 1/2" mount hole with 1/4" blades 12V 10A	1



Order No.	Description	Std Carton
PMV5561PT	illuminated blue led on-off SPST toggle switch 1/2" mount hole with 1/4" blades 12V 10A	1



Order No.	Description	Std Carton
PMV5562PT	illuminated amber led on-off SPST toggle switch 1/2" mount hole with 1/4" blades 12V 10A	1



Order No.	Description	Std Carton
PMV5563PT	illuminated green led on-off SPST toggle switch 1/2" mount hole with 1/4" blades 12V 10A	1



Order No.	Description	Std Carton
PMV5571PT	On-Off SPST Toggle Switch with Red LED Indicator Light in Brushed Aluminum Bat Handle 12 Volt 15 Amp	1



Order No.	Description	Std Carton
PMV5572PT	heavy duty on-off SPST toggle switch die cast red handle 2 copper screw tabs and 2 brass screws 1/2" mount hole with indicator plate 50A 6-12V	1



Order No.	Description	Std Carton
PMV5576PT	on-off metal bat handle toggle SPST switch with indicator plate 3A 240 vac 6A 120 vac	1



Order No.	Description	Std Carton
PMV5577PT	on-off metal bat handle toggle SPST switch with indicator plate 20A 12V	1

STT
TURN
MARKER
B-U/UTIL
SPEC
EMERG
ECE
MOUNT
ELECT
REFLECT
ACCY
MERCH
TECH

# ELECTRICAL ACCESSORIES



Order No.	Description	Std Carton
PMV5570PT	weather resistant boot with threaded mounting nut for toggle switches fits 3/8" to 5/8" by 1/2" toggle	1

# SWITCHES & INDICATOR LIGHTS



Order No.	Description	Std Carton
PMV5530PT	illuminated red on-off SPST rocker switch with 1/4" blades 16A 12V	1



Order No.	Description	Std Carton
PMV5580PT	illuminated red on-off oblong rocker switch 1/2" mount hole and 1/4" blades 25A 12V	1



Order No.	Description	Std Carton
PMV5583PT	illuminated green on-off oblong rocker switch 1/2" mount hole and 1/4" blades 12V 25A	1



Order No.	Description	Std Carton
PMV5584PT	illuminated red led on-off oblong rocker switch 1/2" mount hole and 1/4" blades 12V 25A	1



Order No.	Description	Std Carton
PMV5587PT	illuminated green led on-off oblong rocker switch 1/2" mount hole and 1/4" blades 12V 25A	1



Order No.	Description	Std Carton
PMV5525PT	indicator light - illuminated red 1/2" mount hole with 1/4" blades 16A 12V	1



Order No.	Description	Pack	Std Carton
PMV5564PT	indicator light - illum. red, 7/16" mtg hole, 1/4" blades 12V 15A	Viz Pack	1
PM5564PT	indicator light - illum. red, 7/16" mtg hole, 1/4" blades 12V 15A	poly pack	50



**0002**  
**Solderless Terminal Assortment**



- 175 pieces.
- Comes complete in sturdy, closeable plastic container.

Order No.	Description	Pack	Std Carton
PMV0002-T	terminal kit	Viz Pack	1



**1585**  
**Alligator Clip Assortment**



- 6 pieces.
- Assorted sizes and styles.

Order No.	Description	Pack	Std Carton
PMV1585KT	alligator clip assortment	Viz Pack	1



**6110**  
**Grommet Assortment**



- 15 pieces.
- Assorted sizes and styles.

Order No.	Description	Pack	Std Carton
PMV6110PT	grommet assortment	Viz Pack	1



**7029**  
**Carburetor Cap Assortment**



- Durable, flexible vinyl construction
- 40 pieces.
- Assorted sizes and styles.

Order No.	Description	Pack	Std Carton
PMV7029PT	carburetor cap assortment	Viz Pack	1



**510/511**  
**Frame Clips**



- Securely and safely attaches harness to trailer frame.
- Available in medium- or heavy-duty strength.

Order No.	Description	Pack	Std Carton
B510-72	medium-duty	mfg. pack	100
B511-72	heavy-duty	mfg. pack	100

510-72

511-72

STT  
TURN  
MARKER  
B-U/UTIL  
SPEC  
EMERG  
ECE  
MOUNT  
ELECT  
REFLECT  
ACCY  
MERCH  
TECH

# ELECTRICAL ACCESSORIES

# WIRING & TERMINALS



Order No.	Description	Std Carton
PMV0905PT	15 AMP fuse holder 16 AWG Qty 1	1
PMV0906PT	30 AMP fuse holder 12 AWG Qty 1	1



Order No.	Description	Std Carton
PMV0950PT	30 AMP ATC/ATO fuse holder 12 AWG Qty 1	1



Order No.	Description	Std Carton
PMV0961PT	10 AMP fuse holder 16 AWG Qty 1	1
PMV0963PT	20 AMP ATC/ATO fuse holder 12 AWG Qty 1	1



Order No.	Description	Std Carton
PMV0967PT	30 AMP fuse holder 12 AWG Qty 1	1



Order No.	Description	Std Carton
PMV0969PT	60 AMP ATC/ATO fuse holder 8 AWG Qty 1	1



Order No.	Description	Std Carton
PMV0840PT	red & black insul. 30 AMP test Clips Qty 1 set	1



Order No.	Description	Std Carton
PMV1544KT	wire nut blue 22-16 AWG Qty 15	1
PMV1545KT	wire nut orange 18-16 AWG Qty 20	1
PMV1546KT	wire nut yellow 18-12 AWG Qty 8	1



Order No.	Description	Std Carton
PMV1560KT	18-14 AWG quick splice (blue) Qty 5	1
PMV1560PT	18-14 AWG quick splice (blue) Qty 15	1
PMV1560QT	18-14 AWG quick splice (blue) Qty 2	1



Order No.	Description	Std Carton
PMV1100KT	22-16 AWG nylon butt connector Qty 11	1
PMV1100PT	22-16 AWG nylon butt connector Qty 50	1



Order No.	Description	Std Carton
PMV1200KT	16-14 AWG nylon butt connector Qty 11	1
PMV1200PT	16-14 AWG nylon butt connector Qty 50	1



# WIRING & TERMINALS



Order No.	Description	Std Carton
PMV1268KT	16-14 AWG .157" single bullet recept. Qty 7	1



Order No.	Description	Std Carton
PMV1700KT	22-16 AWG vinyl butt connector Qty 20	1
PMV1700PT	22-16 AWG vinyl butt connector Qty 50	1
PMV1700QT	22-16 AWG vinyl butt connector Qty 5	1



Order No.	Description	Std Carton
PMV1725KT	22-16 AWG vinyl #10 spade Qty 18	1



Order No.	Description	Std Carton
PMV1800KT	16-14 AWG vinyl butt connector Qty 20	1
PMV1800PT	16-14 AWG vinyl butt connector Qty 50	1
PMV1800QT	16-14 AWG vinyl butt connector Qty 5	1



Order No.	Description	Std Carton
PMV1806KT	16-14 AWG vinyl 1/4" ring Qty 14	1
PMV1806QT	16-14 AWG vinyl 1/4" ring Qty 3	1

# ELECTRICAL ACCESSORIES



Order No.	Description	Std Carton
PMV1300KT	12-10 AWG nylon butt connector Qty 6	1
PMV1300PT	12-10 AWG nylon butt connector Qty 25	1



Order No.	Description	Std Carton
PMV1705KT	22-16 AWG vinyl #10 ring Qty 20	1



Order No.	Description	Std Carton
PMV1749KT	22-16 AWG vinyl .110" female Qty 18	1
PMV1755KT	22-16 AWG vinyl .250" female Qty 18	1
PMV1755QT	22-16 AWG vinyl .250" female Qty 3	1



Order No.	Description	Std Carton
PMV1804KT	16-14 AWG vinyl #8 ring Qty 20	1
PMV1805KT	16-14 AWG vinyl #10 ring Qty 20	1
PMV1805QT	16-14 AWG vinyl #10 ring Qty 5	1



Order No.	Description	Std Carton
PMV1808KT	16-14 AWG vinyl 5/16" ring Qty 12	1
PMV1808QT	16-14 AWG vinyl 5/16" ring Qty 3	1
PMV1809KT	16-14 AWG vinyl 3/8" ring Qty 10	1

STT

TURN

MARKER

B-U/UTIL

SPEC

EMERG

ECE

MOUNT

ELECT

REFLECT

ACCY

MERCH

TECH

# ELECTRICAL ACCESSORIES

# WIRING & TERMINALS



Order No.	Description	Std Carton
PMV1825KT	16-14 AWG vinyl #10 spade Qty 18	1



Order No.	Description	Std Carton
PMV1855KT	16-14 AWG vinyl .250" female Qty 20	1
PMV1855PT	16-14 AWG vinyl .250" female Qty 100	1
PMV1855QT	16-14 AWG vinyl .250" female Qty 5	1



Order No.	Description	Std Carton
PMV1856KT	16-14 AWG vinyl .250" male Qty 19	1
PMV1856QT	16-14 AWG vinyl .250" male Qty 5	1



Order No.	Description	Std Carton
PMV1858KT	16-14 AWG vinyl .157" bullet Qty 19	1
PMV1858QT	16-14 AWG vinyl .157" bullet Qty 5	1



Order No.	Description	Std Carton
PMV1864KT	16-14 AWG nylon .250" fully insul. male Qty 10	1
PMV1864PT	16-14 AWG nylon .250" fully insul. male Qty 25	1



Order No.	Description	Std Carton
PMV1865KT	16-14 AWG nylon .250" fully insul. female Qty 10	1
PMV1865PT	16-14 AWG nylon .250" fully insul. female Qty 50	1
PMV1865QT	16-14 AWG nylon .250" fully insul. female Qty 2	1



Order No.	Description	Std Carton
PMV1900KT	12-10 AWG vinyl butt connector Qty 14	1
PMV1900PT	12-10 AWG vinyl butt connector Qty 25	1
PMV1900QT	12-10 AWG vinyl butt connector Qty 4	1



Order No.	Description	Std Carton
PMV1905KT	12-10 AWG vinyl #10 ring Qty 14	1
PMV1905QT	12-10 AWG vinyl #10 ring Qty 3	1



Order No.	Description	Std Carton
PMV1906KT	12-10 AWG vinyl 1/4" ring Qty 12	1
PMV1906PT	12-10 AWG vinyl 1/4" ring Qty 25	1
PMV1908KT	12-10 AWG vinyl 5/16" ring Qty 11	1
PMV1908PT	12-10 AWG vinyl 5/16" ring Qty 25	1



Order No.	Description	Std Carton
PMV1909KT	12-10 AWG vinyl 3/8" ring Qty 10	1
PMV1909PT	12-10 AWG vinyl 3/8" ring Qty 25	1
PMV1909QT	12-10 AWG vinyl 3/8" ring Qty 2	1
PMV1913QT	12-10 AWG vinyl 1/2" ring Qty 1	1

# WIRING & TERMINALS



Order No.	Description	Std Carton
PMV1955KT	12-10 AWG vinyl .250" female Qty 15	1
PMV1955QT	12-10 AWG vinyl .250" female Qty 3	1



Order No.	Description	Std Carton
PMV2250GT	22-16 AWG adhesive-filled heat shrink butt conn. Qty 25	1
PMV2250PT	22-16 AWG adhesive-filled heat shrink butt conn. Qty 5	1



Order No.	Description	Std Carton
PMV2270GT	12-10 AWG adhesive-filled heat shrink butt conn. Qty 25	1
PMV2270PT	12-10 AWG adhesive-filled heat shrink butt conn. Qty 5	1



Order No.	Description	Std Carton
PMV4008KT	8 AWG 5/16" brazed ring Qty 5	1



Order No.	Description	Std Carton
PMV4138KT	6 AWG 5/16" tubular ring Qty 2	1
PMV4238KT	4 AWG 5/16" tubular ring Qty 2	1

# ELECTRICAL ACCESSORIES



Order No.	Description	Std Carton
PMV1956QT	12-10 AWG vinyl .250" male Qty 3	1



Order No.	Description	Std Carton
PMV2260GT	16-14 AWG adhesive-filled heat shrink butt conn. Qty 25	1
PMV2260PT	16-14 AWG adhesive-filled heat shrink butt conn. Qty 5	1



Order No.	Description	Std Carton
PMV3157QT	12-10 AWG nylon w/grip .375" female Qty 2	1



Order No.	Description	Std Carton
PMV4050KT	8 AWG insul. lug connector Qty 3	1



Order No.	Description	Std Carton
PMV4239KT	4 AWG 3/8" tubular ring Qty 2	1
PMV4339KT	2 AWG 3/8" tubular ring Qty 1	1
PMV4439KT	1/0 AWG 3/8" tubular ring Qty 1	1
PMV4539KT	2/0 AWG 3/8" tubular ring Qty 1	1

STT

TURN

MARKER

B-U/UTIL

SPEC

EMERG

ECE

MOUNT

ELECT

REFLECT

ACCY

MERCH

TECH

# ELECTRICAL ACCESSORIES

# WIRING & TERMINALS



Order No.	Description	Std Carton
PMV5140PT	black 1/4" convoluted tubing 14'	1
PMV5141PT	black 3/8" convoluted tubing 10'	1
PMV5142PT	black 1/2" convoluted tubing 7'	1
PMV5143PT	black 3/4" convoluted tubing 5'	1



Order No.	Description	Std Carton
PMV7064PT	wht 4" nylon tie wrap 18lb tensile strength Qty 25	1
PMV7066PT	wht 6" nylon tie wrap 50lb tensile strength Qty 25	1
PMV7067PT	wht 11" nylon tie wrap 50lb tensile strength Qty 25	1



Order No.	Description	Std Carton
PMV7074PT	blk 4" nylon tie wrap 18lb tensile strength Qty 25	1
PMV7076PT	blk 6" nylon tie wrap 50lb tensile strength Qty 25	1
PMV7077PT	blk 11" nylon tie wrap 50lb tensile strength Qty 25	1



Order No.	Description	Std Carton
PMV7120QT	1/4" nylon clamp Qty 7	1



Order No.	Description	Std Carton
PMV81101PT	10 AWG red primary wire 10'	1
PMV81121PT	12 AWG red primary wire 12'	1
PMV81141PT	14 AWG red primary wire 20'	1
PMV81161PT	16 AWG red primary wire 25'	1
PMV81181PT	18 AWG red primary wire 35'	1



Order No.	Description	Std Carton
PMV81103PT	10 AWG black primary wire 10'	1
PMV81123PT	12 AWG black primary wire 12'	1
PMV81143PT	14 AWG black primary wire 20'	1
PMV81163PT	16 AWG black primary wire 25'	1
PMV81183PT	18 AWG black primary wire 35'	1



Order No.	Description	Std Carton
PMV81142PT	14 AWG yellow primary wire 20'	1
PMV81162PT	16 AWG yellow primary wire 25'	1



Order No.	Description	Std Carton
PMV81147PT	14 AWG white primary wire 20'	1
PMV81187PT	18 AWG white primary wire 35'	1



Order No.	Description	Std Carton
PMV81164PT	16 AWG green primary wire 25'	1
PMV81145PT	14 AWG blue primary wire 20'	1
PMV81165PT	16 AWG blue primary wire 25'	1
PMV81166PT	16 AWG brown primary wire 25'	1



Order No.	Description	Std Carton
PMV8221PT	1/4" single Wall black Shrink Tubing Qty 4	1
PMV8226PT	assorted Shrink Tubing Qty 4	1



**ECK**  
**Anti-Corrosive Dielectric Grease**



- Protects aluminum and stainless steel against electrolytic reaction.
- Isolates dissimilar metals.
- Dielectric, suitable for use on electrical components.
- Contains anti-seize lubricant.
- 3.75 oz. tube.

Order No.	Description	Pack	Std Carton
PM-ECK-T	3.75 oz.	tube	24



**0099/103T**  
**Dielectric Grease**



- Keeps battery terminals corrosion free.
- Seals High Energy ignition systems.
- Prevents voltage leakage.
- Available in 0.25 ounce and 3 ounce tubes.

Order No.	Description	Pack	Std Carton
PMV0099PT	0.25 oz. tube	Viz Pack	1
PM-103T	3 oz. tube	mfg. pack	60



**0300**  
**Crimping Tool**



- Cuts, strips and crimps 10 ga. to 22 ga. wire.
- Cushioned grips.

Order No.	Description	Pack	Std Carton
PMV0300T	crimping tool	Viz Pack	1



**0690**  
**Circuit Tester**



- Equipped with alligator clip and metal probe.
- Test bulb illuminates inside non-conductive handle.
- Compatible with 6-12 volt circuits.

Order No.	Description	Pack	Std Carton
PMV0690PT	circuit tester	Viz Pack	1



**1575**  
**Test Lead Set**



- Set of two 30" leads.
- Alligator clips on both ends.
- Red and black insulation.

Order No.	Description	Pack	Std Carton
PMV1575PT	test lead set	Viz Pack	1

STT

TURN

MARKER

B-U/UTIL

SPEC

EMERG

ECE

MOUNT

ELECT

REFLECT

ACCY

MERCH

TECH

## CHOOSING SUPERIOR QUALITY CONSPICUITY PRODUCTS IS A CRITICAL SAFETY ENHANCEMENT

*Every trip, every road, whether day or night.*

### NOT ALL REFLECTIVE MATERIALS ARE THE SAME

Road vehicles need more than lighting. Conspicuity tape and retro-reflectors are designed to reflect light back towards the source, no matter what angle it comes from. Unlike the glass beads found in less advanced reflective materials, Peterson conspicuity tapes use **precision-shaped microprisms** that reflect up to 250% more efficiently than bargain tapes. That higher performance is vital over longer distances and when visibility is reduced.

### QUALITY THAT LASTS FOR THE LONG HAUL

There is more to tape performance than just the microprisms we use. The performance of your conspicuity equipment shouldn't degrade over time. Peterson specifies **state-of-the-art backing materials** and **industrial-grade adhesives** to maintain the highest visibility to other motorists long after installation.

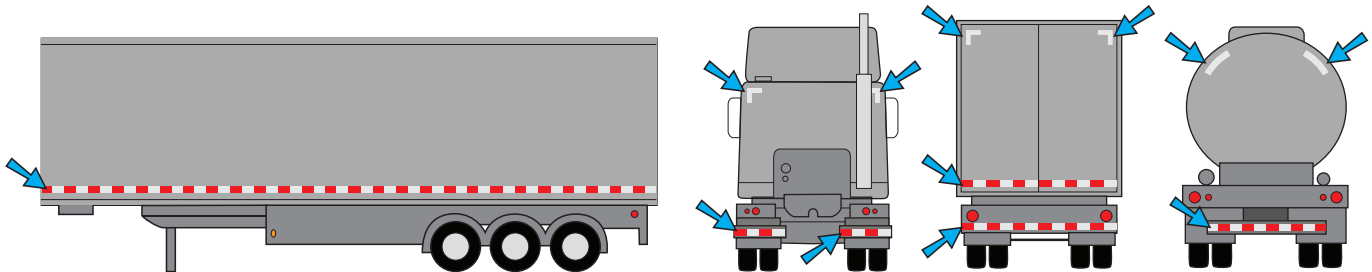

Trailer sides must have one horizontal 2" wide strip or two 1" wide strips of red/white reflective tape running the entire length of the trailer, 15" to 60" above the ground. Either one continuous strip or intermittent strips evenly spaced to cover at least half the length of the trailer is permitted.

At the rear, 2" wide red/white reflective tape must run the width of the trailer. Additionally, 2" wide red/white reflective tape must be placed on the horizontal bar of the underride bumper, as well as 2" x 11.8" (300mm) white strips horizontally and vertically in the upper corners.

## CURRENT FEDERAL REGULATIONS REQUIRE ALL TRAILERS OVER 80" WIDE AND OVER 10,000 POUNDS GVWR TO BE EQUIPPED WITH CONSPICUITY TREATMENT.

### HEAVY DUTY TRUCK & TRAILER FEDERAL CONSPICUITY REQUIREMENTS

*Per FMVSS 108 (49CFR 571.108) – "DOT-C2 compliant"*

**Required** for heavy-duty trucks, trailers, tankers, dump trucks, tow trucks, etc.

**Recommended** for light-duty service bodies, vans and pick-ups.

**Alternating RED/WHITE conspicuity tape is required on all new heavy-duty trailers manufactured after Dec. 1, 1993.**

### APPLICATION LOCATIONS

#### Rear Upper Body

- 12" WHITE strips placed in the upper rear corners

#### Rear Lower Body

- 2" wide RED/WHITE tape placed on rear full width of vehicle
- 2" wide RED/WHITE tape minimum 24" length on fender, mudflap brackets or within 12" below the top of mud flaps

#### Side Marking

- 2" wide RED/WHITE tape placed on each side of trailer continuous or evenly spaced over 50% of the vehicle

## CUSTOM LOGO TAPE

IS AVAILABLE FROM  
**PETERSON!**

**NO first-time art and set-up charges.**

**Minimum order requirement for custom logo tape is 105 rolls per order.**

### HOW TO ORDER

- Contact Peterson Customer Service. Call **816-765-2000** or E-mail [orders@pmlights.com](mailto:orders@pmlights.com) with customer logo art (vector PDF or EPS file) and P.O. for first order.
- First order lead time is 8 weeks from screen approval (not P.O.). Lead time is 2 weeks on second and subsequent orders.
- Free drop ship directly to customer for all custom logo tape P.O.s.
- Additional special orders can be handled with Peterson Customer Service.

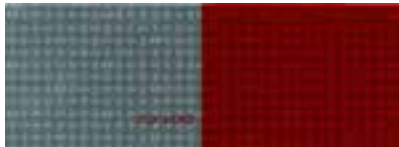

**V82**  
 1000 Candlepower, 10 Year Warranty  
 Single-layer polyester film that is extremely flexible. Cannot delaminate like two-layer tape, so it maintains reflectivity after impact and can be riveted through.  
**Maximum nighttime reflectivity.**

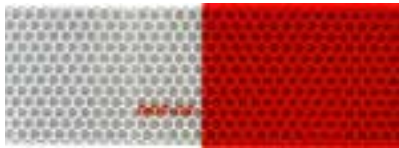

**V59 High Intensity Prismatic (HIP)**  
 10 Year Warranty  
 Air-backed, two-layer High Intensity Prismatic Tape is whiter in daylight than traditional polyester tape. Tape is sealed at edges and must not be punctured, or delamination may occur.  
**Maximum daytime visibility.**

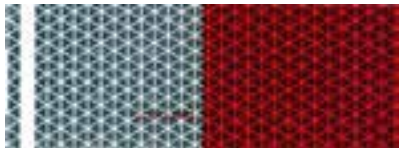

**V92 DAYBRIGHT**  
 600 Candlepower, 5 Year Warranty  
 Single-layer polyester film that is extremely flexible. Cannot delaminate like two-layer tape, so it maintains reflectivity after impact and can be riveted through.  
**DAYBRIGHT white lines in pattern for increased daytime visibility.**



**V42**  
 600 Candlepower, 3 Year Warranty  
 Single-layer polyester film that's a cost effective solution for retrofitting existing trucks and trailers.



**V98**  
 Conformable graphic sheeting meets NFPA 1901 standard, 5 Year Warranty  
 Thin, weather-resistant prismatic tape. Vinyl construction to conform to vehicle shapes and curves. Maintains reflectivity after impact.

**PM** Conspicuity Tape Selection Guide

STYLE		V82 1000 Candlepower	V59 H.I.P.	V92 – 600 CP DAYBRIGHT	V42 600 CP
WARRANTY		10 Years	10 Years	5 Years	3 Years
WIDTH		1" / 1.45"      2"	2"	2"	2"
<b>TAPE ROLLS*</b>	<b>464</b> 6" White x 6" Red		464-2	464-1	
	<b>463</b> 7" White x 11" Red	465-5 (1")	465-2	NEW 465-3	463-1 (30' roll) 465-1 (150' roll)
	<b>465</b> 7" White x 11" Red				NEW 465-4
	<b>467</b> ALL WHITE			467-1	
<b>469</b> YELLOW	469 (1.45")	469-1	NEW 469-3		
<b>TAPE STRIPS</b>	<b>465</b> 7" White x 11" Red			465K (8 pack) 465-4K (4 pack)	
	<b>467</b> ALL WHITE		B486W (24" Curved)	467-4K (4 pack)	
	<b>486</b> ALL WHITE				
<b>468</b> ALL RED				468-1C <sup>†</sup>	

\*All rolls are 150' in length except as noted

<sup>†</sup>For auxiliary use only in USA

- STT
- TURN
- MARKER
- B-U/UTIL
- SPEC
- EMERG
- ECE
- MOUNT
- ELECT
- REFLECT
- ACCY
- MERCH
- TECH

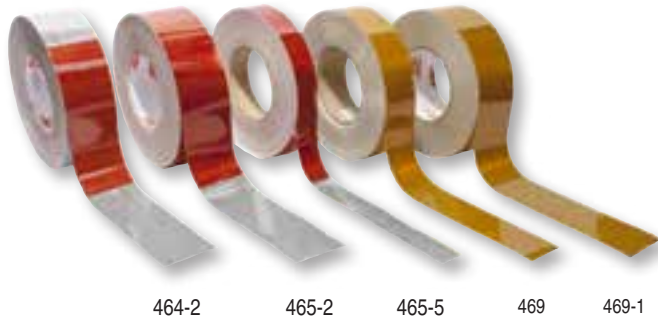

464-2      465-2      465-5      469      469-1

## 10-Year, 1000 Candlepower Polyester Film Tape Rolls



- Ten year warranty.
- UV-stabilized and weather resistant high performance polyester film.
- No edge sealing requirement and can be riveted through.
- Single layer prismatic construction maintains reflectivity after impact.
- Industrial-strength adhesive to mount on flat or curved surfaces.

Order No.	CP	Width	Lgth	Style	Pattern	Pack	Std Carton
464-2	1000	2"	150'	V82	6" white x 6" red	box	1
465-2	1000	2"	150'	V82	7" white x 11" red	box	1
465-5	1000	1"	150'	V82	7" white x 11" red	box	1
469	1000	1.45"	150'	V82	yellow	box	1
469-1	1000	2"	150'	V82	yellow	box	1

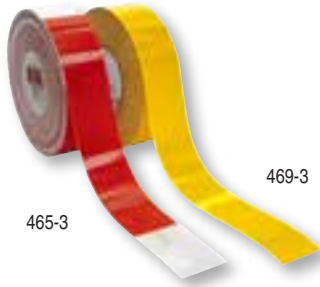

465-3      469-3

## 10-Year, High Intensity Prismatic (HIP) Tape Rolls



- High Intensity Prismatic Tape is whiter in daylight than traditional polyester.
- Air-backed, two-layer tape is sealed at edges.
- Industrial-strength adhesive to mount on flat or curved surfaces.

Order No.	CP	Width	Lgth	Style	Pattern	Pack	Std Carton
465-3	HIP	2"	150'	V59	7" white x 11" red	box	1
469-3	HIP	2"	150'	V59	yellow	box	1

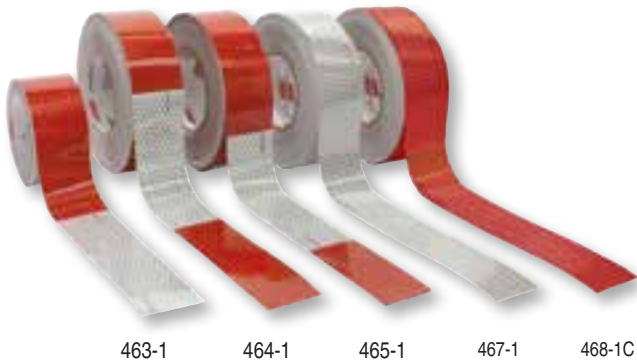

463-1      464-1      465-1      467-1      468-1C

## 5-Year, 600 Candlepower *DAYBRIGHT* Tape Rolls



- White lines in pattern for maximum DAYTIME visibility.
- Five year warranty.
- UV-stabilized and weather resistant high performance polyester film.
- No edge sealing requirement and can be riveted through.
- Single layer prismatic construction maintains reflectivity after impact.
- Industrial-strength adhesive to mount on flat or curved surfaces.
- Each roll contains 150 feet of tape, except 463-1 (which has 30').
- 468-1C is for auxiliary use only in USA.

Order No.	CP	Width	Lgth	Style	Pattern	Pack	Std Carton
463-1	600	2"	30'	V92	7" white x 11" red	box	1
464-1	600	2"	150'	V92	6" white x 6" red	box	1
465-1	600	2"	150'	V92	7" white x 11" red	box	1
467-1	600	2"	150'	V92	all white	box	1
468-1C	600	2"	150'	V92	all red	box	1



## 3-Year, 600 Candlepower Reflective Tape Roll



- Three year warranty.
- UV-stabilized and weather resistant high performance polyester film.
- No edge sealing requirement and can be riveted through.
- Single layer prismatic construction maintains reflectivity after impact.
- Industrial-strength adhesive to mount on flat or curved surfaces.

Order No.	CP	Width	Lgth	Style	Pattern	Pack	Std Carton
465-4	600	2"	150'	V42	7" white x 11" red	box	1





470-1

## Conformable Reflective Graphic Roll



- Five year warranty.
- Weather resistant, high performance, prismatic vinyl.
- Thin, flexible construction conforms to vehicle shapes and curves.
- Compliant to NFPA 1901 standard

Order No.	CP	Width	Lgth	Style	Pattern	Pack	Std Carton
470-1		2"	150'	V98	lime	box	1

STT

TURN

MARKER

B-U/UTIL

SPEC

EMERG

ECE

MOUNT

ELECT

REFLECT

ACCY

MERCH

TECH

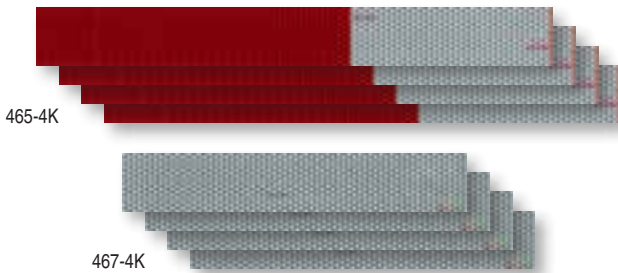

465K

## 5-Year, 600 Candlepower DAYBRIGHT Marking Strips



- High-brightness reflective material rated at 600 candle power.
- UV-stabilized and weather resistant high performance polyester film.
- No edge sealing requirement and can be riveted through.
- Single layer prismatic construction maintains reflectivity after impact.
- Industrial-strength adhesive to mount on flat or curved surfaces.
- Kits contain four or eight strips.

Order No.	CP	Width	Lgth	Style	Pattern	Pack	Std Carton
465K	KIT	600	2"	18"	V92 red/white 8-strip kit	Viz Pack	12
465-4K	KIT	600	2"	18"	V92 red/white 4-strip kit	Viz Pack	12
467-4K	KIT	600	2"	11.8"	V92 all white 4-strip kit	Viz Pack	12

486W

## 10-Year, 1000 Candlepower Tanker Marking Strips



- Reflective material rated at 1000 candle power.
- Tank style white reflector tape.
- Industrial-strength adhesive to mount on flat or curved surfaces.
- 2" wide curved strip.
- Ten year warranty
- Approximately 23.5" long.

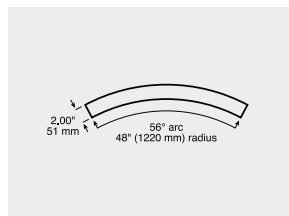

Order No.	CP	Width	Lgth	Style	Pattern	Pack	Std Carton
B486W		1000	2"	23.5"	V82 all white	box	100

## What makes Spitfire® wide angle reflectors so superior?

- 50% wider reflectivity angle than conventional reflectors
- 47,000 microprisms per square inch for superior candle power
- Ultra-thin design—just .012" thick
- Hermetically sealed and unbreakable
- Industrial strength adhesive
- Easy to install on flat or curved surfaces
- Exceed DOT specifications
- Available in amber or red

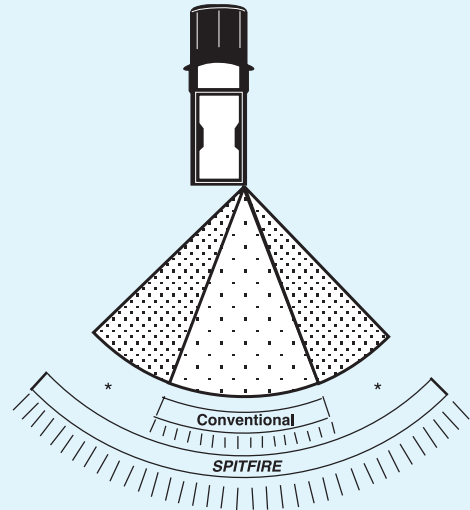

### 493 Spitfire® Pressure-Sensitive Reflector Kit



- Contains two each: 489, 490, 491 reflectors.
- Available in amber or red.
- High-strength, pressure-sensitive backing adhesive.
- Attractive, self-service visual packaging.

Order No.	Description	Pack	Std Carton
V493KA	<b>KIT</b> amber kit	Viz Pack	12
V493KR	<b>KIT</b> red kit	Viz Pack	12



Red and amber Viz Pack kits contain all the reflectors shown at left in attractive, sealed, hangable blister packs.



**489 Spitfire®**  
**Pressure-Sensitive Rectangular Reflector**



- Rectangular reflector measures 2.75" x 1.75" (70 mm x 45 mm).
- High-strength, pressure-sensitive backing adhesive.
- Meets FMVSS 108 requirements.

Order No.	Description	Pack	Std Carton
489A	amber (6 reflectors per bag)	poly pack	12
489R	red (6 reflectors per bag)	poly pack	12
B489A	amber	mfg. pack	100
B489R	red	mfg. pack	100

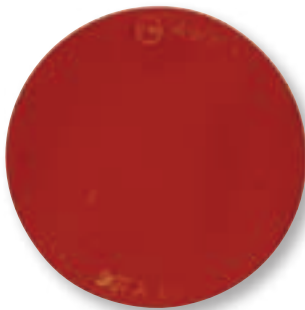

**490 Spitfire®**  
**Pressure-Sensitive Round Reflector**



- Round reflector measures 2.88" (73 mm) diameter.
- High-strength, pressure-sensitive backing adhesive.
- Meets FMVSS 108 requirements.

Order No.	Description	Pack	Std Carton
490A	amber (6 reflectors per bag)	poly pack	12
490R	red (6 reflectors per bag)	poly pack	12
B490A	amber	mfg. pack	100
B490R	red	mfg. pack	100



**491 Spitfire®**  
**Pressure-Sensitive Rectangular Reflector**



- Rectangular reflector measures 4.31" x 1.69" (110 mm x 43 mm).
- High-strength, pressure-sensitive backing adhesive.
- Meets FMVSS 108 requirements.

Order No.	Description	Pack	Std Carton
491A	amber (6 reflectors per bag)	poly pack	12
491R	red (6 reflectors per bag)	poly pack	12
B491A	amber	mfg. pack	100
B491R	red	mfg. pack	100



**492 Spitfire®**  
**Pressure-Sensitive Rectangular Reflector**



- Rectangular reflector measures 4.31" x 13/16" (110 mm x 21 mm).
- High-strength, pressure-sensitive backing adhesive.
- Ideal for applications where space is minimal.
- **For auxiliary use only.** Does not feature labeling required to meet FMVSS 108 requirements.

Order No.	Description	Pack	Std Carton
B492A	amber	mfg. pack	100
B492R	red	mfg. pack	100

STT

TURN

MARKER

B-U/UTIL

SPEC

EMERG

ECE

MOUNT

ELECT

REFLECT

ACCY

MERCH

TECH

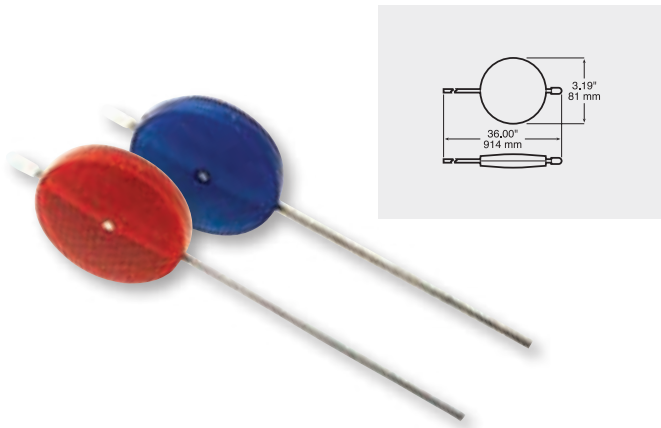

## 461 Driveway Marker



- 3" diameter, double-sided, acrylic reflector.
- 3/16" galvanized steel post.
- Available with 36" or 48" post lengths.
- Available in red or blue.

Order No.	Description	Pack	Std Carton
461B	36" blue	box	6
461R	36" red	box	6
461B-48	48" blue	box	12
461R-48	48" red	box	12



## 460 Steel Oval Reflector



- 3 1/4" diameter acrylic lens.
- Bright-plated, heavy-gauge steel housing.
- Two-piece construction features double strength lens guard.
- Available in amber or red.

Order No.	Description	Pack	Std Carton
B460A	amber	mfg. pack	100
B460R	red	mfg. pack	100



## 472 Aluminum Oval Reflector



- 3" diameter acrylic lens.
- Low-profile, oval housing constructed of rustproof aluminum.
- V472 series contains one reflector per Viz Pack.
- Meets FMVSS 108 standards.
- Available in amber or red.

Order No.	Description	Pack	Std Carton
V472A	amber	Viz Pack	12
V472R	red	Viz Pack	12
B472A	amber	mfg. pack	100
B472R	red	mfg. pack	100



## 474 2" Accessory Reflector

- 2" diameter.
- Stick-on reflector with adhesive back.
- Attractive chrome bezel.
- Ideal for dressing up cars, boats, bicycles and motorcycles.
- For accessory use only; does not meet FMVSS 108 requirements.
- Available in amber or red.

Order No.	Description	Pack	Std Carton
B474A	amber	mfg. pack	100
B474R	red	mfg. pack	100

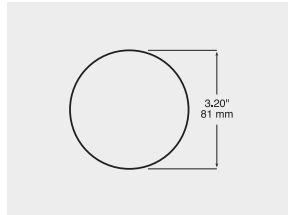

## 475

### Round Quick-Mount Reflector



- 3 3/16" diameter acrylic lens.
- Adhesive backing permanently mounts to any clean, flat surface.
- V475 series contains one reflector per Viz Pack.
- Meets FMVSS 108 standards.
- Available in amber or red.

Order No.	Description	Pack	Std Carton
V475A	amber	Viz Pack	12
V475R	red	Viz Pack	12
B475A	amber	mfg. pack	100
B475R	red	mfg. pack	100

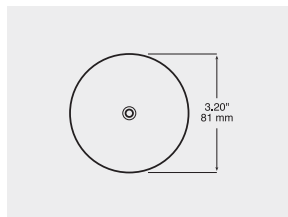
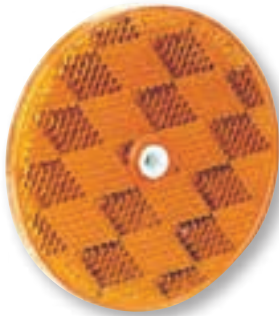

## 476

### Round Center-Mount Reflector

- 3 3/16" diameter.
- Hermetically sealed.
- Center screw mounting.
- 3/16" diameter mounting hole.
- Meets FMVSS 108 standards.
- Available in amber or red.
- Poly bags contain two reflectors per pack.

Order No.	Description	Pack	Std Carton
476A	amber, qty. 2	poly pack	12
476R	red, qty. 2	poly pack	12
B476A	amber	mfg. pack	100
B476R	red	mfg. pack	100

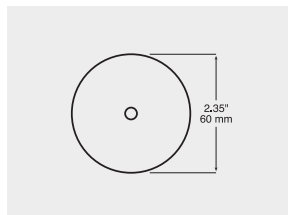

## 477

### Round Center-Mount Reflector

- 2 3/8" diameter.
- Hermetically sealed.
- Center screw mounting.
- 1/4" diameter mounting hole.
- Perfect for any surface area where space is limited.
- Meets FMVSS 108 standards.
- Available in amber or red.
- Poly bags contain two reflectors per pack.

Order No.	Description	Pack	Std Carton
477A	amber, qty. 2	poly pack	12
477R	red, qty. 2	poly pack	12
B477A	amber	mfg. pack	100
B477R	red	mfg. pack	100

STT

TURN

MARKER

B-U/UTIL

SPEC

EMERG

ECE

MOUNT

ELECT

REFLECT

ACCY

MERCH

TECH

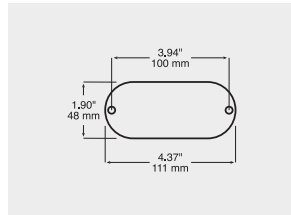
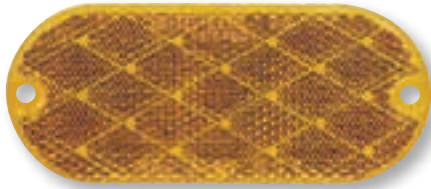

479

Oblong Reflector

- 4 3/8" x 1 7/8" reflector.
- Hermetically sealed acrylic lens.
- Mounts on 3 15/16" centers.
- Meets FMVSS 108 standards.
- Available in amber or red.

Order No.	Description	Pack	Std Carton
B479A	amber	mfg. pack	100
B479R	red	mfg. pack	100

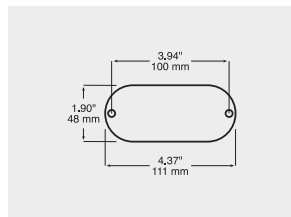

480

Oblong Quick-Mount Reflector



- 4 3/8" x 1 7/8" acrylic lens.
- Adhesive backing permanently mounts to any clean, flat surface.
- V480 series contains two reflectors per Viz Pack.
- May also be mounted on 3 15/16" centers.
- Meets FMVSS 108 standards.
- Available in amber or red.

Order No.	Description	Pack	Std Carton
V480A	amber	Viz Pack	6
V480R	red	Viz Pack	6
B480A	amber	mfg. pack	100
B480R	red	mfg. pack	100

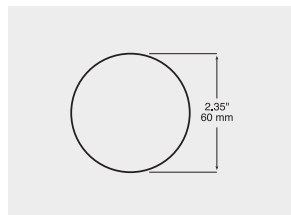
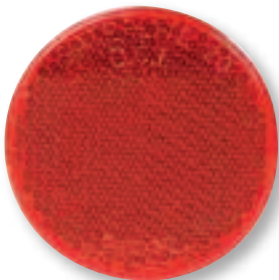

481

Round Quick-Mount Reflector

- 2 3/8" acrylic reflector.
- Permanent adhesive backing.
- Ideal for applications where space is minimal.
- Meets FMVSS 108 standards.
- Available in amber or red.
- Poly bags contain two reflectors per pack.

Order No.	Description	Pack	Std Carton
481A	amber, qty. 2	poly pack	12
481R	red, qty. 2	poly pack	12
B481A	amber	mfg. pack	100
B481R	red	mfg. pack	100

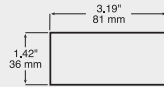

## 483

### Rectangular Quick-Mount Reflector



- 3 1/8" x 1 3/8" stick-on reflector.
- Adhesive back for quick and permanent mounting.
- V483 series contains two reflectors per Viz Pack.
- Meets FMVSS 108 standards.
- Available in amber or red.

Order No.	Description	Pack	Std Carton
V483A	amber	Viz Pack	12
V483R	red	Viz Pack	12
B483A	amber	mfg. pack	100
B483R	red	mfg. pack	100

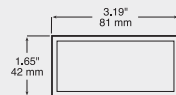

## 484

### Rectangular Quick-Mount Reflector

- 3 7/16" x 1 11/16" stick-on reflector.
- Encased in attractive chrome bezel.
- Adhesive back allows quick and permanent mounting.
- Meets FMVSS 108 standards.
- Available in amber or red.

Order No.	Description	Pack	Std Carton
B484A	amber, chrome	mfg. pack	100
B484R	red, chrome	mfg. pack	100

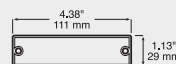

## 487

### Compact Rectangular Reflector



- 4 3/8" x 1 1/8" acrylic reflector.
- Features both adhesive backing and mounting holes.
- Perfect for many narrow mounting locations.
- V487 series contains two reflectors per Viz Pack.
- Meets FMVSS 108 standards.
- Available in amber or red.

Order No.	Description	Pack	Std Carton
V487A	amber	Viz Pack	12
V487R	red	Viz Pack	12
B487A	amber	mfg. pack	100
B487R	red	mfg. pack	100

STT

TURN

MARKER

B-U/UTIL

SPEC

EMERG

ECE

MOUNT

ELECT

REFLECT

ACCY

MERCH

TECH

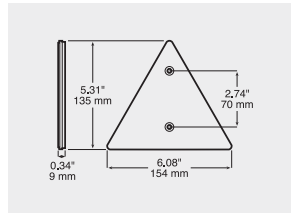

1274

## ECE-Compliant Triangular Rear Reflector



- Meets applicable ECE requirements for trailer use.
- High-strength foam adhesive backing, or equipped with holes for screw mounting.

Order No.	Description	Pack	Std Carton
1274R	triangular reflector	poly pack	25

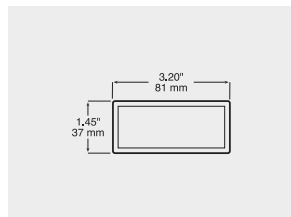

1284

## ECE-Compliant Reflector



- 81 mm x 37 mm (3.2" x 1.45").
- Meets applicable ECE requirements.
- Available in amber, red, and white.

Order No.	Description	Pack	Std Carton
1284A	amber	mfg. pack	250
1284R	red	mfg. pack	250
1284W	white	mfg. pack	250

2753

## ECE-Compliant Reflector



- 56 mm (2.19").
- Meets applicable ECE requirements.

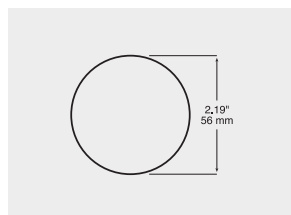

Order No.	Description	Pack	Std Carton
2753A	amber	mfg. pack	100
2753R	red	mfg. pack	100

ECE-approved products are made available for use in export markets that require Economic Commission for Europe (ECE) compliant equipment.





449

## Warning Triangle Kit



- Kit contains three folding warning triangles and 20" x 5" x 5" corrosion-free plastic storage box.
- One-piece triangles feature "living hinges" with foldout tabs that lock together.
- Heavy base and non-skid tabs withstand 40 MPH winds.
- Bright fluorescent orange color and high-efficiency reflectors for maximum visibility day or night.
- Meets FMVSS 125.

Order No.	Description	Pack	Std Carton
449	complete kit	box	1
449-1	kit, drop ship	box	72

459

## SMV Emblems



- Standard type warning emblems for slow moving vehicles.
- Bright reflective edge strips and fluorescent orange center.
- Meets ASAE standard S276.5.
- 459 features corrosion-proof backing plate and hardware for either spade or bracket mounting.
- 459-1 features industrial-strength mounting adhesive for flush, no-drill mounting and mounting on slightly curved surfaces.

Order No.	Description	Pack	Std Carton
459	emblem w/ back plate	box	1
459-1	adhesive emblem	box	12

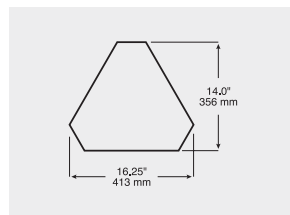

STT  
TURN  
MARKER  
B-U/UTIL  
SPEC  
EMERG  
ECE  
MOUNT  
ELECT  
REFLECT  
ACCY  
MERCH  
TECH

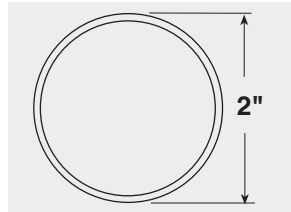

**600**  
**2" Round Blind-Spot Mirror**



- 2" diameter convex glass mirror.
- Aluminum housing.
- Adhesive backing mounts to any smooth, flat surface.
- Packaged one per display card.

Order No.	Description	Pack	Std Carton
V600	aluminum	Viz Pack	12

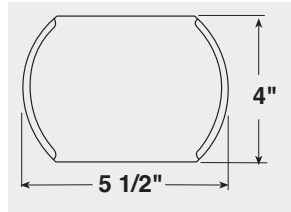

**602**  
**Rectangular Blind-Spot Mirror**



- 4" x 5 1/2" convex glass mirror.
- Aluminum housing.
- Adhesive backing mounts to any smooth, flat surface.
- Packaged one per display card.

Order No.	Description	Pack	Std Carton
V602	aluminum	Viz Pack	12

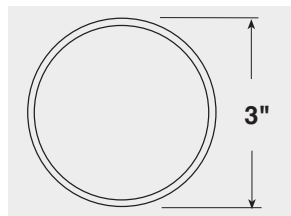

**603**  
**Round Blind-Spot Mirrors**



- 3" diameter convex glass mirror.
- Aluminum housing.
- Adhesive backing mounts to any smooth, flat surface.
- Packaged one per display card.

Order No.	Description	Pack	Std Carton
V603	aluminum 3" dia.	Viz Pack	12

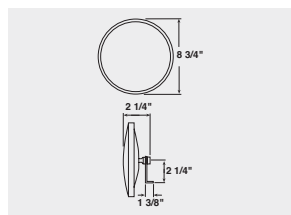

**608**  
**8" Convex Mirror**

- 8" diameter convex glass mirror.
- Adjustable ball stud with 5/16" internal thread.
- Includes bright plated right angle bracket.
- Bright stainless or durable black enamel finish.
- Packaged in see-through display box.

Order No.	Description	Pack	Std Carton
608	black	display box	6
608X	bright stainless	display box	6

# CONVEX MIRRORS

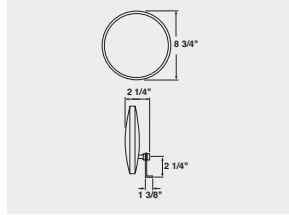

## 608

### Offset Mount 8" Convex Mirror

- 8" diameter convex glass mirror.
- Offset stud allows positioning below West Coast-style mirrors.
- Includes bright plated right angle bracket.
- Bright stainless steel finish.
- Packaged in see-through display box.

Order No.	Description	Pack	Std Carton
608XO	bright stainless	display box	6

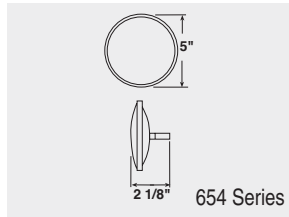

## 654/655

### Steel Clamp-On Convex Mirrors

- Convex glass mirror available in 5" and 6" diameters.
- Durable black enamel or stainless steel finish.
- Includes clamp-on, right-angle mounting arm and angle bracket.
- Mounts below West Coast mirror, or clamps to any tubular bracket.
- Packaged in see-through display box.

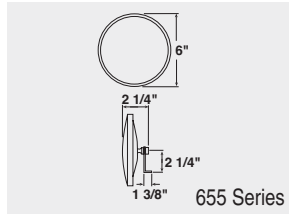

Order No.	Description	Pack	Std Carton
654	5" dia. black	display box	12
654X	5" dia. stainless	display box	12
655	6" dia. black	display box	12
655X	6" dia. stainless	display box	12

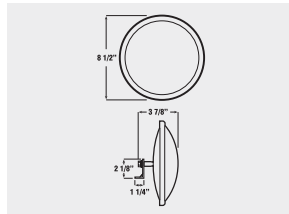

## 658

### 8" Fisheye Convex Mirror

- Highly convex mirror provides wide-angle fisheye view.
- Extra-large 8" diameter.
- Durable stainless steel finish.
- Includes angle bracket.
- Packaged in see-through display box.

Order No.	Description	Pack	Std Carton
658X	bright stainless	display box	6

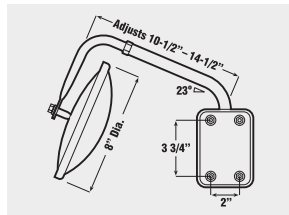
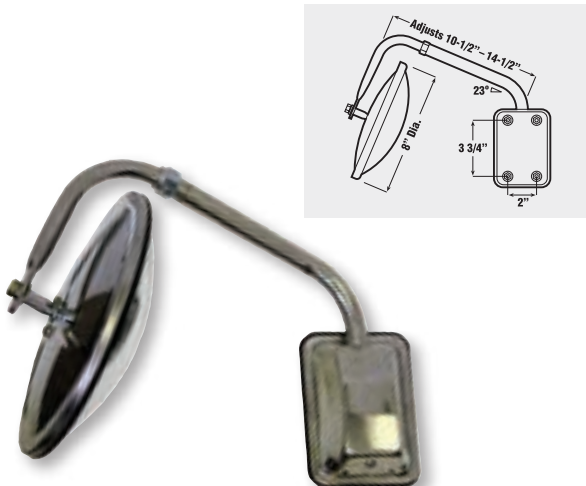

## 668

### Pod-Mount Truck Mirror

- 8" convex glass mirror.
- Single arm adjustment is quick, easy and secure.
- Durable stainless steel finish.
- Pod base mounts easily to any flat surface.
- Packaged in see-through display box.
- Accepts 658X as replacement mirror head.

Order No.	Description	Pack	Std Carton
668X	bright stainless	display box	6

STT  
TURN  
MARKER  
B-U/UTIL  
SPEC  
EMERG  
ECE  
MOUNT  
ELECT  
REFLECT  
ACCY  
MERCH  
TECH

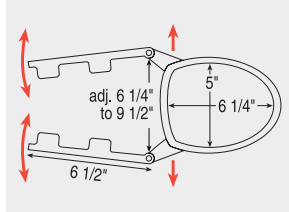

650

Quick-Fit Towing Mirror

- Provides increased viewing area.
- Does not obstruct stock mirror.
- Fits driver or passenger side mirror.
- Double-pivoting adjustable arms attach to nearly all mirrors.
- No-mar flexible rubber straps protect vehicle finish and ensure snug, vibration-free fit.
- Attaches and removes in seconds without tools.

Order No.	Description	Pack	Std Carton
650	black	display box	6

598/805

Universal Day/Night Rearview Mirrors



- OEM-styled, universal interior rearview mirror for cars and trucks.
- Available in 8" or 10" widths.
- Non-glare/nighttime adjustment switch.
- Black ABS housing.
- Adhesive not included.
- Packaged in full-view clamshell.

Order No.	Description	Pack	Std Carton
598	10"	Viz Pack	6
805	8"	Viz Pack	6

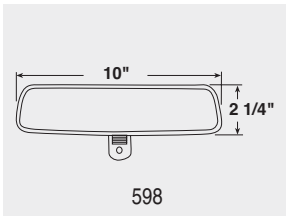

598

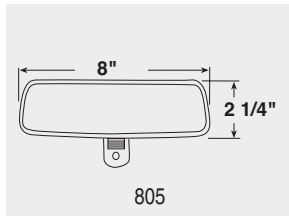

805

605

5" Round Mirror

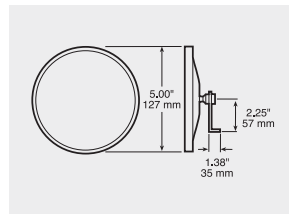

- 5" diameter flat glass mirror.
- Adjustable ball stud with 5/16" internal thread.
- Includes bright plated right angle bracket.
- Durable black enamel finish.
- Packaged in see-through display box.

Order No.	Description	Pack	Std Carton
605	black	display box	12

807

Wide-Angle Safety Mirror



- 5-panel mirror design provides broader, safer viewing area.
- Fits most full-size cars, trucks, and vans.
- Special glass eliminates night glare.
- Includes all mounting hardware.

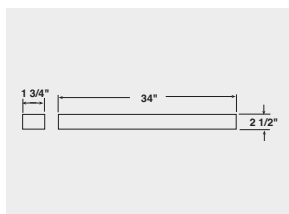

Order No.	Description	Pack	Std Carton
807	5 panel	display box	6

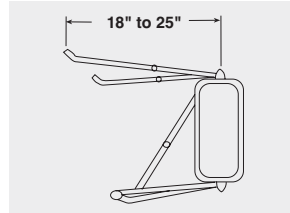

## 667

### Pillow-Back Mirror Assembly

- Fully adjustable West Coast mirror assembly.
- Pillow-back, steel mirror head.
- Domed end caps assure rigidity and protect glass.
- Sturdy 3/4" arms and brace reduce flutter and vibration.
- 18" to 25" horizontal adjustment.
- Bright stainless steel finish.
- Uses replacement mirror head 617X.

Order No.	Description	Pack	Std Carton
667X	stainless steel	display box	6

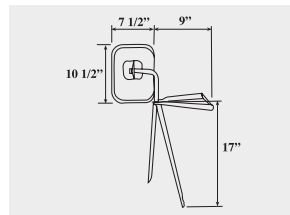

## 810

### Universal Swing-Away Mirror

- Bracket assembly fits most passenger car and light trucks.
- Stainless steel mirror head and arms.
- Rubber tips on attachment points of arms protect vehicle finish.
- Packaged in attractive display box.

Order No.	Description	Pack	Std Carton
810	stainless	display box	6
832	replacement head	Viz Pack	6

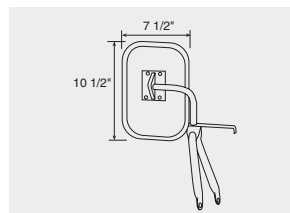

## 820/821

### Universal Swing-Away Mirror

- Universal tripod mount fits Chevrolet, GMC, Ford, and others.
- Reversible for left and right hand application.
- Large mirror head features swing away design.
- 820 has black ABS head and epoxy coated steel arms.
- 821 features all stainless-steel construction.
- Packaged in attractive display, blister box.

Order No.	Description	Pack	Std Carton
820	black	display box	6
821	bright stainless	display box	6
832	stainless replacement head	Viz Pack	6

STT

TURN

MARKER

B-U/UTIL

SPEC

EMERG

ECE

MOUNT

ELECT

REFLECT

ACCY

MERCH

TECH

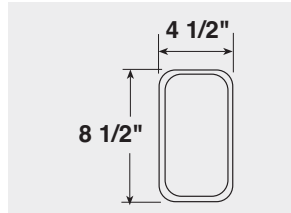

609

Universal Replacement Mirror Head

- Replacement mirror head fits nearly all stud-mount bracket.
- Features white enamel finish and vinyl cushioned glass.
- Rugged, double-washer tensioning for secure positioning.
- Features 1/4" x 1 1/2" offset ball stud.

Order No.	Description	Pack	Std Carton
609	white	display box	24

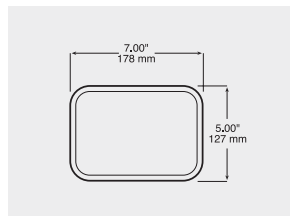

830

Replacement Head for Fender-Mount Mirrors



- Stainless steel mirror head.
- Replacement for many universal-fit fender-mount towing mirror assemblies.

Order No.	Description	Pack	Std Carton
830	stainless replacement head	Viz Pack	6

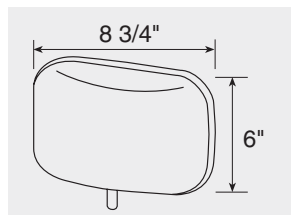

835/836

Low-Mount Replacement Mirror Head



- Replacement head for low-mount mirrors on full-size trucks and vans.
- Reversible for both left- and right-hand applications.
- Mirror head features durable, corrosion-free ABS construction.
- Available with black or chrome finish.
- Packaged in full-view clamshell.

Order No.	Description	Pack	Std Carton
836	chrome replacement head	Viz Pack	6
B835	black replacement head	mfg. pack	16

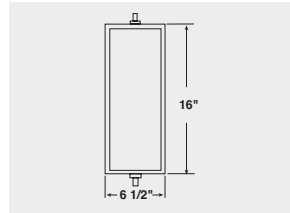

## 615

### 6 1/2" x 16" Economy Replacement Mirror

- Replacement mirror head fits West Coast-style brackets.
- Durable anodized aluminum back with black aluminum end caps.
- 1/4" mounting studs.
- Angled back style.
- Packaged in see-through display box.

Order No.	Description	Pack	Std Carton
615	aluminum	display box	6

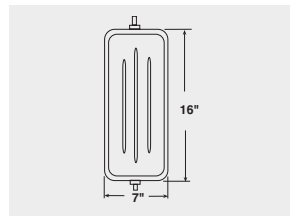

## 616

### 7" x 16" Flat Ribbed-Back Replacement Mirror

- Universal OEM-style, West Coast replacement mirror head.
- One-piece design with cushioned glass.
- 5/16" mounting studs.
- Available in black or white enamel finish.
- Packaged in see-through display box.

Order No.	Description	Pack	Std Carton
616	black	display box	6
616W	white	display box	6

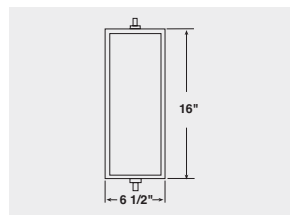

## 617

### 6 1/2" x 16" Pillow-Back Replacement Mirror

- Universal OEM-style, West Coast replacement mirror head.
- 5/16" center rod.
- Bright, stainless-steel finish.
- Packaged in see-through display box.

Order No.	Description	Pack	Std Carton
617X	stainless steel	display box	6

STT

TURN

MARKER

B-U/UTIL

SPEC

EMERG

ECE

MOUNT

ELECT

REFLECT

ACCY

MERCH

TECH



**95010/95011**  
**Universal Rubber-Mast Antennas**



- 13" single-section, flexible, rubberized antennas fit most vehicles.
- Available in either top or combination top/side mount.
- Includes swivel base and 54" cable.
- Some applications may require extension cable.

Order No.	Description	Pack	Std Carton
95010-1	top mount, black	Viz Pack	6
95011-1	top/side mount, black	Viz Pack	6
95093-1	144" extension cable	Viz Pack	12

**95020**  
**Universal Stainless Steel Antenna**



- Universal top-mount design.
- Three-section, 38" stainless steel mast.
- Base mounts on 0-30° angle.
- Includes 47" cable.
- Some applications may require extension cable.

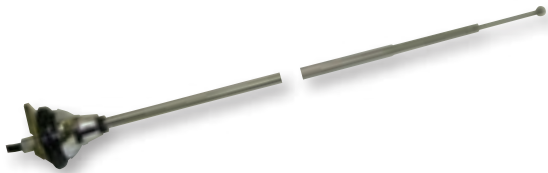

Order No.	Description	Pack	Std Carton
95020-1	stainless steel	Viz Pack	6
95093-1	144" extension cable	Viz Pack	12

**95021/95083/95087**  
**Universal Stainless Steel Antenna**



- Universal top-mount design.
- Single-section, 31" mast.
- Stainless steel mast.
- Includes 47" cable.
- Some applications may require extension cable.

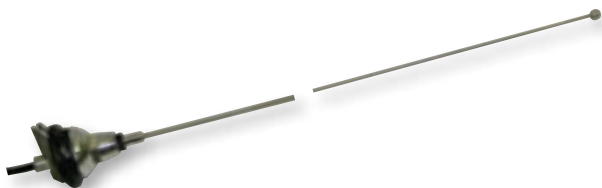

Order No.	Description	Pack	Std Carton
95021-1	stainless steel	Viz Pack	6
95083-1	black replacement mast	Viz Pack	12
95087-1	stainless replacement mast	Viz Pack	12
95093-1	144" extension cable	Viz Pack	12



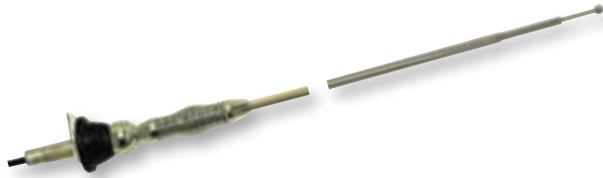

95023

## Universal Stainless Steel Antenna



- Universal top- or side-mount design with swivel base.
- Spring-mounted, three-piece 50" stainless steel mast.
- Includes 47" cable.
- Some applications may require extension cable.

Order No.	Description	Pack	Std Carton
95023-1	stainless steel	Viz Pack	6
95093-1	144" extension cable	Viz Pack	12



95051

## Fully Automatic AM/FM Antenna



- 30" five-section, stainless steel mast.
- Automatically extends when AM/FM radio is turned on.
- Three mounting heads for universal application.
- Waterproof motor.
- Includes 47" cable.
- 12.5" inches of vertical space is required for installation.

Order No.	Description	Pack	Std Carton
95051-1	stainless steel	Viz Pack	6

95093

## Antenna Extension Cable



- Universal extension cables include plug and jack.



Order No.	Description	Pack	Std Carton
95093-1	144" extension cable	Viz Pack	12

STT

TURN

MARKER

B-U/UTIL

SPEC

EMERG

ECE

MOUNT

ELECT

REFLECT

ACCY

MERCH

TECH



**62**  
**Bearing Protectors**



- Protects against premature bearing failure.
- Automatically feeds grease to the wheel bearing.
- Corrosion-proof, clear polycarbonate housing allows easy monitoring of grease level.
- Stainless steel pressure spring and heavy duty pressure plate.
- Overload outlet prevents component damage when refilling.

Order No.	Description	Pack	Std Carton
B62	1.980" dia.	mfg. pack	200

**549 Nightwatcher® LX**  
**100 Watt Halogen Bulb**



- 100 watt, 12 volt replacement bulb.
- Fits all halogen auxiliary lights using H3 bulb.
- Fits blade and bullet terminals.
- Off road use only.
- Self-service Viz Pack packaging.

Order No.	Description	Pack	Std Carton
VH549	replacement bulb	Viz Pack	12

**550 Nightwatcher® LX**  
**55 Watt Halogen Bulb**









- 55 watt, 12 volt replacement bulb.
- Fits all halogen auxiliary lights using H3 bulb.
- Fits blade and bullet terminals.
- 70 watt, 24 volt version also available.
- Self-service Viz Pack packaging.





Order No.	Description	Pack	Std Carton
VH550	replacement bulb	Viz Pack	12
H3-70W-24V	24 volt version	mfg. pack	1





# REPLACEMENT BULBS





# RELATED ACCESSORIES

**NOTE! Bulbs noted as "for reference only" are not stocked by Peterson, and should be procured locally.**

					
1.44"	2.0"	1.44"	1.06"	1.06"	2.125"
<b>67 — reference only</b>	<b>93 — reference only</b>	<b>97 — reference only</b>	<b>168/464 — reference only</b>	<b>193/194 — reference only</b>	<b>795/796 — reference only</b>
13.5 V, 0.59 amp, 4 cp	14 V, 1.04 amp, 15 cp	13.5 V, 0.69 amp, 4 cp	168: 14 V, 0.35 amp, 3 cp 464: 28 V, 0.17 amp, 3 cp	193: 14 V, 0.30 amp, 2 cp 194: 14 V, 0.25 amp, 1.5 cp	795: 12.8 V, 35 watt, 60 cp 796: 12.8 V, 50 watt, 108 cp

				
1.75"	2.0"	2.0"	2.0"	1.07"
<b>1003 — reference only</b>	<b>1141 — reference only</b>	<b>1156 — reference only</b>	<b>1157 — reference only</b>	<b>1895 — reference only</b>
12.8 V, 1.17 amp, 15 cp	12.8 V, 28 watt, 21 cp	12.8 V, 2.1 amp, 32 cp	Twin filmnt, 12.8/14 V, 2.2/0.59 amp, 32/3 cp	14 V, 0.27 amp, 2 cp

				
2.0"	2.0"	2.10"	4.50"	2.25"
<b>2057 — reference only</b>	<b>2357 — reference only</b>	<b>3157 — reference only</b>	<b>4411 — reference only</b>	<b>1195 — reference only</b>
Twin filmnt, 12.8/14 V, 2.1/0.48 amp, 32/2 cp	Twin filaments, 12.8/14 V, 2.2/0.59 amp, 40/3 cp	Twin filaments, 12.8/14 V, 0.59/0.16 amp, 32/3 cp	12.8 V, 2.34 amp, 35000 cp PAR 36, 11° horiz/4° vert beam	14 V, 3.0 amp, 50 cp

			
2.66"	2.75"	3.0"	3.875"
<b>H1/55W</b>	<b>L2-77/L2X-77</b>	<b>L3-77</b>	<b>L7-77</b>
3.0 amp, 14 V, 50 cp	L2-77: Fits 765, 769 & 769-1 L2X-77: Fits 769-2	Fits 789 strobe beacon	Fits 790 & 793 strobe beacons

				
1.25"	1.44"	1.5"	1.5"	1.5"
<b>585-77</b>	<b>STU15AM-77</b>	<b>VH549</b>	<b>VH550</b>	<b>H3-70W-24V</b>
Fits 788 strobe light	Fits 787 strobe light	12 V, 100 watts, 5 amp	12 V, 4.58 amps, 55 watt <i>Not for use on 408, 502 &amp; 503 Series</i>	VH550 repl. for 24V systems

- STT
- TURN
- MARKER
- B-U/UTIL
- SPEC
- EMERG
- ECE
- MOUNT
- ELECT
- REFLECT
- ACCY
- MERCH
- TECH

# RELATED ACCESSORIES

# REPLACEMENT BULBS

PM #	Bulb Type
100	193 or 194
102	193 or 194
104	193 or 194
104-3	193 or 194
106	193 or 194
107	193 or 194
107-24	464
107-3	193 or 194
108	193 or 194
109	97
110	193 or 194
114	193 or 194
115	193 or 194
117	67F
118	97
119	168
120	193 or 194
120-24	464
122	193 or 194
122-24	464
123	97
124	193 or 194
125	193 or 194
126	193 or 194
128	193 or 194
130	193 or 194
130-24	464
131	193 or 194
132	193 or 194
135	193 or 194
136	193 or 194
136-3	193 or 194
137	193 or 194
138	193 or 194
138-24	464
139	193 or 194
159	193 or 194
305	1156
306	2057
313R	1156
313AA	2057
313-2	2057
320	2357
321	2357
324	2357
325	2357
326	2357
334-2	2057
335	2057

PM #	Bulb Type
335-2	2057
337	2057
337-2	2057
339-2	1157
343	3157
344	3157
375	1003
376	1003
377	1003
378	1003
380	1141
382	1141
383	1141
384	93
385	93
389	1141
390	1141
391	1141
392	1156
392-24	1683
393A	1156
393C	1141
394	1141 (21 cp) 1156 (32 cp) 1195 (50 cp)
395	1156
396	912
400	168
408	VH550
410-2	1157
411	1156
411-24	1683
413	1157
413-24	1683
413-3	1157
419	1157 (stop/tail) 1156 (turn)
419-24	P21/5W
425	1157
425-3	1157
428	1157
430	1157
433	193 or 194
434	193 or 194
435	193 or 194
436	168
437	67
438	193
440	1157 (stop/tail)

PM #	Bulb Type
	1895 (side)
441	1157 (stop/tail) 1895 (side)
442	1157 (stop/tail) 1156 (back-up)
444	1157 (stop/tail) 193/194 (side)
445	1157 (stop/tail) 1156 (back-up)
451	1157 (stop/tail) 193/194 (side)
452	1157 (stop/tail) 193/194 (side)
454	1157 (stop/tail) 1156 (back-up)
456	1157 (stop/tail) 193/194 (side)
457	1157
502	VH550
503	VH550
504	VH550
504M	VH550
505	HP6545 (head) 2357 (turn)
507	PAR 36
508	PAR 36
509	H9411
511	PAR 36
513	VH550
517	VH550
525	VH550
526	VH550
527	VH550
529	VH550
530	VH549
531	VH549
534	VH550
538	VH550
539	VH549
552	VH550
555	1157
556	VH550
557	VH550
562	VH550
566	VH550
580	VH549
582	VH550
583	VH550
588	VH550

PM #	Bulb Type
590	VH550
593	VH550
597	VH550
746	1195
753	H1/55W
754	4416
755	4416
756	1195
757	795
759	4416
760	L3-77
761	795
763	1195
765	L2-77
769	L2-77
769-1	L2-77
769-2	L2X-77
771	1141
773	1141
774	1141
775	H1/55W
776	H1/55W
777	H1/55W (rot.) 1156 (stat.)
787	STU15-77
788	STRA-77
789	L3-77
790	L7-77
792	L3-77
793	L7-77
2546	193 or 194
2547	193 or 194
2549	193 or 194
25911	1157
25912	1157 (stop/tail) 1156 (back-up)
25913	1157
25914	1157 (stop/tail) 1156 (back-up)
25921	1157
25922	1157 (stop/tail) 1156 (back-up)
25923	1157
25924	1157 (stop/tail) 1156 (back-up)

# REPLACEMENT LENSES

# RELATED ACCESSORIES



Fits old style 114/AR, 115 A/R, 440/L & 441/L		
amber	55-15A	
red	55-15R	



Fits 452 & 452L		
red	56-15R	



Fits 100A/R, 104A/R, 104-3R, 131A/R & 141A/R		
amber	100-15A	B100-15A
red	100-15R	B100-15R



Fits 102A/R		
amber	102-15A	
red	102-15R	



Fits 107WA/WB/WG/WR, 107-6A/6R, 107-3A/3R			
amber	107-15A	B107-15A	V107-15A
blue	107-15B		
red	107-15R	B107-15R	V107-15R



Fits 106A/R & 108WA/WR			
amber	108-15A	B108-15A	V108-15A
red	108-15R	B108-15R	V108-15R
<i>Fits lights manufactured prior to 2012</i>			

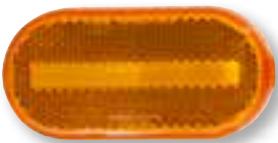

Fits 108		
amber	108-151A	B108-151A
red	108-151R	B108-151R
<i>Fits lights manufactured prior 2012-2018</i>		



Fits 109A	
amber	109-25A



Fits 110A/B/C/G/R, 111R		
amber	110-15A	V110-15A
blue	110-15B	
clear	110-15C	
green	110-15G	
red	110-15R	V110-15R



Fits 112A, new style 114A/R, 115A/R, 440 & 440L, 441 & 441L		
amber	114-15A	
red	114-15R	



Fits 117A	
amber	117-25



Fits 118A/KA	
amber	118-15A

STT
TURN
MARKER
B-U/UTIL
SPEC
EMERG
ECE
MOUNT
ELECT
REFLECT
ACCY
MERCH
TECH

## RELATED ACCESSORIES



### Fits 119A/R

amber	119-15A
red	119-15R



### Fits 122A/R, 122XA/XR, 123A/R, 124A/R

amber	124-15A
red	124-15R



### Fits 125A/R

amber	125-15A
red	125-15R



### Fits 126A/C/R

amber	126-25A
clear	126-25C
red	126-25R



### Fits 130A/R

amber	130-25A
red	130-25R



### Fits 35A/R, 135A/R

amber	134-15A	B134-15A	V134-15A
red	134-15R	B134-15R	V134-15R



### Fits 136A/R

amber	136-15A
red	136-15R



### Fits 38A/R, 138A/B/C/G/R & 139A/R

amber	138-15A	B138-15A	V138-15A
blue		B138-15B	
clear		B138-15C	
green		B138-15G	
red	138-15R	B138-15R	V138-15R



### Fits 306A/R & 393C

amber	306-25A
clear	306-25C
red	306-25R



### Fits 308A/R

red	308-15R
black	308-15BLK (cover)



### Fits competitive lamps

amber	310-15A
-------	---------



### Fits 313 & 314MA

amber	313-15A
red	313-15R
black	313-15BLK (cover)

# REPLACEMENT LENSES

# RELATED ACCESSORIES



Fits 334-2		
amber	334-15A	B334-15A
blue	334-15B	B334-15B
red	334-15R	B334-15R



Fits 313A/R, 313RA & 339-2		
amber	338-15A	B338-15A
red	338-15R	B338-15R



Fits 343A	
amber	343-25A



Fits 375, 375S, 376S, 377S & 378S	
clear	375-15C



Fits 380S	
clear	380-25C



Fits 382 & 383	
amber	383-25A
clear	383-25C



Fits 384, 384S, 384-P & 385S	
amber	384-15A
clear	384-15C



Fits 389S	
opaque	389-15C

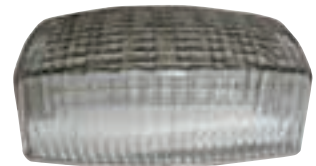

Fits 391C	
clear	391-25



Fits 392C	
clear	392-25C



Fits 413 & 425 series			
amber	410-15A		
blue	410-15B		
red	410-15R	B410-15R	V410-15R
red polycarbonate	410-25R		



Fits 411C/SC	
clear	414-15C

- STT
- TURN
- MARKER
- B-U/UTIL
- SPEC
- EMERG
- ECE
- MOUNT
- ELECT
- REFLECT
- ACCY
- MERCH
- TECH

## RELATED ACCESSORIES



### Fits 413-3 & 425-3

red	415-15R
-----	---------



### Fits 419

amber	419-25A
red	419-25R



### Fits 428 series

red	420-15	V420-15
-----	--------	---------

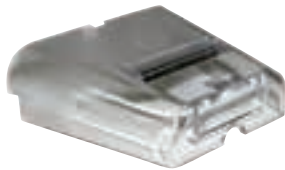

### Fits 436

clear	436-25
-------	--------



### Fits 440/L, 441/L, 444/L, 452/L

red	440-15	V440-15
-----	--------	---------

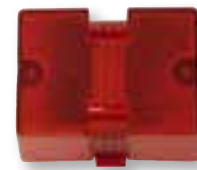

### Fits 444, 444L

red	444-151R
-----	----------



### Fits 445

red/white	445-25
-----------	--------



### Fits 457/L

red	B457-15
red w/ licence light	B457L-15



### Fits 754A & 755A

amber	755-15A
-------	---------



### Fits 756 & 763

amber	756-15A
blue	756-15B
red	756-15R



### Fits 760 & 761

amber	760-25A
clear	760-25C



### Fits 765A/R, 769A/B/C/R & 769MA

amber	769-25A
blue	769-25B
clear	769-25C
red	769-25R



# REPLACEMENT LENSES

# RELATED ACCESSORIES



**Fits 769-1HA & 788**  
 amber 769-25HA



**Fits 771A/B, 773A & 768A/B**  
 amber 771-15A  
 blue 771-15B



**Fits 774A/R**  
 amber 774-15A  
 red 774-15R



**Fits 791**  
 amber 791-25A



**Fits 844**  
 red 844-252



**Fits 844**  
 red 844-253



**Fits 108 & 2549**  
 amber V2549-15A  
 red V2549-15R  
*Fits lights manufactured prior 2019 and newer.*



**Fits 25911**  
 red V25911-25



**Fits 25912**  
 red w/ clear V25912-25



**Fits 25913**  
 red w/ clear V25913-25



**Fits 25914**  
 red w/clear V25914-25



**Fits 25921**  
 red V25921-25



**Fits 25922**  
 red w/clear V25922-25



**Fits 25923**  
 red w/clear V25923-25



**Fits 25924**  
 red w/clear V25924-25

STT
TURN
MARKER
B-U/UTIL
SPEC
EMERG
ECE
MOUNT
ELECT
REFLECT
ACCY
MERCH
TECH



**Peterson offers more than product.  
You get a proven track record of success.**

Peterson's eye-grabbing plan-a-grams are packed with hottest-selling items in safety lighting and accessories. No matter what your store's speciality, they're ready to help you build store traffic—and profits!

But as a Peterson retailer, you get more than just product. No matter which plan-a-gram you choose, you'll benefit from Peterson's reputation for quality and exceptional customer service. It's a reputation we've worked hard to maintain since 1945.

Peterson offers assortments from 2' to 16'. Each one provides an unbeatable assortment of our most popular, quick-turn items for both the self-service and commercial/fleet markets. Better yet, our plan-a-grams' unitized design gives you total flexibility in tailoring your coverage to your customers' needs.

Your local Peterson representative will assist you in customizing your order by providing photos, schematics, corresponding part numbers and quantities for each plan-a-gram unit.



**Ask your Peterson rep about our wide selection of retail plan-a-gram layouts.**

Peterson has exciting new Viz-Pack retail packaging with contemporary "carbon fiber" graphics.

New, thicker, commercial poly bags match this eye-catching look.



# Lighted Retail Displays

Bright displays grab customers' attention



**D24**  
Battery-Operated  
Counter Display  
16" H x 11" W x 6" D

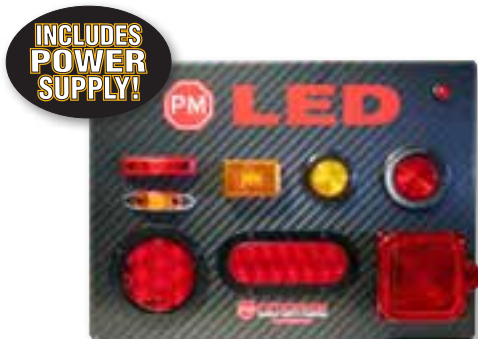

**D10**  
Commercial LED  
Lighted Wall-Mount Display  
15.5" H x 48" W x 3" D



**D17**  
PM LED Lighted  
Wall-Mount Display  
15" H x 21" W x 3" D



**D9**  
LumenX® LED vs  
Incandescent Battery-  
Operated Counter Display  
14.75" H x 8.5" W x 4.5" D



**D28**  
LED Work Light  
Counter Display  
18.75" H x 20" W x 12" D

**D16**  
LED Lighted Wall-Mount  
Display  
23" H x 22" W x 3".25 D  
*Power supply not included.*

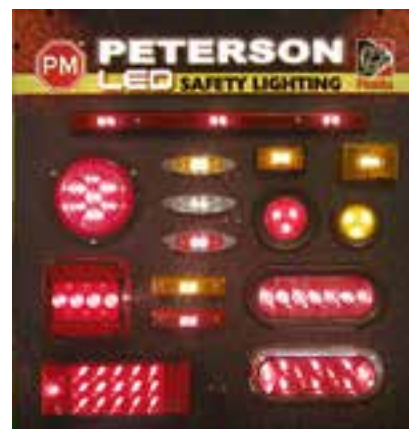

**D31**  
Battery-Operated  
LED Work Light  
Counter Display  
12.5" H x 12.7" W x 9.3" D



**D29**  
PM LED Work Light  
Counter Display  
16" H x 16" W x 9" D

STT
TURN
MARKER
B-U/UTIL
SPEC
EMERG
ECE
MOUNT
ELECT
REFLECT
ACCY
MERCH
TECH

# Header/Fixture Signs

Give your Plan-A-Gram more pulling power

**INCLUDES  
POWER  
SUPPLY!**



**D7**  
Safety Lighting Header  
Same design on both sides  
48" W x 8.25" H



**D27**  
Light-Up Header Sign  
Printed one side only  
48" W x 8.25" H



**D13**  
Double-Sided "Land or Water"  
Safety Lighting Header  
48" W x 8.25" H



**D21**  
Display Banner  
68.5" W x 21.75" H



**D15-RV**  
RV Lighting Header  
24" W x 8.25" H

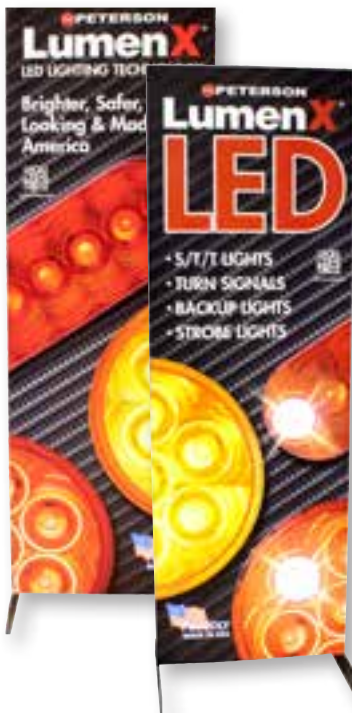

**D25**  
Two-Sided  
Floor Display  
23" W x 72" H



**D21-02**  
Display Banner  
24" W x 16" H



**D11**  
Magnetic Vertical  
Blade Sign (2 per kit)  
5.5" W x 24" H

# Counter Displays & Extras

Round out your merchandising efforts with proven eye-catchers



**PM-CM-0714-Z**  
Full Product Line  
Counter Mat  
16" H x 20" W



**PM-CM-1018-Z**  
12 Volt HD Counter Mat  
16" H x 20" W



**PM-ICM-0919-Z**  
Multi-Volt HD Counter Mat  
16" H x 20" W



**D20-4**  
**D20-6**  
**D20-12**  
Small (4")  
Med (6")  
& Large (12")  
Bin Boxes



**D22-S**  
**D22-M**  
**D22-L**  
Small (7")  
Med (10")  
& Large (21")  
Merchandising  
Baskets

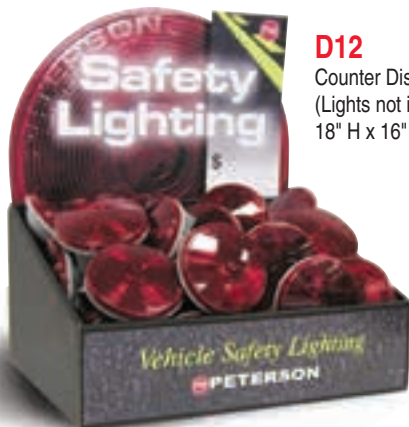

**D12**  
Counter Display Bin  
(Lights not included)  
18" H x 16" W x 12" D

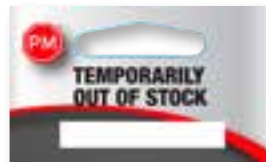

**OV10-72**  
Out of Stock/  
Reorder Card



**D4**  
New Item Tag

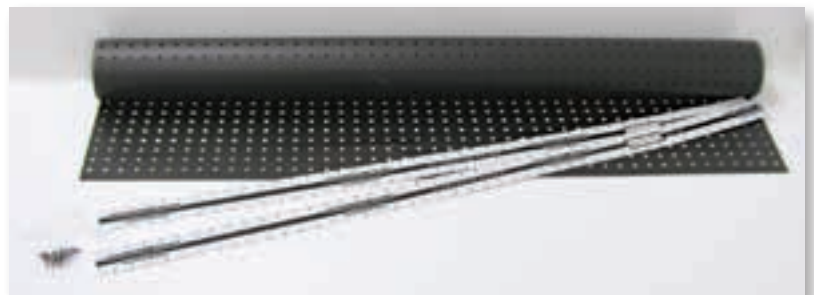

**D3**  
Black  
Plan-A-Gram Kit  
48" x 60"

ST  
TURN  
MARKER  
B-U/UTIL  
SPEC  
EMERG  
ECE  
MOUNT  
ELECT  
REFLECT  
ACCY  
MERCH  
TECH

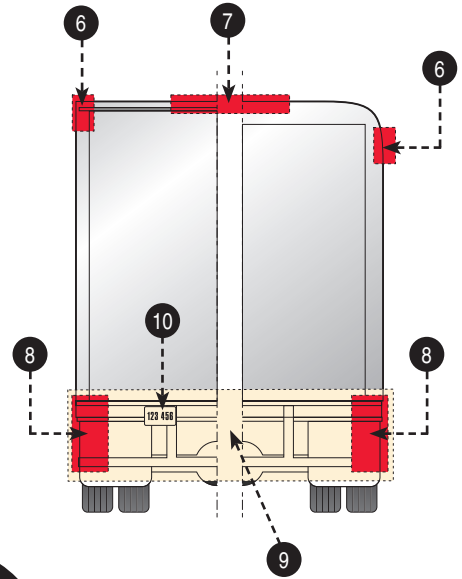
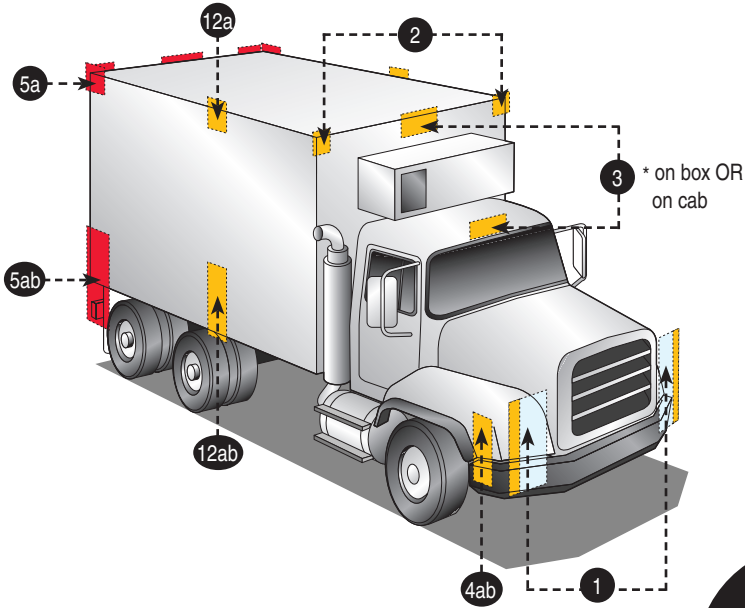

See page 262 for details of numbered areas

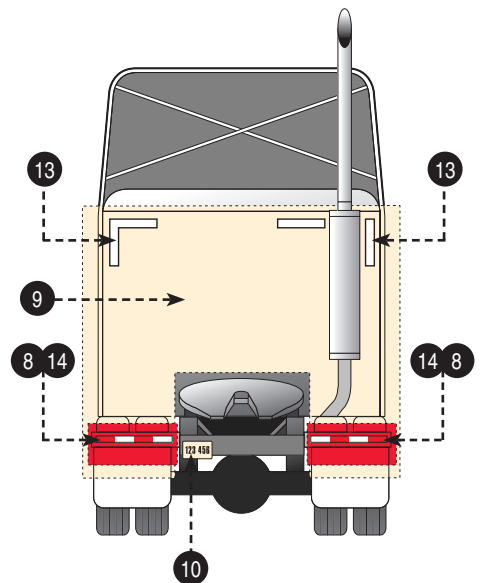
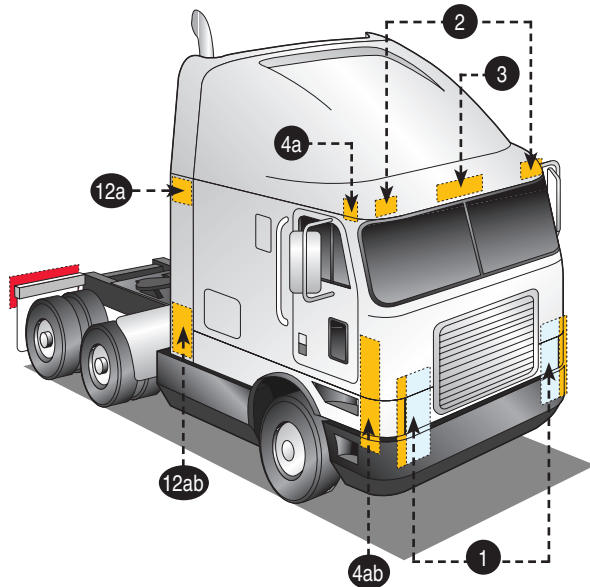
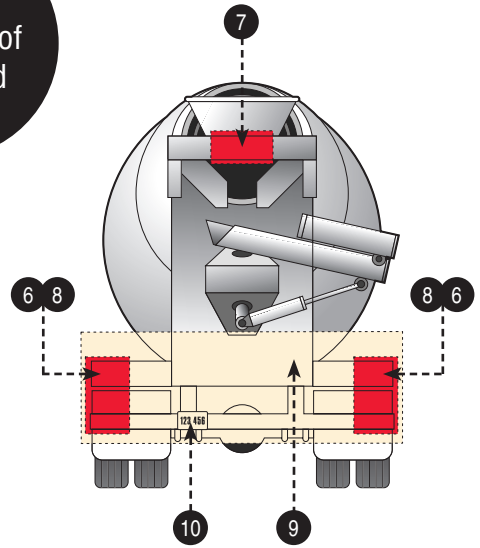
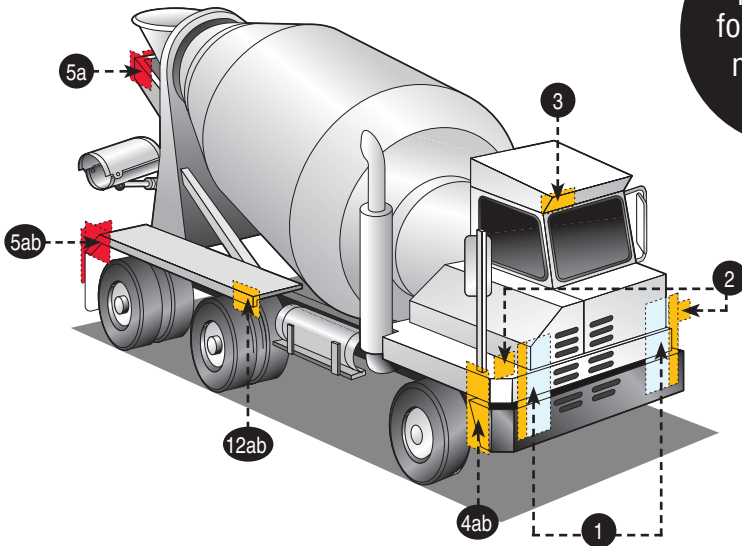

The information provided on pages 192-197 summarizes lighting equipment requirements contained in Federal/Canada Motor Vehicle Safety Standard 108. For complete compliance requirements consult Title 49 - Code of Federal Regulations, Section 571.108 (USA) and Section 108 of the Motor Vehicle Safety Regulations (Canada). State or Provincial regulations, where they may apply, have not been included.

Data and illustrations provided courtesy of NHTSA.



**NHTSA**  
People Saving People  
<http://www.nhtsa.dot.gov>



**Transport Canada**  
<http://www.tc.gc.ca>

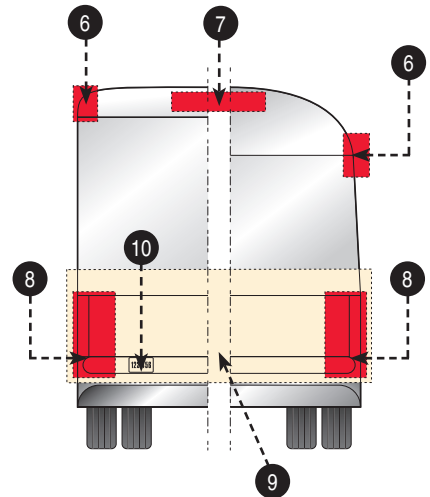
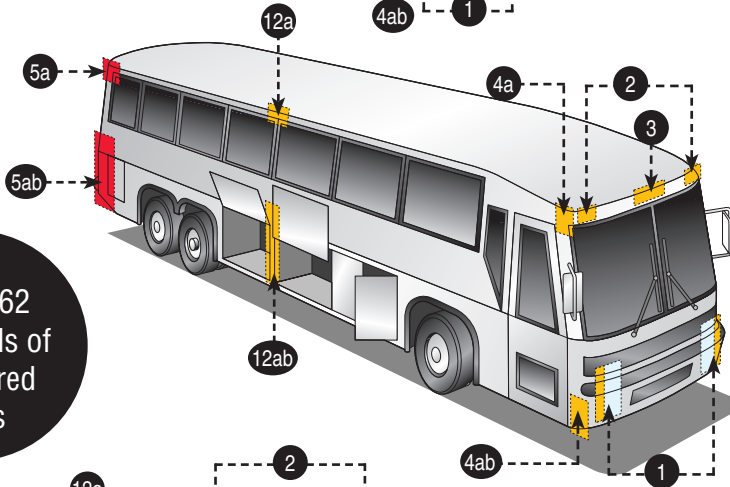
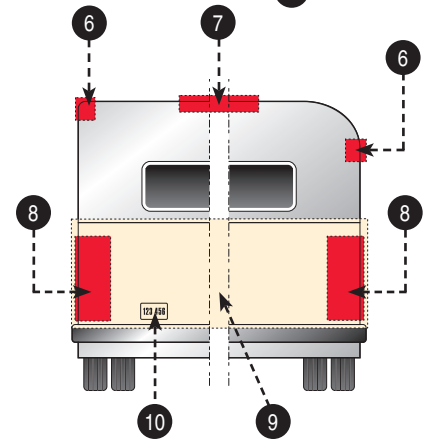
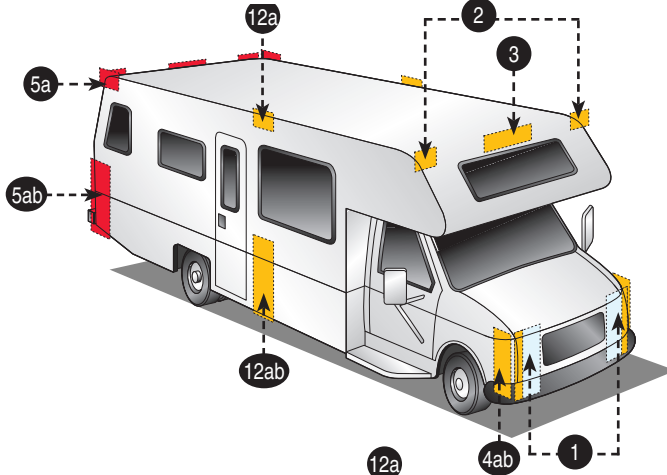
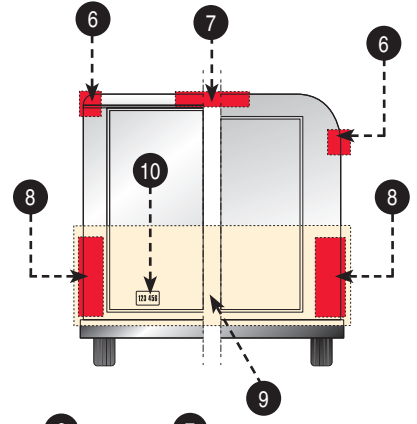
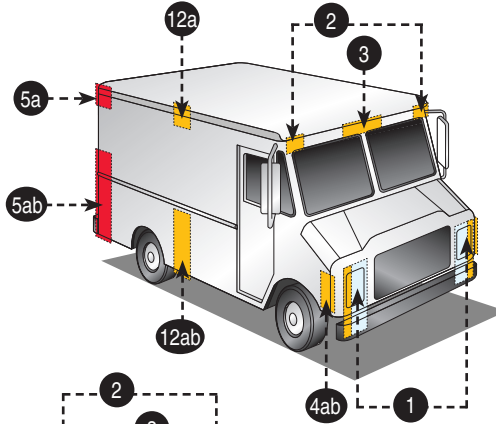

See page 262 for details of numbered areas

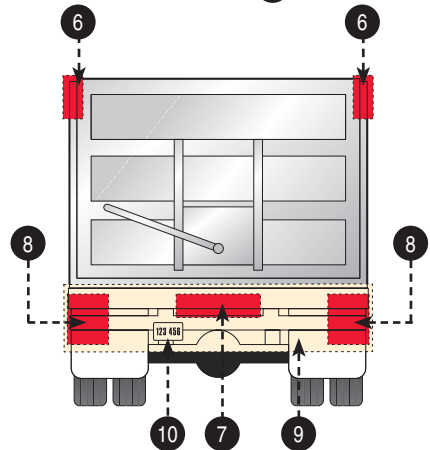
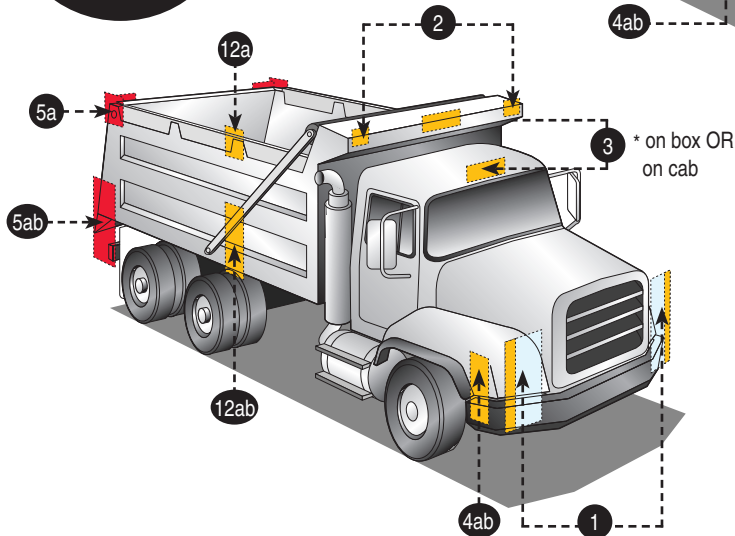

- STT
- TURN
- MARKER
- B-U/UTIL
- SPEC
- EMERG
- ECE
- MOUNT
- ELECT
- REFLECT
- ACCY
- MERCH
- TECH

**IMPORTANT NOTE:** Every lamp, reflex reflector, and conspicuity treatment must be permanently attached in the location specified below and must comply with all applicable requirements prescribed for it by FMVSS/CMVSS 108. The face of any device on the front/rear and sides should be, respectively perpendicular and parallel to the vehicle's centerline, unless it is photometrically certified at installation angle. No part of the vehicle shall prevent any device from meeting its prescribed requirements unless an auxiliary device meeting all prescribed requirements is installed.

**IN CANADA:** Manufacturers and importers of vehicles must have the proper certification test records demonstrating compliance of lighting components with all prescribed requirements.

## BASIC EQUIPMENT REQUIRED ON ALL TRUCKS, BUSES & MPVs

DESCRIPTION				MANDATORY REQUIREMENTS			
Area	Equipment	SAE Lens Coding	Functional Purpose	Quantity	Color	Location	Height mm(in.) from the ground
1	Headlamps - Lower Beam US requires "DOT" lettering on lens US & Canada - light source code required on lens	(H, HR)	Forward road illumination	Minimum 2	White	On the front - symmetrical as far apart as practicable If 4 lamp system - outboard or above upper beams	560-1370 (22-54)
	Headlamps - Upper Beam US requires "DOT" lettering on lens US & Canada - light source code required on lens	(H, HR)	Forward road illumination	Minimum 2	White	On the front - symmetrical If 4 lamp system - inboard or below lower beams	560-1370 (22-54)
	Parking Lamps Vehicles less than 2032mm wide	(P)	Indicate parked vehicle	Minimum 2	White or Yellow	On the front - symmetrical as far apart as practicable	380-1530 (15-60)
	Daytime Running Lamps (DRL) Canada - required / US - option US requires "DRL" lettering on lens if not headlamp	(Y2)	Indicate in use vehicle	Minimum 2	White or Yellow	On the front - symmetrical as far apart as practicable	380 (15) min. Max. depends on type of DRL
	Front Turn Signal/ Hazard Warning Lamps	(I)	Indicate direction of turn/ identify disabled vehicle	Minimum 2	Yellow	On the front - symmetrical as far apart as practicable	380-2110 (15-83)
2	Front Clearance Lamps Vehicles 2032mm wide or wider *photometrically certified at installation angle	(P2, PC* or P3, PC2*)	Show vehicle's width	Minimum 2	Yellow	At widest point - symmetrical on the front or near the front facing forward	As high as practicable
3	Front Identification Lamps (ID) Vehicles 2032mm wide or wider	(P2 or P3)	Indicate presence of a wide vehicle	Exactly 3	Yellow	On the front - center horizontally spaced 150 mm (6 in.) to 300 mm (12 in.) apart	As high as practicable or on top of the cab
4	a Front Side Marker Lamps *photometrically certified at installation angle	(P2, PC* P3, PC2*)	Front and rear side marker lamps / side reflex reflector indicate vehicle's presence and length	Minimum 2	Yellow	Each side at front as far forward as practicable	380 (15) minimum
	b Front Side Reflex Reflectors	(A)		Minimum 2	Yellow	At front - symmetrical as far forward as practicable facing sideward	380-1530 (15-60)
5	a Rear Side Marker Lamps ** *photometrically certified at installation angle	(P2, PC* or P3, PC2*)	Rear and rear side marker lamps / side reflex reflector indicate vehicle's presence and length	Minimum 2	Red	Each side at rear as far back as practicable	380 (15) minimum
	b Rear Side Reflex Reflectors ** **not required on Truck Tractors	(A)		Minimum 2	Red	Each side at rear as far back as practicable facing sideward	380-1530 (15-60)
6	Rear Clearance Lamps Vehicles 2032mm wide or wider Not required on Truck Tractors *photometrically certified at installation angle	(P2, PC* or P3, PC2*)	Show vehicle's width MAY NOT be combined with tail lamps	Minimum 2	Red	At widest point - symmetrical on the rear or near the rear facing rearward	As high as practicable may be lower only if rear ID lamps are at the top
7	Rear Identification (ID) Lamps Vehicles 2032mm wide or wider Not required on Truck Tractors	(P2 or P3)	Indicate presence of a wide vehicle	Exactly 3	Red	On the rear - center horizontally spaced 150mm (6 in.) to 300mm (12 in.) apart facing rearward	<b>In Canada:</b> at the top - lower if door header narrower than 25mm <b>In USA:</b> as high as practicable
8	Tail Lamps	(T)	Indicate vehicle's presence and width	Minimum 2	Red	On the rear - symmetrical as far apart as practicable	380-1830 (15-72)
	Stop Lamps	(S)	Indicate braking	Minimum 2	Red	On the rear - symmetrical as far apart as practicable	380-1830 (15-72)
	Rear Turn Signal/ Hazard Warning Lamps	(I)	Indicate direction of turn/ identify disabled vehicle	Minimum 2	Red or yellow	On the rear - symmetrical as far apart as practicable	380-2110 (15-83)
	Rear Reflex Reflectors	(A)	Show vehicle's presence and width	Minimum 2	Red	On the rear - symmetrical as far apart as practicable	380-1530 (15-60)
9	Backup Lamp	(R)	Illuminates ground behind the vehicle and alert road users	Minimum 1	White	Rear	No requirement
10	License Plate Lamp(s)	(L)	Illuminates license plate	Minimum 1	White	On the rear - above or at the sides of license plate	No requirement
11	Center High Mounted Stop Lamp Vehicles less than 2032mm wide and 4536kg	(U3)	Indicates braking	1	Red	On the rear - centerline of the vehicle	860 (34) minimum

## ADDITIONAL EQUIPMENT FOR SPECIFIC VEHICLES VEHICLES 9.1m (30 ft.) LONG OR LONGER

DESCRIPTION				MANDATORY REQUIREMENTS			
Area	Equipment	SAE Lens Coding	Functional Purpose	Quantity	Color	Location	Height mm(in.) from the ground
12	a Intermediate Side Marker Lamps	(P2 or P3)	Indicate presence of a long vehicle	Minimum 2	Yellow	Each side near center	380 (15) minimum
	b Intermediate Side Reflex Reflectors	(A)	Indicate presence of a long vehicle	Minimum 2	Yellow	Each side near center facing sideward	380-1530 (15-60)

### Truck Tractors

DESCRIPTION		MANDATORY REQUIREMENTS					
Area	Conspicuity Treatment	DOT Coding	Quantity	Color	Location	Height	Options
13	Rear Upper Body Markings	DOT-C DOT-C2	Exactly 2 pairs of 300mm long strips	White	Rear upper corners of cab facing rearward	As high as practicable excluding fairings	
14	Rear Marking	DOT-C3 DOT-C4	Exactly 2 sections of min. 600mm each	Red/ White	Rear - facing rearward - on fenders, on mud flap brackets, or within 300mm below the top of mud flaps	As horizontal as practicable and not higher than 1525mm from the ground	If mud flaps not used - on the cab or frame mounted brackets



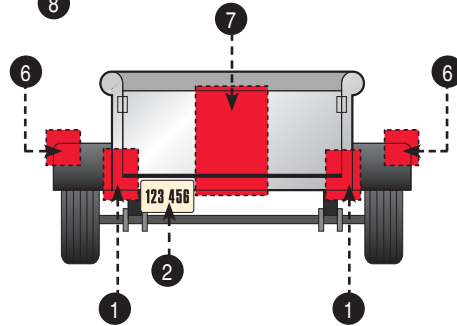
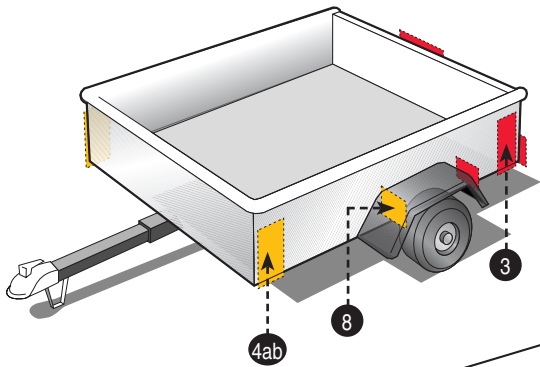
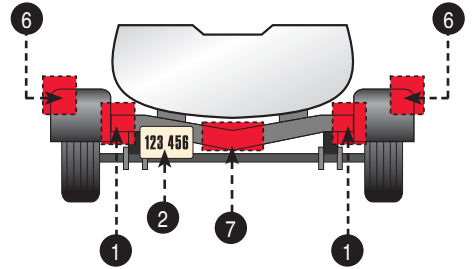
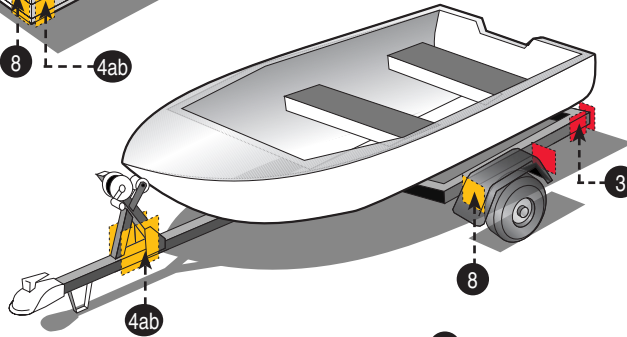
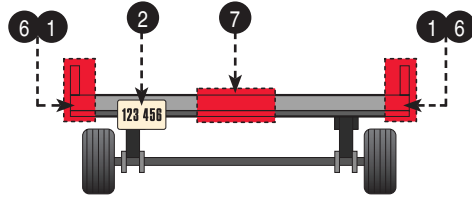
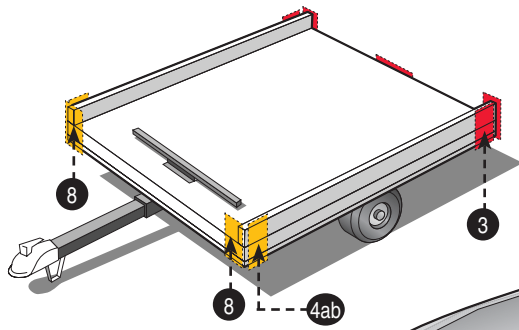

See page 265 for details of numbered areas

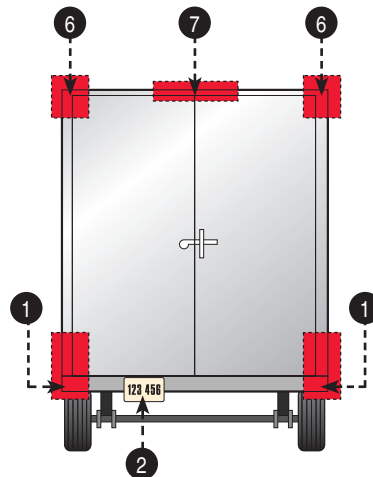
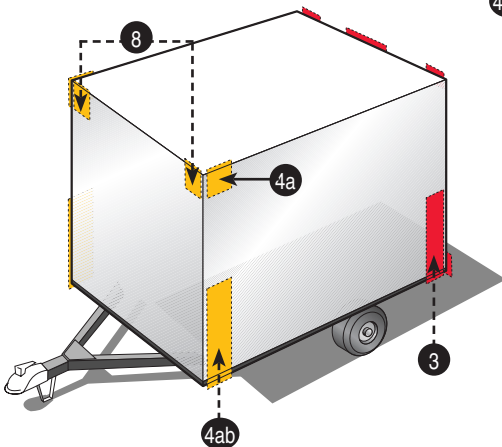
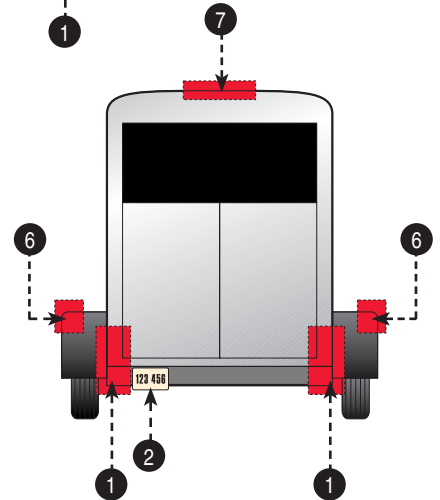
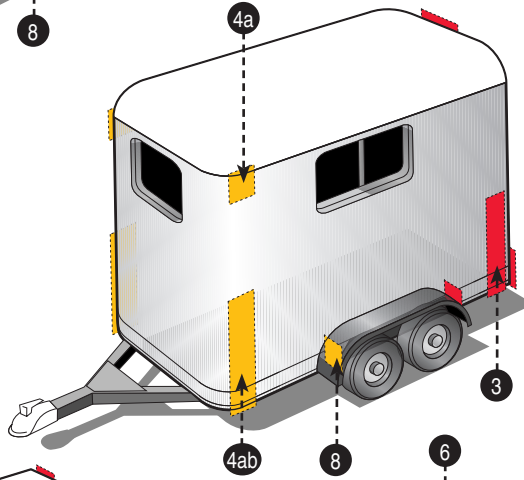

STT
TURN
MARKER
B-U/UTIL
SPEC
EMERG
ECE
MOUNT
ELECT
REFLECT
ACCY
MERCH
TECH

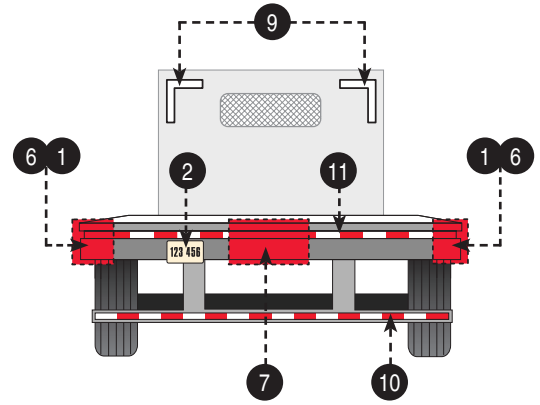
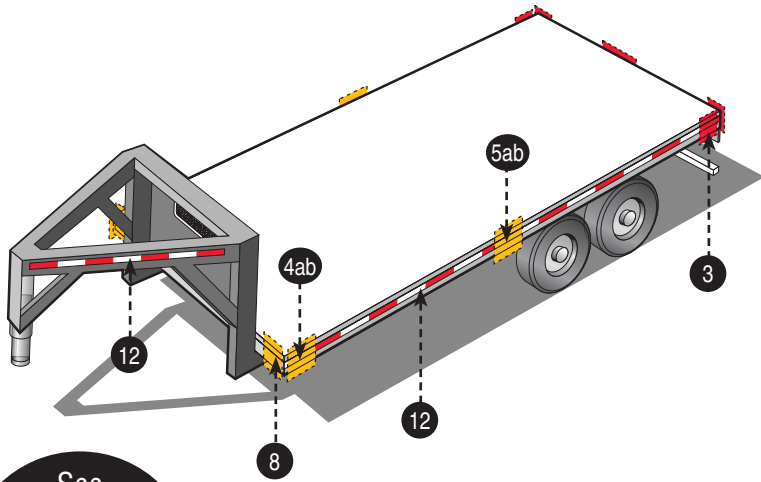

See page 265 for details of numbered areas

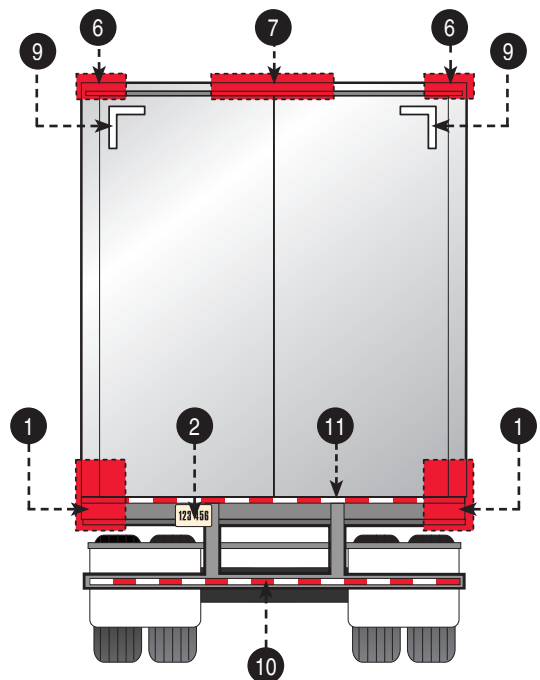
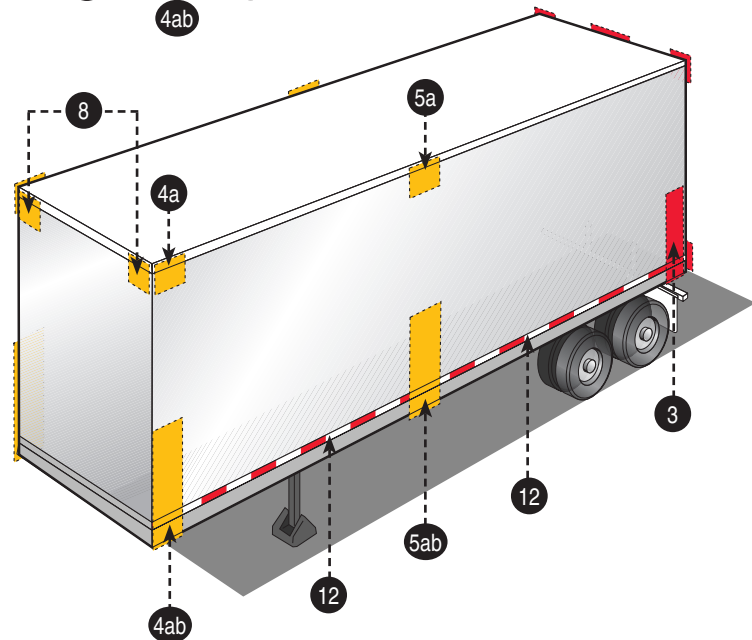
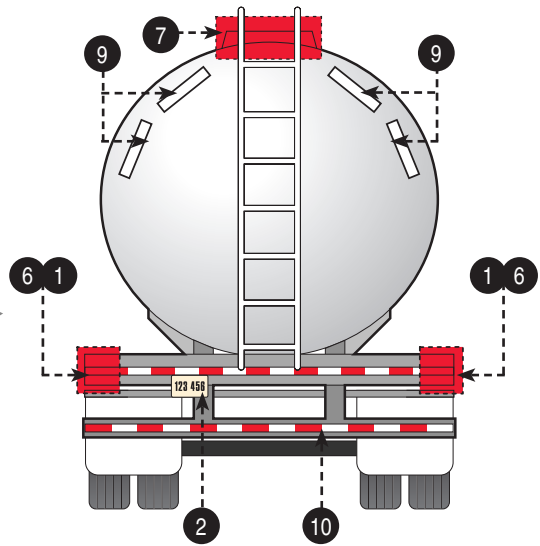
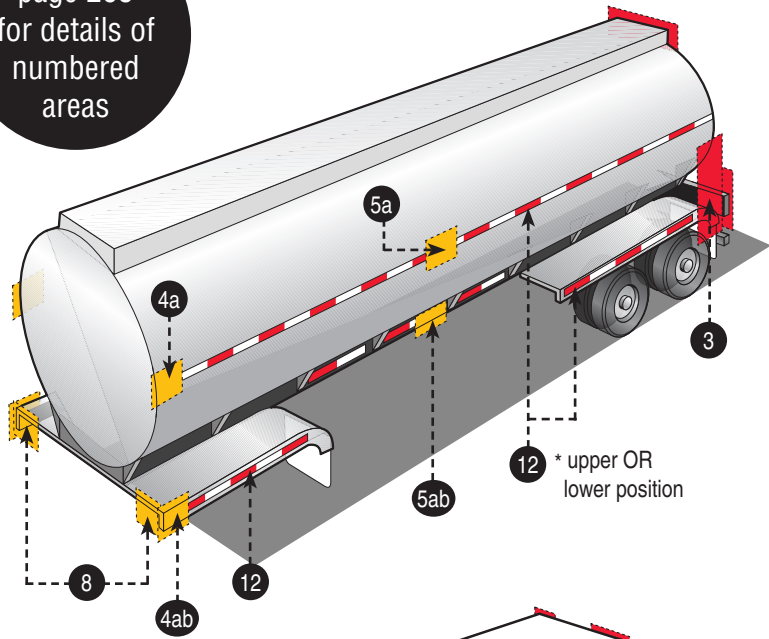

**IMPORTANT NOTE:** Every lamp, reflex reflector, and conspicuity treatment must be permanently attached in the location specified below and must comply with all applicable requirements prescribed for it by FMVSS/CMVSS 108. The face of any device on the front/rear and sides should be, respectively perpendicular and parallel to the vehicle's centerline, unless it is photometrically certified at installation angle. No part of the vehicle shall prevent any device from meeting its prescribed requirements unless an auxiliary device meeting all prescribed requirements is installed.

**IN CANADA:** Manufacturers and importers of vehicles must have the proper certification test records demonstrating compliance of lighting components with all prescribed requirements.

## BASIC EQUIPMENT REQUIRED ON ALL TRAILERS

DESCRIPTION				MANDATORY REQUIREMENTS			
Area	Equipment	SAE Lens Coding	Functional Purpose	Quantity	Color	Location	Height mm(in.) from the ground
1	Tail Lamps	(T)	Indicate vehicle's presence and width	Minimum 2	Red	On the rear - symmetrical as far apart as practicable	380-1830 (15-72)
	Stop Lamps	(S)	Indicate braking	Minimum 2	Red	On the rear - symmetrical as far apart as practicable	380-1830 (15-72)
	Rear Turn Signal Lamps	(I)	Indicate direction of turn	Minimum 2	Red or Yellow	On the rear - symmetrical as far apart as practicable	380-2110 (15-83)
	Rear Reflex Reflectors	(A)	Indicate vehicle's presence and width	Minimum 2	Red	On the rear - symmetrical as far apart as practicable facing rearward	380-1530 (15-60)
2	License Plate Lamp(s)	(L)	Illuminates license plate	Minimum 1	White	On the rear - above or at the sides of license plate	No requirement
3	Rear Side Marker Lamps <small>*photometrically certified at installation angle</small>	(P2, PC* or P3, PC2*)	Front and rear side marker lamps / side reflex reflectors indicate vehicle's presence and length	Minimum 2	Red	Each side at rear as far back as practicable under 2032mm (80") wide	380-1530 (15-60) no max. for veh.
	Rear Side Reflex Reflectors	(A)		Minimum 2	Red	Each side at rear as far back as practicable	380-1530 (15-60) facing sideward
4	a) Front Side Marker Lamps <small>*photometrically certified at installation angle</small>	(P2, PC* or P3, PC2*)	Front and rear side marker lamps / side reflex reflectors indicate vehicle's presence and length	Minimum 2	Yellow	Each side at front as far forward as practicable	380 (15) minimum
	b) Front Side Reflex Reflectors	(A)		Minimum 2	Yellow	Each side at front as far forward as practicable facing sideward	380-1530 (15-60)

† not required on trailers shorter than 6 feet in length

## ADDITIONAL EQUIPMENT FOR TRAILERS EXCEEDING THE FOLLOWING PARAMETERS

Length 9.1m (30 ft.) or longer

DESCRIPTION				MANDATORY REQUIREMENTS			
Area	Equipment	SAE Lens Coding	Functional Purpose	Quantity	Color	Location	Height mm(in.) from the ground
5	a) Intermediate Side Marker Lamps	(P2 or P3)	Indicate presence of a long vehicle	Minimum 2	Yellow	Each side near center facing sideward	380 (15) minimum
	b) Intermediate Side Reflex Reflectors	(A)	Indicate presence of a long vehicle	Minimum 2	Yellow	Each side near center facing sideward	380-1530 (15-60)

Width 2032mm (80 in.) or wider

DESCRIPTION			MANDATORY REQUIREMENTS				
Area	Equipment	SAE Lens Coding	Functional Purpose	Quantity	Color	Location	Height
6	Rear Clearance Lamps <small>*photometrically certified at installation angle</small>	(P2, PC* or P3, PC2*)	Show vehicle's width <b>MAY NOT</b> be combined with tail lamps	Minimum 2	Red	At widest point - symmetrical on the rear or near the rear facing rearward	As high as practicable may be lower only if ID lamps are at the top
7	Rear Identification (ID) Lamps	(P2 or P3)	Indicate presence of a wide vehicle	Exactly 3	Red	On the rear - center horizontally spaced 150mm (6 in.) to 300mm (12 in.) apart facing rearward	<b>In Canada:</b> at the top - may be lower if door header narrower than 25mm <b>In USA:</b> as high as practicable
8	Front Clearance Lamps <small>*photometrically certified at installation angle</small>	(P2, PC* or P3, PC2*)	Show vehicle's width	Minimum 2	Yellow	At widest point - symmetrical on the front or near the front facing forward	As high as practicable

Width 2032mm (80 in.) or wider **AND** GVWR 4536 kg (10,000 lb.) or more

DESCRIPTION		MANDATORY REQUIREMENTS					
Area	Conspicuity Treatment	DOT Coding	Quantity	Color	Location	Height	Options
9	Rear Upper Body Markings	DOT-C DOT-C2 DOT-C3 DOT-C4	Exactly 2 pairs of 300mm long strips	White	On the rear upper corners facing rearward	At the top	Reflex reflectors may not be required if they are replaced in their required location with conspicuity treatment.
10	Bumper Bar Marking		Continuous	Red/White	On the rear bumper bar's horizontal element full width - facing rearward	No requirement	
11	Rear Lower Body Marking		Continuous	Red/White (see options)	On the rear full width of the vehicle facing rearward	As horizontal as practicable and as close as practicable to the range of 375 to 1525mm from the ground	<b>Optional in Canada:</b> Rear lower body and side conspicuity treatment may also be solid white, solid yellow, or white and yellow.
12	Side Marking		(see location)	Red/White (see options)	Each side - facing sideward continuous, or evenly spaced over minimum of 50% of length starts and ends as close to the front and rear of the vehicle as practicable	As horizontal as practicable and as close as practicable to the range of 375 to 1525mm from the ground	

STT  
TURN  
MARKER  
B-U/UTIL  
SPEC  
EMERG  
ECE  
MOUNT  
ELECT  
REFLECT  
ACCY  
MERCH  
TECH

## AUTO SELECT™

Auto Select is Peterson's trademark name for a selected group of imported automotive products. Unlike other imported products, Auto Select are designed, built and quality-inspected to PM's stringent standards.

## ASAE

American Society of Agricultural Engineers. Defines industry standards for agricultural equipment, including ASAE S279.17, Lighting & Marking of Agricultural Equipment on Highways.

## BLADELIGHTS®

Peterson's trademark name for snowplow and emergency lights.

BEACON See WARNING BEACON

## BULBS

A glass capsule containing electrodes or a filament which glows when connected to an electrical source. Three bulb types are generally used for illumination and vehicle safety lighting:

- Incandescent—there are two basic incandescent bulb styles most frequently used in general lighting products.
- Bayonet Base—a traditional, widely used metal-based bulb such as 1156, 1157 or 1895.
- Wedge Base—a non-indexed, baseless, all-glass bulb such as 3056, 3157 or 193.
- An incandescent bulb is rated by the number of hours it will burn under ideal laboratory conditions. Peterson uses 15,000 hour-rated bulbs whenever possible to achieve maximum performance.
- Halogen—commonly known for bright, intense light from a small package. In halogen bulbs, tungsten particles from the filament are continually redeposited back on the filament to extend its life. Halogens are available in H1, H3 bulb and sealed beam configurations.
- Xenon—a bulb type commonly used in emergency warning lights. Xenon refers to the gas sealed inside the bulb. It serves as a starter in order to accelerate the start up process of high-intensity discharge headlights.

See also: LED, WARNING BEACON

## CANDELA

A standard unit measuring the amount of visible light emitted by a light source in one direction.

## CANDELA-SECOND

A standard unit measuring the amount of light seen through a clear lens during one second.

## DOT

US Department of Transportation; a cabinet-level Federal department which governs transportation systems in the United States.

See also: FMVSS 108, NHTSA

## DRIVING LIGHT

A front-mounted white light which produces a long-range, pencil-shaped light pattern. Greatly increases nighttime visibility at highway speeds. See illustration of fog and driving light beam patterns on page 271.

See also: FOG LIGHT

EMERGENCY BEACON See WARNING BEACON

## FMVSS 108

Federal Motor Vehicle Safety Standard No. 108; Part of the Department of Transportation's uniform safety standards for new vehicles and vehicle components. FMVSS 108 regulates head lamps, tail lamps, stop lamps, reflectors, marker lamps, turn signals, ID lamps, etc. Peterson products exceed this regulation.

See also: DOT, NHTSA

## FOG LIGHT

A front-mounted lamp which produces a low, wide beam pattern in front of the vehicle to greatly increase short-range visibility. Ideal for added driving safety in rain, snow or fog. See illustration of fog and driving light beam patterns on page 271.

See also: DRIVING LIGHT

## FRESNEL LENS

A compound-angle refracting lens divided into prismatic sections. Designed to collect light and concentrate output in a specific direction.

See also: LENS

## GREAT WHITE®

Peterson's trademark name for our white light-emitting diodes.

See also: LED

GROMMET See MOUNTING CONFIGURATIONS

HALOGEN See BULBS

## HARDWIRED

A term for permanently attaching lead wires to a lamp assembly, rather than using a detachable terminal plug. Hardwired lamps are better sealed and have fewer connection points for greater durability and better corrosion resistance.

INCANDESCENT See BULBS

## LED (LIGHT EMITTING DIODE)

A small, solid-state, electronic light source. Some of the advantages of LED-based lamps are:

- up to 100,000-hour rated life
- Solid state—Vibration resistant, with no filament to break
- Low amp draw—90% less than standard bulbs
- Faster response time for added safety
- Maintenance free

## LENS

A transparent or translucent cover over a bulb or LED. In accordance with FMVSS 108, Peterson manufactures lenses with two thermal plastic resins:

- Acrylic—the most widely used material for lenses. Features moderate heat and impact-resistance.
- Polycarbonate—a premium material with higher impact and heat resistance than acrylic.

See also: FMVSS 108, FRESNEL LENS

## LUMEN

A standard unit measuring the flux emitted by a light source in a solid angle of 1 steradian by a point source having a uniform intensity of 1 candela. *Measured lumens* is the flux emitted by a complete lighting assembly as observed in a lab. *Calculated lumens* for an LED light assembly is derived by multiplying the flux of a single diode by the total number of diodes contained in the assembly.

## LUMINOUS FLUX

The perceived power or visual intensity of a light source.

## JOULE

A standard unit measuring energy generated by an electrical circuit. For a strobe circuit, the figure may refer to the energy of a single flash or to a succession of rapid flashes.

See also: WARNING BEACON

## MAXI-SEAL®

Peterson's trademark name for our custom wire harness systems specifically designed for medium- and heavy-duty trucking industry, and our electrical accessory program for the aftermarket.

## MIRRORS

Peterson offers a complete line of passenger car, light truck and van, and heavy duty mirrors and assemblies.

- **Convex**—also known as "blind spot" mirrors. Features a fish-eye design permitting a wider view angle than a traditional mirror.
- **Elliptical**—features a protruding, half-moon shape that allows driver to view a 180° area with a minimum of distortion.
- **Wedge Base Convex**—an improved version of the traditional convex. Allows over 50° increase in viewing area with less distortion.
- **West Coast**—A style of rear-view mirror assembly designed for large trucks characterized by a tall, narrow mirror face and two or three mounting arms that attach to the door above and below the window opening.

## MOUNTING CONFIGURATIONS

Peterson offers many mounting options for our vehicle lights. The three most common are:

- **Flush mount**—a metal or rigid plastic bracket locates the light behind or within a pre-cut mounting hole so that the light does not protrude appreciably beyond the mounting surface.
- **Grommet mount**—a rubber or flexible plastic collar push-fits between the light assembly and a pre-cut mounting hole of specific size and shape. Provides some degree of vibration isolation. Often allows lamp removal without tools.
- **Surface mount**—light is attached above the surface of the vehicle. Usually prevents the need for creating large holes in the material, but small holes may be required for routing wires and attachment hardware such as screws, bolts, or rivets. Light assembly may mount directly to the vehicle, or may use a separate mounting bracket.

## NHTSA

National Highway Transportation Safety Administration; A part of the Department of Transportation, this Federal agency oversees and regulates many aspects of vehicle construction and highway travel.

See also: DOT, FMVSS 108

## NIGHTWATCHER®

Nightwatcher® is Peterson's trademark name for the entire line of high quality fog and driving lights, off-road lights including LED bar light retail series, and related accessories.

## PAR 36

An industry standard size and shape for directional sealed beams. Does not designate voltage, brightness or beam pattern.

## PHOTOMETRIC

Photometry is the calculation and measurement of quantities of light, such as luminous intensity. This is usually measured in candela or candle power.

## PIRANHA®

Peterson's trademark name for our premium LED lights with a higher number of diodes for a distinctive multi-diode lens look. Piranha® lights not only use state-of-the-art LED circuitry, but are designed and manufactured to be unsurpassed in optical performance and durability while exceeding all applicable regulations and standards.

## REFLEX

The characteristic of efficiently reflecting light directly back towards its source regardless of the source's location. Also, a surface or component having this characteristic.

## SAE

Society of Automotive Engineers; A non-governmental body which establishes standards for the automotive industry.

## SPITFIRE®

Peterson's trademark name for our exclusive microprismatic, wide angle reflectors. 47,000 microprisms per square inch provide superior candle power compared to conventional reflectors.

**STROBE** See WARNING BEACON

## SUBMERSIBLE

A submersible light allows water into the unit when submerged. The bulb and socket are protected by an air pocket formed by the belljar principle which permits only a certain amount of water to enter by capturing a pocket of air within the lens assembly, preventing water from contacting the bulb.

**VIBAR®** and **VIBAR II®** (VIBRATION IMPACT BARRIER)

Developed in the 1960's, Peterson's Vibar® was the first real shock-mounted socket in the industry and eventually became the standard. This exclusive, resilient socket absorbs road shock and vibration for longer bulb life.

## WARNING BEACON

There are three basic types of warning beacons:

- **Flashing**—an emergency lamp which provides intermittent power to a stationary bulb, causing it to flash or blink on and off.
- **Revolving**—revolving lights are available in several variations:
  - **2-Beam**—an emergency lamp with two sealed beams or light bulbs which rotate to produce a full, 360° warning.
  - **4-Beam**—an emergency lamp with four bulbs. Compared to a similar 2-beam unit, produces twice the light output and twice as many flashes for a given rotation speed.
  - **Rotating Reflector**—features a stationary light source with a revolving reflector to produce the 360° warning. This design is commonly used in light bars and compact units.
- **Strobe**—lamp which energizes a gas-filled glass tube to produce, quick, extremely bright flashes.
- **Dual Flash/Quad Flash**—a unit which flashes one strobe light head several times in quick succession before a longer pause. If the system is equipped with multiple strobe heads, each head flashes multiple times in turn.
- **Master/Slave Units**—the master unit has a built-in control circuit, will operate independently by itself and can operate a slave unit. The slave unit has no built-in control circuit and requires the master unit to operate.

See also: CANDELA-SECOND, JOULE, WATT-SECOND

## WATT-SECOND

A standard unit measuring the amount of the electrical current delivered per second.

## WELDING

Fusing plastic components together by quickly generating friction heat to momentarily melt the mating surface and create a strong, hermetically-sealed bond. Peterson uses three distinct plastic welding techniques:

- **Linear**—vibrating one part against another in a single direction.
- **Sonic**—subjecting the assembly to high-frequency sound waves which vibrate the seams of the plastic.
- **Spin**—rotating one component against another at high speed to create a circular bonding surface

**XENON** See BULBS

## VIZ PACK

Peterson's term for a variety of retail-friendly, transparent package designs, including clamshells, blister packs, and bags. All Viz Packs are clearly labeled with part number and description, are pilfer-resistant and tamper-evident, and nearly all are hangable.

STT
TURN
MARKER
B-U/UTIL
SPEC
EMERG
ECE
MOUNT
ELECT
REFLECT
ACCY
MERCH
TECH

## SAE LIGHTING IDENTIFICATION CODES & STANDARDS

- A Reflex reflectors
- A2 Wide angle reflex reflectors
- C Motorcycle auxiliary front lamps
- D Motorcycle and motor-driven cycle turn signal lamps
- E Side turn signal lamps—vehicles 12 m or more in length
- E2 Side turn signal lamps—vehicles less than 12 m in length
- F Front fog lamps
- F2 Fog tail lamps
- G Truck cargo lamps
- H Sealed beam headlamps
- HG Discharge forward lighting headlamps
- HH Sealed beam headlamp housings
- HR Replaceable bulb headlamps
  - I Turn signal lamps
- I3 Turn signal lamps spaced from 75 mm to less than 100 mm from headlamp
- I4 Turn signal lamps spaced from 60 mm to less than 75 mm from headlamp
- I5 Turn signal lamps spaced less than 60 mm from headlamp
- I6 Rear mounted turn signal lamps and front mounted turn signal lamps mounted 100 mm or more from the headlamp, for use on vehicles 2032 mm or more in overall width
- I7 Front mounted turn signal lamps mounted less than 100 mm from the headlamp, for use on vehicles 2032 mm or more in overall width
- K Front cornering lamps
- K2 Rear cornering lamps
- L License plate lamps
- M Motorcycle and motor-driven cycle headlamps—motorcycle type
- N Motorcycle and motor-driven cycle headlamps—motor-driven cycle type
- O Spot lamps
- P Parking lamps
- P2 Clearance, side marker and identification lamps
- P3 Clearance, side marker and identification lamps for use on vehicles 2032 mm or more in overall width
- PC Combination clearance and side marker lamps
- PC2 Combination clearance and side marker lamps for vehicles 2032 mm or more in overall width
- Q Turn signal operating units—Class A

- QB Turn signal operating units—Class B
  - QC Vehicular hazard warning signal operating unit
  - R Backup lamps
  - S Stop lamps
  - S2 Stop lamps for use on vehicles 2032 mm or more in overall width
  - T Tail lamps (rear position lamps)
  - T2 Tail lamps (rear position lamps) for use on vehicles 2032 mm or more in overall width
  - U Supplemental high-mounted stop and turn lamps
  - U2 Supplemental high-mounted stop and turn lamps for use on vehicles 2032 mm or more in overall width
  - U3 Center high-mounted stop lamps for passenger cars, light trucks and MPVs
  - W Warning lamps for emergency, maintenance and service vehicles
  - W2 Warning lamps for school buses
  - W3 360-degree emergency warning lamps
  - W4 Emergency warning devices
  - W5-1 360-degree gaseous discharge lamps—Class 1
  - W5-2 360-degree gaseous discharge lamps—Class 2
  - W5-3 360-degree gaseous discharge lamps—Class 3
  - Y Driving lamps
  - Y2 Daytime running lamps
  - Z Auxiliary low beam lamps
- 
- J590 Turn signal flashers
  - J595 Directional Flashing Optical Warning Devices for Authorized Emergency, Maintenance, and Service Vehicles
  - J845 Omnidirectional Optical Warning Devices for Authorized Emergency, Maintenance, and Service Vehicles
  - J914 Side Turn Signal Lamps for Vehicles Less than 12 m in Length
  - J945 Vehicular Hazard Warning Flashers - Canceled July 1999
  - J1054 Warning Lamp Alternating Flashers
  - J1318 Gaseous Discharge Warning Lamp For Authorized Emergency, Maintenance, And Service Vehicles
  - J1690 Vehicular Hazard Warning Flashers
  - J2039 Side Turn Signal Lamps for Vehicles 12 m or More in Length

## SAE PC RATING EXPLAINED

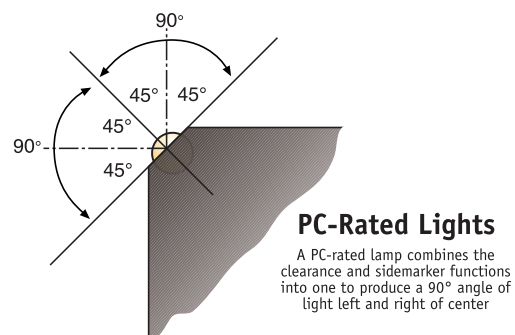
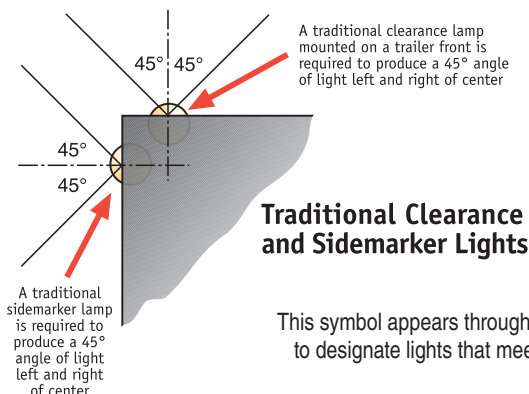

## SAE CLASS RATINGS – BACK-UP ALARMS

Class	Sound Level	The Society of Automotive Engineers (SAE) has developed performance standards for electric back-up alarms that are intended for use on heavy construction machinery. This chart shows the decibel level established for each of six classes defined in SAE Standard J944. The sound level tolerance for each class is +/- 4 dB(A). Alarms conforming to SAE J944 must also meet additional criteria relating to sound frequency, temperature range and resistance to rain, vibration and corrosion.
A	112 dB(A)	
B	107 dB(A)	
C	97 dB(A)	
D	87 dB(A)	
E	77 dB(A)	
F	Other	

## SAE CLASS RATINGS – STROBES

Class	Intended Function	The Society of Automotive Engineers (SAE) has developed performance standards for strobe/warning lights. This chart shows the three classes defined in various SAE standards and their intended use. Each class is defined by specific photometric criteria for flash brightness and distribution that are too complex and numerous to be listed here. Strobes conforming to SAE standards must also meet additional criteria relating to housing durability, temperature range and resistance to rain, vibration and corrosion.
1	Emergency Response	
2	Warning	
3	Identification	

## RECOMMENDED WIRE GAUGES

American Wire Gauge (AWG) is the standard measurement of wire sizes in the US. The higher the gauge number, the thinner the conductor.

Heavier gauge wire is required as either amperage or wire length increases. Overloaded wiring can negatively affect reliability and safety due to excessive voltage drop and heat. Wires thinner than 18 AWG are not recommended for vehicular use.

### Wire Gauge Specification

Gauge (AWG)	Diameter (inch)	Diameter (mm)	Cross Section (mm <sup>2</sup> )
0000	0.46	11.68	107.16
000	0.4096	10.40	84.97
00	0.3648	9.27	67.40
0	0.3249	8.25	53.46
1	0.2893	7.35	42.39
2	0.2576	6.54	33.61
3	0.2294	5.83	26.65
4	0.2043	5.19	21.14
5	0.1819	4.62	16.76
6	0.162	4.11	13.29
7	0.1443	3.67	10.55
8	0.1285	3.26	8.36
9	0.1144	2.91	6.63
10	0.1019	2.59	5.26
11	0.0907	2.30	4.17
12	0.0808	2.05	3.31
13	0.072	1.83	2.63
14	0.0641	1.63	2.08
15	0.0571	1.45	1.65
16	0.0508	1.29	1.31
17	0.0453	1.15	1.04
18	0.0403	1.02	0.82
20	0.032	0.81	0.52
22	0.0254	0.65	0.33
24	0.0201	0.51	0.20

The tables below provide general guidelines for choosing wire. Remember that common ground wires must be adequate to carry the total amperage on the circuit, even if separate hot wires are used.

The data included here only illustrates general wiring principles. Variables such as the exact type of wiring used and the type of devices connected will effect the actual performance of any circuit. Always verify proper operation after installation.

### Wire Gauge Required for 3% Voltage Drop at 12 Volts

Circuit Length	Total Circuit Amps						
	1	5	10	20	30	40	50
10'	18	16	14	12	10	8	8
20'	16	14	12	8	6	6	4
30'	16	12	10	6	4	4	2
40'	16	12	8	6	4	2	2
50'	16	10	8	4	2	2	1
60'	16	10	6	4	2	1	0
80'	14	8	6	2	1	0	00
100'	14	6	4	2	0	00	000
120'	14	6	4	1	00	000	0000

### Wire Gauge Required for 10% Voltage Drop at 12 Volts

Circuit Length	Total Circuit Amps						
	1	5	10	20	30	40	50
10'	24	18	18	16	14	14	12
20'	22	18	16	14	12	10	10
30'	20	18	16	12	10	8	8
40'	20	16	14	10	8	8	6
50'	18	16	12	10	6	6	2
60'	18	16	12	8	4	4	2
80'	16	10	8	4	2	2	1
100'	16	8	6	4	2	1	0
120'	14	8	6	2	1	0	00

- STT
- TURN
- MARKER
- B-U/UTIL
- SPEC
- EMERG
- ECE
- MOUNT
- ELECT
- REFLECT
- ACCY
- MERCH
- TECH

**INTERNATIONAL IP (Ingress Protection) RATINGS EXPLAINED**

1st Digit		2nd Digit	
Protection Level Against Solid Ingress		Protection Level Against Liquid Ingress	
0	Non-protected (or not rated)	0	Non-protected (or not rated)
1	> 50 mm gap for entry	1	Vertically dripping water
2	> 12 mm gap for entry	2	Dripping water tilted at 15 degrees
3	> 2.5 mm gap for entry	3	Spraying water at an angle of 60 degrees
4	> 1.0 mm gap for entry	4	Splashing water at any direction
5	Dust resistant	5	Jets of water from any direction
6	Dust tight	6	Heavy seas or powerful jets of water
		6K	Powerful water jets with increased pressure
		7	Harmful ingress of water when immersed to 1 meter for 30 min.
		8	Continuous immersion in water
		9K	Powerful high temperature water jets

**Example: IP67 = [6] dust tight + [7] immersible up to 1 meter for 30 minutes**

fractional inch	decimal inch	millimeters
	0.010	0.25
	0.020	0.5
1/32	0.031	0.794
	0.039	1
	0.050	1.27
1/16	0.063	1.588
	0.079	2
	0.100	2.54
	0.118	3
1/8	0.125	3.175
	0.150	3.81
	0.157	4
3/16	0.188	4.763
	0.197	5
1/5	0.200	5.08
	0.236	6
1/4	0.250	6.35
	0.276	7
	0.300	7.62
5/16	0.313	7.938
	0.315	8
1/3	0.333	8.466
	0.350	8.89
	0.354	9
3/8	0.375	9.525
	0.394	10
2/5	0.400	10.16
	0.433	11
7/16	0.438	11.113
	0.450	11.43
	0.472	12
1/2	0.500	12.7
	0.512	13
	0.550	13.97
	0.551	14
9/16	0.563	14.288
	0.591	15
3/5	0.600	15.24
5/8	0.625	15.875
	0.630	16
	0.650	16.5
2/3	0.666	16.933

fractional inch	decimal inch	millimeters
	0.669	17
11/16	0.688	17.463
	0.700	17.78
	0.709	18
3/4	0.750	19
	0.787	20
4/5	0.800	20.32
13/16	0.813	20.638
	0.827	21
	0.850	21.59
	0.866	22
7/8	0.875	22.225
	0.900	22.86
	0.906	23
15/16	0.938	23.813
	0.945	24
	0.950	24.13
	0.984	25
1	1.000	25.4
1 1/4	1.250	31.75
1 1/2	1.500	38.1
1 3/4	1.750	44.45
	1.969	50
2	2.000	50.8
2 1/4	2.250	57.15
2 1/2	2.500	63.5
2 3/4	2.750	69.85
	2.953	75
3	3.000	76.2
3 1/4	3.250	82.55
3 1/2	3.500	88.9
3 3/4	3.750	95.25
3 15/16	3.937	100
4	4.000	101.6
4 1/4	4.250	107.95
4 1/2	4.500	114.3
4 3/4	4.750	120.65
	4.921	125
5	5.000	127
	5.906	150
6	6.000	152.4
	6.890	175

fractional inch	decimal inch	millimeters
7	7.000	177.8
7 7/8	7.874	200
8	8.000	203.2
	8.858	225
9	9.000	228.6
	9.843	250
10	10.000	254
	10.827	275
11	11.000	279.4
	11.811	300
12	12.000	304.8
	12.795	325
13	13.000	330.2
	13.780	350
14	14.000	355.6
	14.764	375
15	15.000	381
15 3/4	15.748	400
16	15.000	406.4
	16.732	425
17	17.000	431.8
	17.717	450
18	18.000	457.2
	18.701	475
	19.685	500
21	21.000	533.4
	21.654	550
	23.622	600
24	24.000	609.6
	25.591	650
	27.559	700
	29.528	750
30	30.000	762
31 1/2	31.496	800
	33.465	850
	35.433	900
36	36.000	914.4
	37.402	950
	39.370	1 meter
	78.740	2 meters
	196.85	5 meters



STT
TURN
MARKER
B-U/UTIL
SPEC
EMERG
ECE
MOUNT
ELECT
REFLECT
ACCY
MERCH
TECH

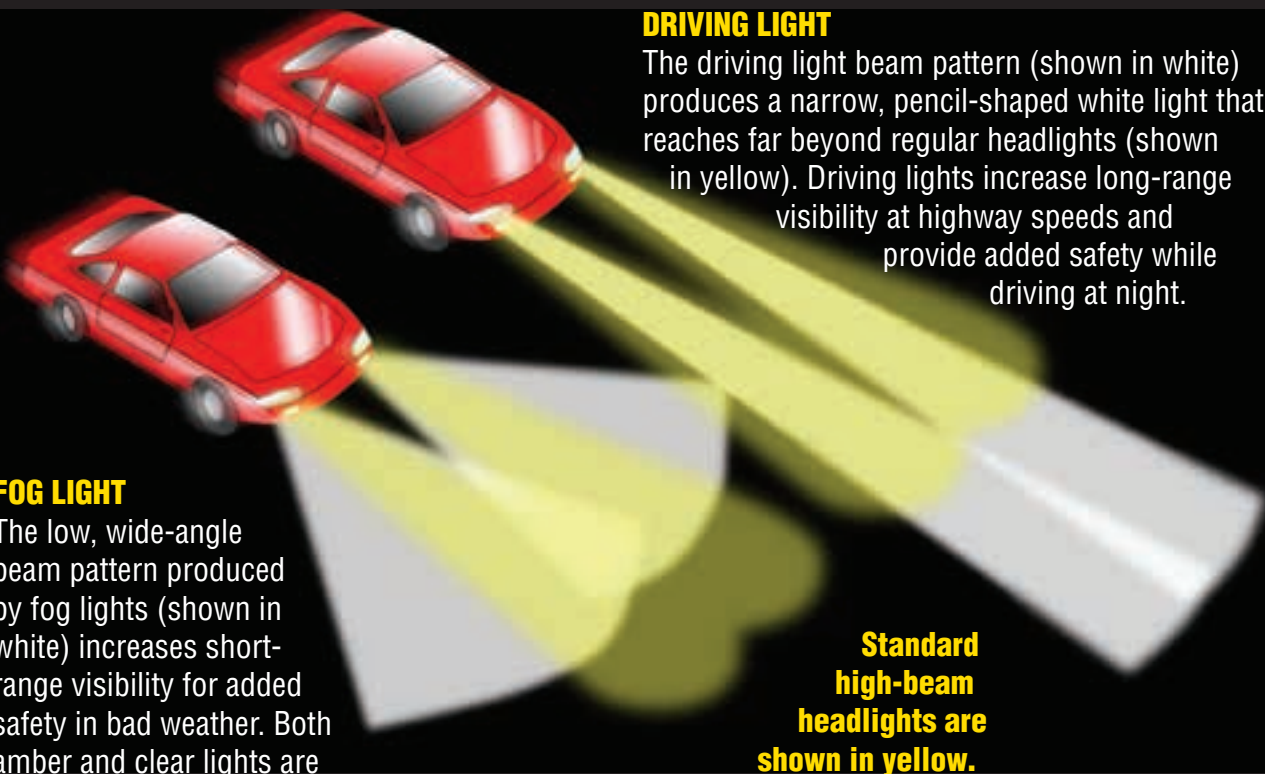

**FOG LIGHT**

The low, wide-angle beam pattern produced by fog lights (shown in white) increases short-range visibility for added safety in bad weather. Both amber and clear lights are available. Amber, while not as penetrating, is more visible to approaching vehicles.

**DRIVING LIGHT**

The driving light beam pattern (shown in white) produces a narrow, pencil-shaped white light that reaches far beyond regular headlights (shown in yellow). Driving lights increase long-range visibility at highway speeds and provide added safety while driving at night.

**Standard high-beam headlights are shown in yellow.**

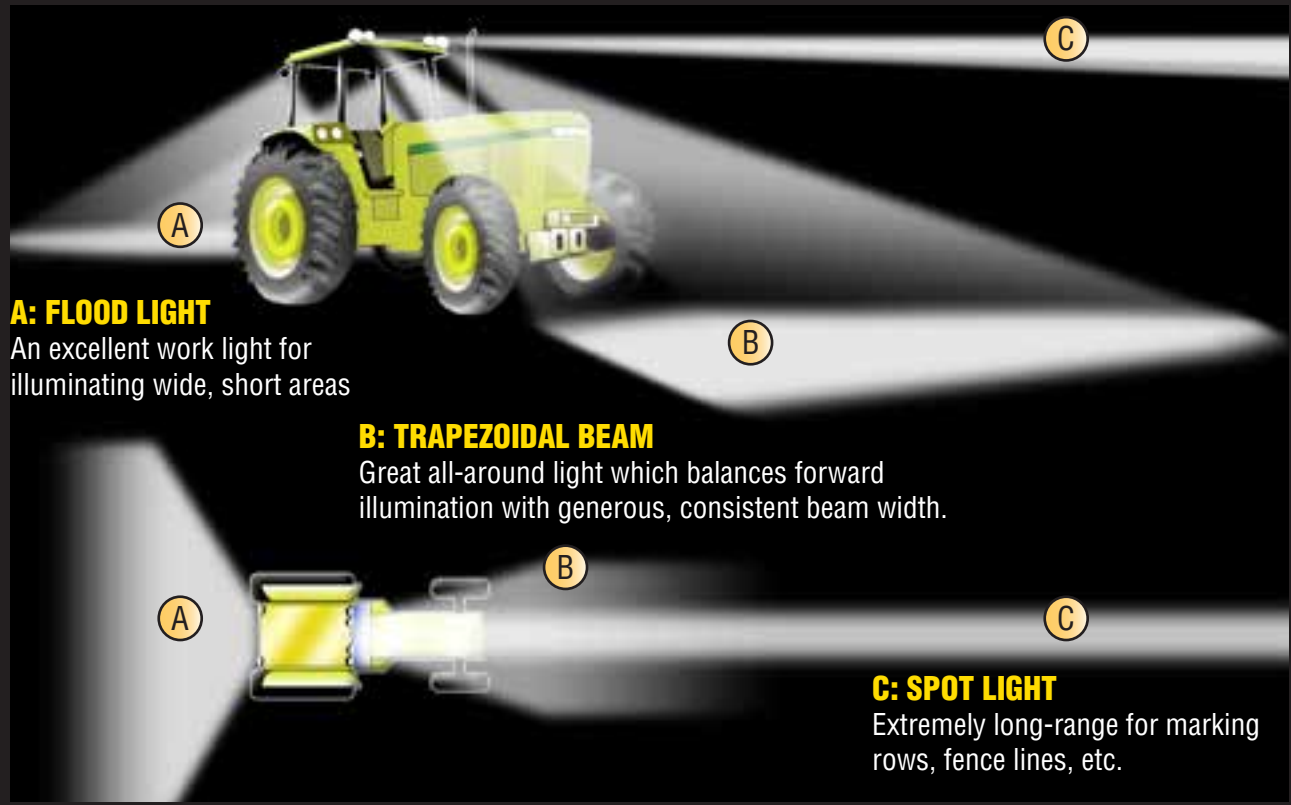

**A: FLOOD LIGHT**

An excellent work light for illuminating wide, short areas

**B: TRAPEZOIDAL BEAM**

Great all-around light which balances forward illumination with generous, consistent beam width.

**C: SPOT LIGHT**

Extremely long-range for marking rows, fence lines, etc.

## LED AMP DRAW SPECIFICATIONS

Part No.	@12V (Color 1/2)	@24V (Color 1/2)
35A-MV/R-MV	0.09	0.05
38A-MV/R-MV	0.09	0.05
60A-MV/R-MV	0.03	0.04
72 R	0.07	
121A	0.12	
129A/R	.04/.04	
133A/R	.03/.06	
153A/R	.04/.04	
153C-MV	0.07	0.08
153C-P	0.07	
153CTP-BT3	0.14	
161A/R	.02/.02	
161A-R	0.08	
162A/R	.05/.05	
163A/R	.18/.14	
163A-MV/R-MV	.16/.12	.08/.07
164A/R	.05/.05	
165A/R	.18/.14	
165A-MV/R-MV	.16/.12	.08/.07
166A/R	.03/.03	
168A/R/CA/CR	.04/.04/.04/.04	
168A-MV/R-MV	.03/.03	.03/.03
168C	0.03	
169-3R/3A	.11/.11	
169A/R	.03/.03	
170A/R	.04/.04	
171A/C/R	0.07	
171W-MV	0.03	0.04
173A/R	.08/.08	
175A/R	.04/.04	
176A/R	.07/.07	
176RGB	.04 per color	
177A/R	.07/.07	
177-3R	0.25	
178A/R/CA/CR	.06/.07/.06/.07	
178A-MV/R-MV / A-MVC	.06/.06/.06	.04/.04/.04
178W-MV	0.02	0.02
179A/R	.09/.1	
180A/R	.03/.03	
181A/R	.07/.04	
181A-MV/R-MV	0.03	0.04
186A/R	0.07	
186W	0.13	
186CTP	0.08	
186-3R	0.25	
187A/R	0.05	
187A-MV/R-MV	.05/.05	.03/.03
188A/R	.07/.04	
189FA/FR	.06/.06	
190FA/R	.05/.06	

Part No.	@12V (Color 1/2)	@24V (Color 1/2)
191-3RL	0.11	
191A/R	.04/.03	
192A/R	.04/.05	
193A/R	.10/.14	
193A-MV/R-MV	0.07	0.04
194A/R	.05/.05	
195A/R	.19/.15	
195A-MV	0.19	0.09
195R-MV	0.16	0.08
196A/R	.04/.04	
197A/R	.04/.04	
198A/R	.04/.04	
199A/R	.04/.04	
203A/R	0.055	
203C/W	0.04	
215A/R	.01/.01	
233A	0.48	
233A low light	0.02	
233R	0.23	
233R low light	0.03	
233CA	0.48	
233CA low light	0.02	
233CR	0.23	
233CR low light	0.03	
250W-BT2	0.11	
253A/R	.07/.08	
253A/R low light	.02/.02	
253SA-1/-2	0.42	0.2
253SW-1/-2	0.375	
271A/R	.07/.07	
271A/R low light	.01/.01	
272A/R	.09/.09	
274A/R	.07/.07	
277K/KL	0.12/.08	
286A/R	.17/.17	
286A/R low light	0.03/.03	
290/290C	0.05	
290-MV/290C-MV	0.04	0.03
291C-BT2	0.07	
296C/XC	0.01	
298C	0.02	
318L/R	1.25/1.25	
318L/R low light	.01/.01	
318L/R red	0.2/0.2	
319AA	0.45	
319AA low light	0.03	
319R	0.07	
319R low light	0.01	
320A/321A	0.31	
320A/321A Low light	0.02	

Part No.	@12V (Color 1/2)	@24V (Color 1/2)
327L/R	.19/.19	
327L/R flashing	.05/.05	
338-2	0.23	
339A/R	.20/.09	
350A-P	0.2	0.38
350A-P low light	0.04	0.09
351A	0.2	0.38
351A low light	0.04	0.09
353A/R	0.15	
353A/R low light	.02/.11	
355A	0.2	0.34
355A low light	0.04	0.09
356A	0.54	
356A low light	0.03	
358-1/-2/-3/-4	.28/.17/.36/.36	
359-1/-2/-3/-4	.28/.17/.36/.36	
360/360-1	1.82	0.93
362-1/-2	.13/.13	
363-1/-2	.28/.24	
364-1	0.49	0.9
365	1.75	
366	0.14	
368	0.11	
369S	0.1	
370	0.21	
371	0.22	
379S	0.12	
381	0.09	
388A/R	.10/.11	.07/.07
388C	0.07	0.06
388WB	0.07	0.04
397C	0.11	0.58
398-BT2	0.39	0.2
417R/R-P	0.17	
417R/R-P low light	0.05	
417TA-P	0.2	
417TA-P low light	0.11	
418R/R-P	0.17	
418R/R-P low light	0.05	
418TA-P	0.4	
418TA-P low light	0.11	
418R-4	0.14	
420QA-P	0.4	
420QA-P low light	0.03	
420R/423R	0.46	1.23
420R/423R low light	0.02	0.1
423A-4	0.26	0.15
423A-4 low light	0.05	0.03
423QA-P	0.14	
423QA-P low light	0.03	

Part No.	@12V (Color 1/2)	@24V (Color 1/2)
423W-4	0.16	0.1
701C & 701C-ECE	1.96	0.97
702C	1.05	
703C	1.17	
705C	0.51/2.23	
711	1.45	0.715
717A	0.27	0.13
717C	0.25	0.12
717R	0.14	0.08
717R low light	0.06	0.3
744A	0.1	
745A	1.14	0.46
748A	0.26	0.1
748C	0.287	0.102
751A	2.88	1.44
752A/752MA	1.16/1.49	.48/.76
762A	0.18	0.18
764A	0.17	0.08
764A-2	0.21	0.1 (.07 @ 36V)
772A	0.09	
778A	2.724	
779-1A	3.59	
789A	2.43	1.16
791A/MA	1.15/1.14	.48/.60
792C	1.3	0.65
794A-1 & 2	.28/.47	.25/.18
797A	0.57	0.28
798A	2.1	1
799A	1.2	0.6
800W-9	0.65	
814R/816R	0.27	
814R/816R low light	0.02	
817A-7/818A-7	0.24	
817A-7/818A-7 low light	0.01	
817A-9/818A-9	0.24	0.15
817A-9/818A-9 low light	0.02	0.03
817A-36/818A-36	0.53	
817A-36/818A-36 low light	0.04	
817C-7/818C-7	0.23	
817C-9/818C-9	0.35	
817CR-2/818CR-2	0.08	0.15
817CR-2/818CR-2 low light	0.01	0.01
817CR-36/818CR-36	0.33	0.17
817CR-36/818CR-36 low light	0.02	0.03
817R-36/818R-36	0.53	
817R-36/818R-36 low light	0.04	
817R-7/818R-7	0.35	
817R-7/818R-7 low light	0.01	
817R-9/818R-9	0.21	0.38
817R-9/818R-9 low light	0.02	0.05

## LED AMP DRAW SPECIFICATIONS

Part No.	@12V (Color 1 / 2)	@24V (Color 1 / 2)
817SA-1/-2	0.36	0.36
817SA-9/818SA-9	0.59	0.45
817SR-9/818SR-9	0.59	0.45
817SW-9/818SW-9	0.59	0.45
817TA-2C & 818TA-2C	.34 / .33	.21 / .20
817TA-2C & 818TA-2C flashing	.09 / .09	.07 / .07
817W-9	0.38	0.27
817YA/818YA flashing & steady	0.79	
817YA/818YA low light	0.02	
818SA-1/-2	0.36	
820A-7/823A-7	0.29	
820A-7/823A-7 low light	0.03	
820A-10/823A-10	0.3	0.15
820A-10/823A-10 low light	0.02	0.03
820A-22/823A-22	0.36	
820A-22/823A-22 low light	0.02	
820C-7/823C-7	0.23	
820C-10/823C-10	0.22	0.49
820QA/823QA	0.45	0.55
820QA/823QA low light	0.2	0.24
823QCA	0.45	0.55
823QCA low light	0.02	0.24
820R-7/823R-7	0.24	
820R-7/823R-7 low light	0.01	
820R-10/823R-10	0.33	0.17
820R-10/823R-10 low light	0.02	0.03
820R-22/823R-22	0.36	
820R-22/823R-22 low light	0.02	
820SA-1/-2, 823SA-1/-2	0.24	0.17
820SR-1/-2	0.24	0.17
820SA-10/823SA-10	0.52	0.4
820SR-10/823SR-10	0.52	0.4
820SW-10/823SW-10	0.52	0.4
821A-7/822A-7	0.24	
821A-7/822A-7 low light	0.01	
821A-10/822A-10	0.3	0.15
821A-10/822A-10 low light	0.02	0.03
821A-22/822A-22	0.36	
821A-22/822A-22 low light	0.02	
821C-7/822C-7	0.23	
821R-7/822R-7	0.22	
821R-7/822R-7 low light	0.01	
821R-10/822R-10	0.33	0.17
821R-10/822R-10 low light	0.02	0.03
821R-22/822R-22	0.36	
821R-22/822R-22 low light	0.02	
826A-MV/824A-MV	0.17	0.1
826A-MV/824A-MV low light	0.04	0.03
826C-MV/824C-MV	0.18	0.09
826R-MV/824R-MV	0.12	0.07

Part No.	@12V (Color 1 / 2)	@24V (Color 1 / 2)
826R-MV/824R-MV low light	0.03	0.02
826R/824R	0.27	
826R/824R low light	0.02	
826A-7/824R-7	0.24	
826A-7/824R-7 low light	0.01	
826C-7/824C-7	0.38	
826R-7/824R-7	0.41	
826R-7/824R-7 low light	0.01	
826A-9/824A-9	0.24	0.15
826A-9/824A-9 low light	0.02	0.03
826C-7/824C-7	0.23	
826R-9	0.21	0.38
826R-9 low light	0.02	0.05
827R	0.17	
827R low light	0.01	
829C-7	0.4	
829R-7	0.39	
829R-7 low light	0.01	
840/840L	.28 / .33	
840/840L low light	.11 / .15	
844/844L	0.6	
844/844L low light	0.25	
845/845L	.19 / .16	
845/845L low light	.08 / .14	
850A/850A-1	0.38	0.21
850A-R	0.23	0.14
850A-R low light	0.16	0.1
850C	0.66	0.33
850F-SW	0.3	0.3
850F-C-SW	0.67	0.33
850R/850R-1	0.37	0.21
850R/850R-1 low light	0.04	0.05
850SA	0.125	0.06
856	0.15	
856 low light	0.05	
856L	0.19	
856L low light	0.09	
860SA-1/-2 (turn/strobe)	.33 / .35	.30 / .26
861SA-1/-2 (turn/strobe)	.33 / .35	.21 / .27
861SA-1/-2/-3/-4 (turn/strobe)	.66 / .77	.42 / .54
866SA-1/-2 (turn/strobe)	.48 / .50	.31 / .40
866SA-1/-2/-3/-4 (turn/strobe)	1-Jan	.62 / .80
867SA-1/-2 turn (turn/strobe)	.33 / .35	.3 / .25
869R	0.16	
869R low light	0.01	
870W	0.27	0.19
872W	0.28	0.18
880-7/881-7	0.19	
880-7/881-7 low light	0.02	
880-7/881-7 reverse	0.51	

Part No.	@12V (Color 1 / 2)	@24V (Color 1 / 2)
882-7/883-7	0.18	
882-7/883-7 low light	0.02	
882-7/883-7 reverse	0.51	
901-MV	0.57	0.27
903-MV	2.89	1.27
904-MV	1.07	0.51
905-MV	0.4	0.2
906-MV	0.82	0.4
907	0.2	0.12
907-MV	0.29	0.22
908	1.61	0.76
910-MV/910M-MV	1.73	0.83
911-MV	1.15	0.61
912-MV	NA	
913-MV	1.5	0.74
915-MV	2.8	1.5
916S	0.38	0.27
918S	0.65	
919-MV	1.64	0.83
920B-MV	0.6	0.3
921-MV	1.23	0.59
928-MV	2.15	1.03
930-MV	16.5	7.7
931-MV	12.7	6
932-MV	3.4	1.77
933-MV	3.36	1.53
934-MV	7.98	3.14
1288	0.03	0.03
1289	0.24	0.14
1197SA	0.14	
1200A/C/R	.04 / .01 / .02	.04 / .01 / .02
1203A/C/R	0.32	0.19
1217A-1/-1C	0.07	0.19
1217A-1/-1C low light	0.13	0.19
1217A-9	0.13	0.08
1217A-R	0.04	0.02
1217A-R low light	NA	
1217C-9	0.29	0.15
1217F	0.38	0.19
1217F-C	0.09	0.06
1217G-R	0.17	0.29
1217R-9	0.02	0.06
1217R-9 low light	0.18	0.18
1218A-1	0.07	0.19
1218A-1 low light	0.32	0.18
1218A-1C	0.14	0.2
1218A-9	0.12	0.08
1218A-R	0.15	0.09
1218A-R amber	0.03	0.02
1218A-R low light	0.17	0.29

Part No.	@12V (Color 1 / 2)	@24V (Color 1 / 2)
1218R-9	0.02	0.06
1218R-9 low light	0.13	0.21
1220A-10	0.21	0.44
1220C-10	0.21	0.37
1220R-10	0.02	0.05
1220R-10 low light	0.13	0.07
1223A-4	0.15	0.08
1223A-R-MV	0.001	0.01
1223A-R-MV low light	0.21	0.36
1223R-10	0.02	0.06
1223R-10 low light	0.11	0.06
1223R-4	0.04	0.02
1223R-4 low light	0.06	
1268A-MTC	.03 / .03	.03 / .03
1268A-MV/-MVC	0.02	0.02
1268A-R-MV	.03 / .02	.02 / .02
1268R-MV/-MVC	0.01	0.01
1268W-MV	0.18	0.19
1288 low light	0.19	0.1
1288 back up	0.07	0.06
1288 side marker	0.12	0.08
1288 turn	0.35	0.19
1288A	0.16	0.09
1288B	0.18	0.1
1288C	0.17	0.11
1288F	0.17	0.09
1288R	0.07	0.04
1288R low light	0.08	0.07
1288TA	0.13	0.07
1289 low light	0.21	0.14
2217A-R/2218A-R/2219A-R High Red (Brake)	0.145	0.08
2217A-R/2218A-R/2219A-R Amber Turn	0.065	0.037
2217A-R/2218A-R/2219A-R low light	0.02	0.018
2217F-C/2218F-C/2219F-C Rev 2 fcn	.17 / .24	.09 / .12
2217F-C/2218F-C/2219F-C Fog 2 fcn	0.24	0.12
2268A-R-MV	0.03	
2290A-R (Red High/Brake) 3fcn	0.14	0.08
2290A-R (Amber Tm) 3fcn	0.12	0.067
2290A-R low light	0.019	0.017
2291A-R (Red High/Brake) 3fcn	0.3	0.16
2291A-R (amber/Tm) 3fcn	0.2	0.11
2291A-R low light	0.025	0.015
2291F-C Rev/Fog 2 fcn	.29 / .30	.14 / .14
4484A-1/R-1	0.04	
4153SA	0.8	0.44
4154SA	0.8	0.44
4155SA	1	1
4156SA	0.33	0.18

ST  
TURN  
MARKER  
B-U/UTI  
SPEC  
EMERG  
ECE  
MOUNT  
ELECT  
REFLECT  
ACCY  
MERCH  
TECH

## GROMMET & FLANGE MOUNTING DIMENSIONS

Dimensions given are for reference only. Due to various panel thickness, the size of the hole may need to be adjusted.

Grommet No.	Description	Hole Size	Max. Panel Thickness
127-18	Grommet, rectangle, flush mount, black	3.50" x 2.40"	0.16"
127-181	Grommet, rectangle, flush mount, white	3.50" x 2.40"	0.16"
142-17	Grommet, round, raised mount	2.75" diameter	0.18"
142-18	Grommet, round, recess mount	3.125" diameter	0.18"
142-181	Grommet, round, recess mount	3.125" diameter	0.18"
143-17	Grommet, round, flush mount, closed-back	3.125" diameter	0.15"
143-18	Grommet, round, flush mount	2.75" diameter	0.25"
144-18	Grommet, round, flush mount, closed-back	2.75" diameter	0.075"
146-18	Grommet, round, flush mount	2.25" diameter	0.25"
146-181	Grommet, round, raised mount	2.125" diameter	0.25"
146-182	Grommet, round, flush mount, closed-back	2.25" diameter	0.25"
146-184	Grommet, round, raised mount	2.25" diameter	0.17"
150-18	Grommet, rectangle, flush mount	2.88" x 1.53"	0.25"
150-181	Grommet, rectangle, flush mount	3.00" x 1.65"	0.25"
177-18	Grommet, round, flush mount	0.75" diameter	0.20"
421-18	Grommet, oval, flush mount	2.50" x 6.75" 1.25" r. corners	0.0179–0.25"
426-18	Grommet, round, flush mount	4.50" diameter	0.25"
450-18	Grommet, rectangular, flush mount	5.43" x 3.58"	0.23"
850-18	Grommet, rectangular, flush mount	5.43" x 3.58"	0.375"

Lamp Series w/ Flange	Lamp Type	Mounting Hole Diameter
411, 413, 418, 424, 425, 814, 818, 824	4" Round	4.5"
350F, 354F, 423, 822, 823, 2875	Oval	6.75" x 2.5"
162, 163, 175, 192, 193, 197	2 1/2" Round	2.75"
146, 164, 165, 194, 195, 199	2" Round	2.25"



## INSTALLING PETERSON LIGHTS WITH INTEGRAL WEATHERPROOF CONNECTOR RECEPTACLES

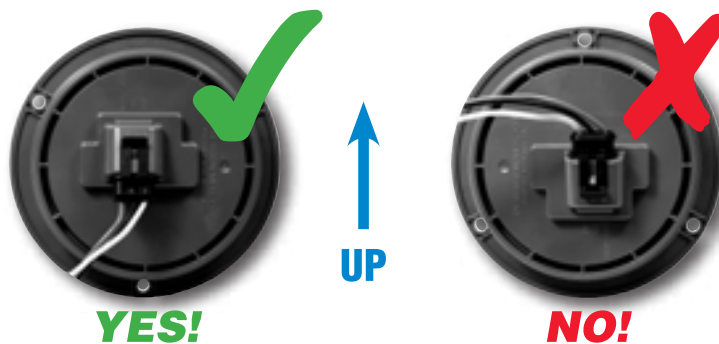

Many Peterson LED vehicle lights have an angled receptacle built into the rear of the housing. This receptacle is designed to accept AMP SuperSeal 1.5 Series and compatible sealed, weatherproof plugs. While this type of plug is among the very best in the industry at keeping out moisture and foreign matter, proper installation will ensure these lights provide the very longest, most trouble-free service life possible.

When installing these lights, the light housing should be oriented on the vehicle so that the receptacle opening faces downward. This will protect the light and wiring in two ways:

1. The housing shrouds the opening to help keep environmental liquids and debris from dropping or running down into it.
2. Material that does come into contact with the sealing surfaces will be drawn by gravity down, out and away, rather than being pulled further into the connector.

It is important to always orient the receptacle opening properly when attaching the housing to the vehicle body. When doing maintenance on a vehicle, verify the orientation of the light housings whenever possible.

## OBSOLETE PART NUMBERS

The following parts previously offered by Peterson are no longer available and do not appear in this catalog.

18-41	153SB-2	M305A	417SA-2	M450A	794A-2	M4260RF
B61	153SC-1	M305R	417SR-1	M450C	V809	4332
104-3R	153SC-2	M306A	417SR-2	450KC	817SW-1	4333
M104-3R	153SR-1	M306R	M417TA	461RSK	817SW-2	4343A-1
M104A	153SR-2	308-15A	417YA-P	468K	820R-10	4343A-1X
M104R	B154-12K	308L-PKD	M418C-1	B473A	831	4343A-2
107-3A	154-49	308R-PKD	M418C-1P	B473R	833	4343A-2X
V107-6A	B154-121K	310-15R	418C-P	B485A	850-092HAR	4343A-3
M107WA-24	160-3R	V314MA	M418C-P	B485R	850-092VAR	4343A-3X
M112A	160-493	319AA-P	418SA-1	V490A	850-093HARC	4343A-4
M115A	M160A	319R-P	418SA-2	V490R	850-093HARR	4343A-4X
M115R	160KA	325-2	418SR-1	M503HT	850-093VARC	4344A-1
117A	V160KA	325-15A	418SR-2	V504HFM	850-093VARR	4344A-2
B119-15B	160KR	325-15R	M418TA	V506	850A-R	4344A-3
B119-15G	V160KR	325-151A	418YA-24V	507F	850A-R-SW	4344A-4
120-49	M160R	326-2	418YA-P	V507F	850C-BT2	4353A-1
M120A	B162-491	335	419	508	M850F-C	4353A-1X
V120A	B167-09	B338-15B	M420HC-1AMP	M509	850HC	4353A-2
M120A-1	B167-49	338-18	M420HC-1P	V509	850R-AMP	4353A-2X
M120R	B167-491	V339-2	M420R	511	M852	4353A-3X
M120R-1	B167-492	M350AF-PKD	M420R-P	M513	M852L	4353A-4X
M129R-BT2	M167A	360-25C	420SA-1	V520-10	V869R	4547
B134-15C	167KA	M361	420SA-1AMP	B521-20C	M881TL-7	4741B-MV
136-3A	V167KA	V361	420SA-2	M525S	902-MV	4741C
M138A-24V	167KR	367	420SA-2AMP	V531	V902-MV	4741C-MV
M138B-24V	V167KR	M367	420SB-1	V538	909-MV	4741G
M138C-24V	M167R	M368-BT2	420SB-2	M545	V911-MV	4741G-MV
M138G-24V	176A-BT2	M368-MLX	420SR-1	V552-2	914S-MV	4741P
M138R-24V	176R-BT2	375-15W	420SR-2	V556-2	V940	4741P-MV
B140-24	B177-181	V375S	M420VC-1P	V557-2	1195	4741PK
M142A-24V	V179A	V376S	B421-493	B560	1200-09V	4741PK-MV
M142R-24V	V179R	M382A	M421A-24V	V562-1	1283A	4741T
M145A	M180A-24V	M383A	421R-24V	V581B-2PL	1283R	4741T-MV
M145R	M180R-24V	M383C	M421R-24V	V581C-2PL	1283W	4741Y
B146-184	PMD180-100-10	M392C	423HSA-1	V583-2	M1290A-R	4741Y-MV
M146A-24V	M214A	V392C	423HSA-2	M584	V2546-15A	5100
M146FA	V214A	393A	423QA-P-24V	M588	V2546-15R	5124
M146FR	M214A-BT1	394C	M423R	V590-2	V2546A	5200
146KA	215-15A	410-25A	M423R-P	V597-2	V2546R	5300
M146R-24V	215-15R	B411-07	423SA-1	V599	V2547-15A	5400
M147A	M233SR	B413-07	423SA-1AMP	V600B-2	V2547-15R	5424
M150-3A	272KR	M413-24V	423SA-2	V603L	V2547A	V7011S
V150-3R	M272R	416-24V	M423VC-1P	V604	V2547R	V7013
B150-097	294-09	417-093ARC	424-15R	617XH	M2875A-P	8344A-1
152-09	294	417-093ARR	424R	672X	M2875AF-P	8344A-2
152-091	M294	B417-482	M425-3	700-15C	4169A	8363A-1
B153-493	V294	B417-486	426A-24V	748-25A	4169R	8363A-2
B153-494	M294C	417C	431A	748-25C	4177CA	95041-1
153C-143	M294C-BT2	M417C-1	M431A	748A	4177CR	95080-1
153C-BT236	M294C-PKD	M417C-1AMP	431KR	748C	4258A-1	95091-1
M153C-BT236	M294WW-MV	M417C-1P	433-15C	766-25A	4258A-1X	PMPL10-100-12
153KC-BT236	M294-BT2	M417C-BT2	M433S	766A	4258A-2	PMPL3-100-12
153SA-1	M294-MV	417C-P	437	V766MA	4258A-2X	
153SA-2	305-25A	M417C-P	M439B	766ST	M4260A	
153SB-1	305-25R	417SA-1	449-2	794A-1	M4260R	

STT

TURN

MARKER

B-U/UTIL

SPEC

EMERG

ECE

MOUNT

ELECT

REFLECT

ACCY

MERCH

TECH

## Grote

GROTE..... PETERSON	GROTE..... PETERSON	GROTE..... PETERSON	GROTE..... PETERSON	GROTE..... PETERSON	GROTE..... PETERSON
61E81.....358-3	40133-5.....V487A	43362-3.....421-09	45172.....119R	46282.....123R	47123-3.....M196A
61F81.....M365	40152.....476R	43370.....150-091	45173.....119A	46283.....123A	47202.....M162FR
64J11.....V933-MV	40152-3.....B476R	43380.....150-091	45232.....127R	46302.....130R	47212.....166R
64J21.....V934-MV	40153.....476A	43390.....154-09K	45232-3.....M127R	46302-3.....M130R	47212-3.....M166R
12004.....V603	40153-3.....B476A	43411.....45	45233.....127A	46303.....130A	47213.....166A
12004-5.....V603	40192.....B460R	43411-3.....45	45233-3.....M127A	46303-3.....M130A	47213-3.....M166A
12052.....655	40193.....B460A	43424.....45	45252.....136R	46393-5.....V112A	47232.....197R
12053.....655X	40232.....B472R	43463.....7005S	45252-3.....M136R	46412.....150R	47232-3.....M197R
12071.....609	40232-3.....B472R	43463-3.....B7005S	45252-5.....V136R	46412-3.....M150R	47233.....197A
12072.....830	40232-5.....V472R	43512.....143-092	45253.....136A	46412-5.....V150R	47233-3.....M197A
12073.....830	40233.....B472A	43522.....143-092	45253-3.....M136A	46413.....150A	47322.....163R-MV
12073-5.....830	40233-5.....V472A	43532.....146-092	45253-5.....V136A	46413-3.....M150A	47323.....163A-MV
12113-5.....832	40302.....B483R	43572.....426-09	45262.....135R	46413-5.....V150A	47332.....165R-MV
12153.....668X	40303.....B483A	43655.....426-10	45262-3.....M135R	46422-5.....V150KR	47333.....165A-MV
12164.....V602	40641.....467-1	43655-3.....426-10	45262-5.....V135R	46423-5.....V150KA	47372.....M197FR
12164-5.....V602	40641-5.....467-4K	43673.....B106-09	45263.....135A	46543.....M118A	47372-3.....M197FR
12172.....608XO	40650.....465-2	43673-5.....V106-09	45263-3.....M135A	46543-5.....V118A	47373.....M197FA
12173.....608XO	40650-5.....465-4K	43780.....B154-09	45263-5.....V135A	46702.....108WR	47472.....V196KR
12182.....608	41002.....481R	43783.....B154-10	45333.....V109A	46703.....108WA	47473.....V196KA
12183.....608X	41003.....481A	43790.....154-09K	45412.....M102R	46712.....108WR	47502.....M129R
12201-5.....V600	41012.....477R	43790-3.....154-09K	45412-3.....M102R	46712-5.....V108WR	47502-3.....M129R
12243-5.....832	41013.....477A	43823.....7007S	45412-5.....V102R	46713.....108WA	47503.....M129A
12263-5.....836	41032.....B480R	43823-3.....B7007S	45413.....M102A	46713-5.....V108WA	47503-3.....M129A
12272-5.....658X	41032-3.....B480R	43842.....440-09	45413-3.....M102A	46740.....154A-R	47772.....M178CR-BT2
12293.....608X	41032-5.....V480R	43850.....154-09K	45413-5.....V102A	46742.....154R	47773.....M178CA-BT2
12983.....608X	41033.....B480A	43850-3.....154-09K	45432.....135R	46742-3.....M154R	47853-5.....V170A
16023.....617X	41033-5.....V480A	43901.....46	45433.....135A	46742-5.....V154R	47912.....4354R
16032.....608	41042.....B479R	43960.....150-14	45442.....130R	46743.....154A	47913.....4354A
16033.....608X	41043.....B479A	43960-3.....B150-14	45443.....130A	46743-3.....M154A	48072.....500
16091.....616W	41050.....464-2	43970.....150-09 / 142-49	45462.....130R	46743-5.....V154A	48272.....500
16092.....616	41133.....469-1	43970-3.....150-09 / B142-49	45463.....130A	46791.....M138C	48282.....V500
16123.....615	41142.....490R	43980.....150-10	45582.....V178XR	46792.....138R	49062.....136-3R
16244.....615	41143.....490A	44010.....5000	45583.....V178XA	46792-3.....M138R	49112.....107-3R
16284.....615	41152.....491R	44134.....18-41	45623.....V178A	46792-5.....V138R	49112-5.....V107-3R
18302-5.....598	41153.....491A	44421.....19-41	45662.....M137R	46793.....138A	49172.....150-3R
26001-5.....616W	41160.....465-1	44530.....570	45663.....M137A	46793-3.....M138A	49192.....169-3R
28032.....654	42103.....7011S	44530-3.....570	45812.....142R	46793-5.....V138A	49212-5.....V191-3RL
28033.....654X	42110.....176-10	44530-5.....V570	45812-3.....M142R	46832.....155R	49223.....M169-3A
28033-5.....654X	42112-3.....B176-10	44540.....571	45812-5.....V142R	46833.....155A	49242-5.....V169-3R
28042.....655	42120.....176-13	44540-3.....571	45813.....142A	46882.....107WR	49262.....M181R-MV-BT2
28043.....655X	42120-3.....B176-13	44690.....573	45813-3.....M142A	46882-5.....V107WR	49263.....M181A-MV-BT2
28093-5.....821	42141.....150-091	44690-3.....573	45813-5.....V142A	46883.....107WA	49322.....181KR-BT2
28152.....605	42141-3.....B150-091	44700.....574	45821.....146C	46883-5.....V107WA	49322-5.....V181R-BT2
28162.....605	42152.....820-09	44710.....576	45821-3.....M146C	46892.....M122XR	49323.....181KA-BT2
28323-5.....810	42152-3.....B820-09	44720.....577	45822.....146R	46892-5.....V122XR	49323-5.....V181A-BT2
28663.....655X	42153.....820-10	44730.....579	45822-3.....M146R	46893.....M122XA	49332.....176KR
40052.....B475R	42180.....165-10	44810.....554	45822-5.....V146R	46893-5.....V122XA	49333.....176KA
40052-3.....B475R	42282.....176-12	44810-3.....554	45823.....146A	46982-5.....V114R	49362.....M271R-BT3
40052-5.....V475R	42282-3.....176-12	44810-5.....V554	45823-3.....M146A	46983-5.....V114A	49363.....M271A-BT3
40053.....B475A	42292.....176-11	44820.....557	45823-5.....V146A	47012.....168R	49392.....187R
40053-3.....B475A	42292-3.....176-11	44840-5.....V520-40	45832.....143R	47012-3.....M168R	49393.....187A
40053-5.....V475A	42302.....176-14	44892.....571	45832-3.....M143R	47013.....168A	50222.....413
40062.....V475R	42302-3.....176-14	45002-5.....V168R	45833.....143A	47013-3.....M168A	50232.....413
40063.....V475A	42312.....176-16	45003-5.....V168A	45833-3.....M143A	47052.....V126R	50232-5.....V413
40072.....B481R	42312-3.....176-16	45012.....119R	45932.....M106R	47053.....V126A	50532.....440L
40072-3.....B481R	43022.....428-09	45013.....119A	45932-3.....M106R	47082.....153R	50542.....440
40072-5.....481R	43022-5.....V428-09	45022.....M110R	45933.....M106A	47083.....153A	50542-5.....V440
40073.....B481A	43100.....794-09	45022-5.....V110R	45933-3.....M106A	47092.....161R	50630.....313-2RA
40073-5.....481A	43120.....B154-092	45023.....M110A	46072.....155R	47093.....161A	50630-5.....V313-2RA
40092.....477R	43262-5.....V440-09	45023-5.....V110A	46073.....155A	47112.....198R	50642.....313-2
40093.....477A	43272.....428-09	45042.....142KR	46132.....165R	47112-3.....M198R	50642-5.....V313-2
40132.....B487R	43272-5.....V428-09	45043.....142KA	46133.....165A	47113.....198A	50872.....428
40132-3.....B487R	43282.....510-9	45062.....M146KR	46142.....163R	47113-3.....M198A	50872-5.....V428
40132-5.....V487R	43292.....510-9	45063.....M146KA	46142-3.....M163R	47122.....196R	50920.....845L
40133.....B487A	43343.....7009S	45092.....154KR	46143.....163A	47122-3.....M196R	50972.....445
40133-3.....B487A	43362.....421-09	45093.....154KA	46143-3.....M163A	47123.....196A	50972-5.....V445

## Grote (cont.)

GROTE.....	PETERSON	GROTE.....	PETERSON	GROTE.....	PETERSON	GROTE.....	PETERSON	GROTE.....	PETERSON	GROTE.....	PETERSON
50992.....	454	54032.....	818R-7	62171.....	415	67000.....	431-491	90153.....	136-15A	94000.....	142-18K
51962.....	840	54142.....	820R-7	62171-3.....	M415	67000-3.....	B431-491	90153-3.....	136-15A	94010.....	143-18K
51962-5.....	V840	54143.....	820A-7	62181.....	415K	67001.....	162-49	90162.....	100-15R	94100.....	146-18K
51972.....	840L	54172.....	821R-7	62181-3.....	415K	67001-3.....	B162-49	90163.....	100-15A	94180.....	450-18
51972-5.....	V840L	54173.....	821A-7	62231.....	416	67006.....	417-491MP	90172.....	130-25R	94180-3.....	B450-18
51982.....	844	54193.....	356A	62231-3.....	M416	67010.....	431-49	90173.....	130-25A	94233.....	150-10
51982-5.....	V844	54213.....	356AF	62251.....	416K	67011.....	431-49	90202.....	108-15R	94411-5.....	V703C
51992.....	844L	54282.....	826R-MV	62251-3.....	416K	67014.....	421-49	90202-5.....	V108-15R	94421-5.....	V702C
51992-5.....	V844L	54292.....	817R-9	62291.....	M393C	67050.....	142-49	90203.....	108-15A	99170.....	PM-ECK-T
52182.....	421R	54313.....	817A-9	62331.....	415K	67050-3.....	B142-49	90203-5.....	V10815A	99170-1.....	PM-ECK-T
52182-5.....	V421R	54342.....	826R	62521.....	416	67090.....	421-491	90252.....	334-15R	99580.....	PMV0099PT
52183.....	421A	54342-3.....	M826R	62521-3.....	M416	67090-3.....	B421-491	90302.....	110-15R	99593.....	425S-21
52183-5.....	421A	54343.....	826A-MV	62691.....	826C-7	67090-5.....	421-491	90303.....	110-15A	99593-3.....	425S-21
52193.....	352A	54362.....	816R	62691-3.....	M826C-7	68130.....	413-07	90762.....	V410-15R	99595.....	410-21
52193-3.....	M352A	54363.....	817A-9	62751.....	821C-7	68170.....	411-07	90922.....	124-15R	99595-3.....	410-21
52202.....	450KR	54562.....	817R-7	62751-3.....	M821C-7	68420.....	B5425Y	90923.....	124-15A	BZ101-5.....	921-MV
52203.....	450KA	54572.....	818R-7	62791.....	818C-7	68540-5.....	V5425Y	90941-5.....	V701C	BZ111-5.....	912-MV
52253.....	M352KA	54573.....	1218R-9	62791-3.....	M818C-7	71152.....	459	90951-5.....	V705C	BZ201-5.....	910-MV
52302.....	440	54682.....	M880-PL3	63151-5.....	V503HF	71422.....	449	90971-5.....	VH550	BZ551-5.....	913-MV
52302-5.....	V440	54722.....	820R-7	63171-5.....	V503HT	73030.....	785	91042.....	130-25R	BZ601-5.....	904-MV
52312.....	440L	55223.....	313AA	63181-5.....	V504HF	73040.....	780	91043.....	130-25A	G1002.....	173R
52312-5.....	V440L	55223-5.....	V313AA	63451-4.....	505K	73040-5.....	V780	91112.....	55-15R	G1003.....	173A
52362.....	V456L	55280.....	V313-2RA	63531.....	M525	73080.....	785	91113.....	55-15A	G1032.....	163R
52372.....	V456	55290.....	337-2	63611.....	906-MV	73090.....	781	91122.....	56-15R	G1033.....	163A
52442.....	M444	55982.....	717R	63611-5.....	V906-MV	73160.....	786-102	91302.....	445-25	G1082.....	V72R
52452.....	M444L	55983.....	717A	63741.....	903-MV	73220.....	786-97	91380.....	150-181	G1092.....	163R
52482.....	V456	55992.....	717R	63741-5.....	906-MV	76032.....	V774R	91400.....	143-18	G1093.....	163A
52492.....	V456L	55993.....	717A	63751.....	V906-MV	76033.....	V774A	91400-3.....	B143-18	G1502.....	203R
52513.....	352A	56000.....	337-2	63821.....	711	76253.....	798A	91410.....	142-18	G1503.....	203A
52522.....	M413S	56020.....	V335-2	63821-5.....	V711	76263.....	798A	91482.....	420-15	G1902.....	161R
52572.....	421KR	60001.....	400	63861.....	921-MV	77473.....	764A	91572.....	134-15R	G1902-5.....	V161KR
52592-5.....	V423XR-4	60001-3.....	M400	63861-5.....	V921-MV	77483.....	V764MA	91573.....	134-15A	G1903.....	161A
52602.....	454	60011.....	436SX	63981.....	910-MV	77813.....	791A	91582.....	334-15R	G1903-5.....	V161KA
52770.....	429R	60011-5.....	V436SX	63981-5.....	V910-MV	77823.....	791MA	91583.....	334-15A	G2102.....	188R
52770-3.....	M429R	60081.....	M436B	64101.....	V408	77912.....	740R	91683.....	118-15A	G2103.....	188A
52772.....	426R	60101.....	438	64261-4.....	505K	77913.....	740A	91740.....	426-18	G3002.....	165R
52772-3.....	M426R	60101-3.....	M438	64371-5.....	V582-2	78033.....	798A	91740-3.....	B426-18	G3003.....	165A
52772-5.....	V426R	60101-5.....	V438	64401-5.....	V566-1	78093.....	762A	91961.....	B138-15C	G3092.....	166R
52773.....	426A	60121.....	400	64441.....	V408	78113.....	744A	91962.....	138-15R	G3093.....	166A
52782.....	426KR	60151.....	435	64930.....	507LU	78143.....	4153SA	91962-3.....	B138-15R	G4002.....	M417R-P
52892.....	421R	60151-5.....	V435	64931.....	507	78163.....	4155SA	91963.....	138-15A	G4002-5.....	V417KR
52892-3.....	M421R	60251.....	437	64931-5.....	V507	78200.....	778A	91963-3.....	B138-15A	G4003.....	M417TA-P
52892-5.....	V421R	60251-5.....	V437	64941.....	508	78333.....	M146ABS	91964.....	B138-15G	G4012.....	V417KR
52893.....	421A	60261.....	150C	65202.....	161KR	78343.....	M142ABS	91965.....	B138-15B	G4502.....	850R-1P
52893-5.....	421A	60261-3.....	M150C	65203.....	161KA	78343-3.....	M142ABS	92070.....	144-18	G4503.....	850A-1P
52902.....	442	60271.....	150W	65300-5.....	V547	78433.....	M198ABS	92120.....	146-18	G4602.....	38R-MV
52912.....	442L	60291.....	154C	65320-5.....	V941	78433-3.....	M198ABS	92120-3.....	B146-18	G4602-5.....	V38R
52922.....	431R	60291-3.....	M154C	65370-5.....	V540	78460.....	4153SA	92150.....	146-182	G4603.....	38A-MV
52922-3.....	M431R	60301.....	154C	65380-5.....	541	78460-5.....	P4153SA	92150-3.....	B146-182	G4603-5.....	V38A
52922-5.....	V426R	60381.....	290C-BT2	65440-5.....	V544	79053.....	751A	92420.....	421-18	G5053.....	121A
52923.....	426A	60460.....	150C / 150-14	65720-5.....	V955	87220.....	5407S	92420-3.....	B421-18	G5082.....	845
53000.....	337-2	60591.....	V369S	65730-5.....	V555	87250.....	5407S	92432.....	107-15R	G5082-5.....	V845
53012.....	M431KR	60671.....	153C-BT2	65880-5.....	V941	87860.....	5407S	92433.....	107-15A	G5092.....	845L
53012-5.....	V426KR	61091.....	389S	66812.....	431-491	90011.....	414-15C	92510.....	424-09	G5092-5.....	V845L
53020.....	V335-2	61091-5.....	389S	66843.....	421-491	90012.....	410-15R	92511.....	424-09	G5300.....	V338-2
53092.....	421KR	61171.....	V379S	66843-3.....	B421-491	90012-3.....	B410-15R	92512.....	424-09	G5530.....	V327L
53093.....	421KA	61261.....	M360	66850.....	162-491	90012-5.....	V410-15R	92773.....	117-25	G5540.....	V327R
53132.....	306R	61291.....	M360	66851.....	162-493	90013.....	410-15A	92792.....	440-15	G6002.....	821R-22
53133.....	306A	61491-5.....	V391C	66860.....	417-496	90052.....	119-15R	93400.....	127-181	G6002-5.....	V821R-22
53422.....	717R	61501.....	M434	66861.....	417-49	90053.....	119-15A	93402.....	127-18	G6003.....	821A-22
53532.....	M417R	61501-5.....	V434	66862.....	417-48	90122.....	134-15R	93552.....	424-09	G6121.....	298C
53552.....	817R-7	61611.....	V503HF	66930.....	160-491	90122-5.....	V134-15R	93552-3.....	424-09	G6121-5.....	V298C
53553.....	817A-7	61861.....	368	66930-3.....	B160-491	90123.....	134-15A	93750.....	142-09 / 143-18	G6151.....	290
53582.....	869R	62101.....	817C-7	66931.....	160-492	90123-5.....	V134-15A	93750-3.....	142-09 / 143-18	G6151-5.....	V290
53662.....	M441	62101-3.....	M817C-7	66932.....	160-493	90152.....	136-15R	93760.....	146-09 / 146-181		
53672.....	M441L	62151.....	M411SC	66981.....	153-49	90152-5.....	136-15R	93760-3.....	146-09 / 146-181		

ST  
TURN  
MARKER  
B-U/UTIL  
SPEC  
EMERG  
ECE  
MOUNT  
ELECT  
REFLECT  
ACCY  
MERCH  
TECH

## Truck-Lite

TRUCK-LITE .....	PETERSON	TRUCK-LITE .....	PETERSON	TRUCK-LITE .....	PETERSON	TRUCK-LITE .....	PETERSON	TRUCK-LITE .....	PETERSON
00790.....	150-09	1507.....	107WR	26331.....	M432	3075.....	166R	4053A.....	824A-7
00791.....	150-10	1507A.....	107WA	26335.....	400	3075A.....	166A	4058.....	826R-7
00793.....	B150-12	15200C.....	150W	26336.....	437	313A.....	V764MA	4058A.....	826A-7
00802.....	150-13	15200R.....	150R	26336-1.....	V437	32.....	B484R	4060C.....	826C-7
00809.....	150-092	15200Y.....	150A	26393C.....	M394C	32A.....	B484A	4063C.....	824C-7
1001.....	V110R	15205.....	153C-P	2660.....	V180R	33010C.....	291KC-BT2	40700.....	426-18
1001A.....	V110A	15208.....	150C	2660A.....	V180A	33050R.....	M181R-BT2	40720.....	426-09
10075R.....	197KR	15227.....	153C-BT2	26765Y.....	M118A	33050Y.....	M181A-BT2	40725.....	426-10
10075Y.....	197KA	15250R.....	153R	26765Y1.....	V118A	33060C.....	171KC-BT2	41.....	B472R
10079R.....	197KFR	15250Y.....	153A	26901R.....	135R	33065C.....	171KC-BT2	41A.....	B472A
10079Y.....	197KFA	15408.....	150-092	26902R.....	135R	33075R.....	M181R-BT2	42722.....	428-09
10086R.....	163KR-MV	15409.....	150-102	26902Y.....	135A	33075Y.....	M181A-BT2	43.....	B460R
10086Y.....	163KA-MV	15506R.....	V150KR	27270C.....	701C	33203R.....	M271R-BT3	43A.....	B460A
10133.....	176-12	15506Y.....	V150KA	27291C.....	701C-ECE-LHT	33203Y.....	M271A-BT3	434WD.....	V434
10202R.....	142R	155.....	136R	27450C.....	705C	33204R.....	M271R-BT3	44001Y.....	V417KTA
10202Y.....	142A	1555A.....	136A	2750.....	V338-2	33204Y.....	M271A-BT3	44002R.....	V817KR-36
10205R.....	143R	1560.....	203R	2751.....	V339R	33210C.....	M291C-BT2	44002R1.....	V817KR-36
10205Y.....	143A	1560A.....	203A	2751A.....	V339A	33250R.....	M171R-BT2	44003Y.....	817KA-9
10208R.....	143R	1570.....	V114R	2758.....	V327R	33250Y.....	M171A-BT2	44023Y.....	818KA-9
10208Y.....	143A	1570A.....	V114A	2759.....	V327L	33260C.....	M171C-BT2	44024Y.....	818KA-9
10212Y.....	M142ABS	15702.....	B150-181	27640C.....	702C	33265B.....	4741B	44026R.....	V418KR
10275R.....	197R	15728.....	150-091	27645C.....	703C	33265C.....	M171C-BT2	44027Y.....	V418KTA
10275Y.....	197A	15729.....	150-14	2803.....	V335-2	33265R.....	M171R	44030R.....	817KR-7
10276R.....	V72R	15730.....	150-141	282.....	576	33265Y.....	M171A	44032R.....	818KR-7
10279R.....	197FR	15745R.....	150-3R	283.....	577	33275R.....	M181R-BT2	44036R.....	818KR-7
10279Y.....	197FA	15905.....	153C-MV	286.....	579	33275Y.....	M181A-BT2	44040C.....	817KC-9
10286R.....	163R	172.....	570	30075R.....	199KR	33285R.....	177CR-BT2	44041C.....	817KC-9
10286Y.....	163A	173.....	571	30075Y.....	199KA	33285Y.....	177CA-BT2	44044C.....	818KC-9
10288R.....	163FR	182.....	573	30080R.....	199KFR	33700.....	B177-18	44045C.....	818KC-9
10288Y.....	163FA	183.....	574	30080Y.....	199KFA	33711.....	176-10	44071Y.....	817KA-9
10401.....	143-18K	19002R.....	154KR	30133.....	176-11	33715.....	176-13	44082R.....	V817KR-36
10404.....	142-18K	19002Y.....	154KA	30200C.....	M146C	33800.....	B176-09	44091Y.....	817KA-7
1050.....	162R	19006R.....	161KR	30200R.....	146R	33810.....	B176-09X	44092R.....	817KR-7
1050A.....	162A	19006Y.....	161KA	30200R1.....	V146R	3550.....	60R	44092Y.....	818KA-7
1052.....	162R	19200C.....	154C	30200Y.....	146A	3550A.....	60A	44094Y.....	817KA-7
1052A.....	162A	19200R.....	154R	30200Y1.....	V146A	35720.....	160-09	44095Y.....	817KA-7
1058.....	197R	19200Y.....	154A	30201R.....	M145R	37.....	465-4	44141C.....	817KC-9
1058A.....	197A	19206.....	154C	30201Y.....	M145A	3753.....	313R	44146C.....	818KC-9
1070.....	162FR	19250R.....	161R	30222R.....	M146SR	3755.....	313R	44180C.....	817KC-7
1070A.....	162FA	19250Y.....	161A	30222Y.....	M146SA	3755D.....	V313R	44181C.....	818KC-7
10700.....	143-18	1960.....	161R	30230Y.....	M146ABS	3812.....	337-2	44182C.....	818KC-7
10702.....	144-18	1960A.....	161A	30264Y.....	M199A	3850.....	313-2RA	44183C.....	817KC-7
10704.....	142-18	19680A.....	778A	30269Y.....	M199FA	3850AA.....	313AA	44184C.....	817KC-7
10708.....	B142-17	19720.....	B154-09	30275R.....	M199R	3863.....	V335-2	44201Y.....	817A-36
10715.....	7007S	19721.....	154-09K	30275Y.....	M199A	40002R.....	426KR	44202R.....	817R-36
10720.....	2594	19724.....	B154-092	30279R.....	M199FR	40002Y.....	426KA	44203Y.....	817A-9
10724.....	165-10	19726.....	154-11K	30279Y.....	M199FA	40004.....	415K	44206C.....	817C-9
10725.....	142-09	19729.....	B154-11	30285R.....	165R	40028R.....	M431KR	44211Y.....	817SA-1/-2
10728.....	165-10	19739.....	154-10K	30285Y.....	165A	40028Y.....	426KA	44213Y.....	818SA-1/-2
10729.....	143-092	19740.....	B154-11K-BT1	30288R.....	M165FR	40041Y.....	426KA	44221Y.....	818A-36
10731.....	B142-091	19748.....	B154-10	30288Y.....	M165FA	40042R.....	426KR	44222R.....	818R-36
10740.....	V7007	21251R.....	187R	30289R.....	M165FR	40044.....	415K	44223Y.....	818A-9
1075.....	V72R	21251Y.....	187A	30289Y.....	M165FA	40058R.....	M431KR	44224Y.....	818A-9
1211.....	138R	21256R.....	187R-MV	30401.....	146-18K	40202R.....	426R	44226R.....	818R-36
1211A.....	138A	21256Y.....	187A-MV	3050.....	164R	40202R1.....	V426R	44227Y.....	818A-36
1211W.....	M138C	21275R.....	187R	3050A.....	164A	40202Y.....	426A	44235C.....	818C-9
1213.....	138R	21275Y.....	187A	30503R.....	V146KR	40204.....	415	44236C.....	818C-9
1213A.....	138A	2150.....	188R	30503R1.....	V146KR	40206R.....	429R	44240C.....	818C-9
1222.....	108WR	2150A.....	188A	30503Y.....	V146KA	40222R.....	M424R	44253R.....	817R-9
1222A.....	108WA	22202Y.....	343A	30503Y1.....	V146KA	40233R.....	M424R	44266R.....	818R-9
1259.....	135R	262.....	554	3058.....	199R	40241Y.....	426A	44276Y.....	818A-9
1259A.....	135A	26250R.....	133R	3058A.....	199A	40242R.....	426R	44291Y.....	817A-7
1264.....	108WR	26250Y.....	133A	307A.....	764A	40244.....	415	44292Y.....	818A-7
1264A.....	108WA	263.....	557	3070.....	164FR	40247R.....	426R	44294Y.....	817A-7
1320A.....	V118A	26302G.....	M138G	3070A.....	164FA	40258R.....	M424R	44295Y.....	818A-7
14200R.....	127R	26311R.....	123R	30700.....	146-18	40259R.....	M424R	44302R.....	817R-7
14200Y.....	127A	26311Y.....	123A	30702.....	146-182	4027.....	445	44304C.....	800W-9
14700.....	127-181	26313R.....	M122R	30708.....	7005S	4027D.....	V445	44308C.....	817W-9
14701.....	127-18	26313Y.....	M122A	30713.....	V7005	40282R.....	431R	44322R.....	818R-7
15033R.....	V153KR	26315R.....	119R	30720.....	2593	40282Y.....	426A	44326R.....	818R-7
15033Y.....	V153KA	26315Y.....	119A	30721.....	146-09	4050.....	826R-7	44339C.....	818W-9
15043.....	153C-142	26330.....	435	30728.....	146-092	4050A.....	826A-7	44344C.....	818C-7
15056.....	153C-143	26330-1.....	V435	30729.....	B146-093	4053.....	824R-7	44346C.....	818C-7





## Truck-Lite (cont.)

TRUCK-LITE .....	PETERSON	TRUCK-LITE .....	PETERSON	TRUCK-LITE .....	PETERSON	TRUCK-LITE .....	PETERSON	TRUCK-LITE .....	PETERSON
44350R.....	M417R	60052R.....	823KR-7	66056R.....	823KR-7	8948.....	440-15	94932.....	421-491Y
44350C.....	817C-7	60056R.....	823KR-7	66082R.....	823KR-7	900.....	500	94992.....	421-49
44351R.....	M417R-P	60061R.....	820KR-7	66085R.....	820KR-7	9004.....	110-15R	94993.....	421-491
44362R.....	M418R	60062R.....	823KR-7	66205C.....	820KC-7	9004A.....	110-15A	95220.....	417-49
44363R.....	M418R-P	60072Y.....	823KA-10	66206C.....	M823CTL-7	9004G.....	110-15G	95399.....	817-49Y
44438C.....	V379S	60074Y.....	820KA-10	66250R.....	820R-7	9004W.....	110-15C	95424.....	B417-492
44701.....	V7009	60075Y.....	820KA-10	66252R.....	823RTL-7	9007.....	138-15R	96830.....	701-491
44701-1.....	V7009	60082Y.....	423QA-P	66256R.....	823RTL-7	9007A.....	138-15A	97005.....	160-492
44705.....	7009S	60083R.....	421KR	66882R.....	823RTL-7	9007B.....	B138-15B	97159.....	5407P
44871Y.....	817A-9	60085R.....	820KR	66885R.....	820KR-7	9007G.....	B138-15G	97388.....	PMV0300T
44877Y.....	818A-9	60092C.....	416K	70311.....	313-2RA	9007W.....	B138-15C	97611.....	605
44878Y.....	818A-9	60094Y.....	820KA-10	70330R.....	313R	9016.....	334-15R	97618.....	654X
44881Y.....	817A-36	60096Y.....	823KA-10	7038.....	V600	9016A.....	334-15A	97619.....	654
44882R.....	817R-36	60097Y.....	823KA-10	7039.....	V603	9016B.....	334-15B	97627.....	615
44883R.....	818R-36	60201R.....	421R	7048.....	V602	9041.....	420-15	97659.....	B835
44887Y.....	818A-36	60201Y.....	421A	7268.....	B835	9049.....	445-25	97681.....	810
44888Y.....	818A-36	60202R.....	421R	7269.....	836	9057.....	V2549-15R	97802.....	605
44953R.....	M418R	60202R1.....	V421R	7618.....	598	9057A.....	V2549-15A	97803.....	608X
44954R.....	M418R-P	60202Y.....	M421A	7619.....	805	9093.....	134-15R	97804.....	608
44959R.....	M417R	60215Y.....	352A	797.....	459	9093A.....	134-15A	97805.....	832
44960R.....	M417R-P	60250R.....	820R-7	7973D.....	650	9102.....	411-07	97806.....	616W
44982R.....	817R-7	60252R.....	823RTL-7	798.....	449	91241Y.....	717A	97811.....	616
44983R.....	818R-7	60253R.....	820R-10	80162C.....	368	91242R.....	717R	97812.....	617X
44986R.....	818R-7	60255Y.....	820A-10	80164C.....	M368-BT2	91243Y.....	717A	97814.....	608XO
44990C.....	817C-7	60256R.....	823RTL-7	80253C.....	M360	91244R.....	717R	97819.....	655X
44991C.....	818C-7	60260R.....	820R-7	80255C.....	M365	91370Y.....	717A-PKD	97820.....	655
44992C.....	818C-7	60264R.....	820R-10	80302R1.....	425S	92522Y.....	760A	97822.....	617
45.....	481R	60266R.....	823RTL-7	80304.....	M411C	92523Y.....	760MA	97852.....	821
45A.....	481A	60272Y.....	823A-22	80334R.....	425	92524Y.....	761A	97860.....	615
45001R.....	M450R	60275Y.....	820A-22	80335R.....	425S	92525Y.....	761MA	97944.....	PM-103T
45002Y.....	450KR	60276Y.....	823A-22	80342.....	M411C	92534Y.....	744A	97960.....	46
45002Y.....	450KA	60280Y.....	820QA	80342-3.....	M411C	92539Y.....	769-2MA	97980.....	507LU
45202R.....	M450R	60282Y.....	823QA	80344.....	M411SC	92560.....	744A	98003R.....	B487R
45204.....	415	60283R.....	421R	80345.....	M411SC	92864Y.....	798A	98003R1.....	V487R
45207R.....	M450R	60283Y.....	421A	80355.....	M395C	92868Y.....	778A	98003Y.....	B487A
45251Y.....	850A-1P	60284C.....	416	80360.....	507	92872Y.....	P4156SA	98003Y1.....	V487A
45258R.....	850R-1P	60286Y.....	823QA	80360-1.....	V507	92878.....	B106-09	98006R.....	476R
45263Y.....	850A-1P	60290Y.....	820A-10	80361.....	507	92900.....	780	98006Y.....	476A
4550.....	850R-1P	60291Y.....	M823ATL-10	80364.....	M408	92900-1.....	V780	98013.....	PM-103T
4558.....	850R-1P	60292Y.....	M823ATL-10	80378.....	M507S	92901.....	780	98031R.....	B479R
4560C.....	850C-1P	60315Y.....	356A	80438.....	508	92902.....	781	98031Y.....	B479A
45700.....	450-18	60317Y.....	356AF	80461R.....	428	92916.....	786-97	98101.....	465-2
47.....	B475R	60354C.....	820C-7	80462R.....	428S	92918.....	786-102	98111.....	468-1C
47A.....	B475A	60356R.....	822R-7	80490.....	M396C	92924.....	782	98126.....	467-1
50.....	45-171	60360R.....	820SR-1/2	80525.....	V566-1	92925.....	19-41	98127.....	465-1
5050DK.....	V941	60360Y.....	820SA-1/2	80560.....	VH549	9342.....	107-15R	98136.....	465K
5055D.....	V840	60366Y.....	823SA-1/2	80571.....	VH550	9342A.....	107-15A	98137.....	467-4K
5056D.....	V840L	6050.....	821R-7	80594.....	V520-41	9371.....	126-15R	98165.....	469-1
5070.....	845L	6050A.....	821A-7	80720.....	440-09	9371A.....	126-15A	98168.....	469-1
5071.....	845	6053.....	822R-7	80888.....	505K	9371W.....	126-15C	98175R.....	490R
50868.....	P373	6053A.....	822A-7	81240.....	911-MV	9372.....	306-25R	98175Y.....	490A
50869.....	P411	60552R.....	M881-7	81250.....	921-MV	9372A.....	306-25A	98176R.....	489R
50878.....	P374	60553R.....	M881-7	81260.....	907	9373W.....	306-25C	98176Y.....	489A
50887.....	5406P	60557R.....	M880-7	81261.....	M908	9380SW.....	M389S	99001R.....	102-15R
50896.....	5407S	6058.....	821R-7	81300R.....	425	94237.....	160-49	99001Y.....	102-15A
52.....	B477R	6058A.....	821A-7	81360.....	911-MV	94609.....	160-49	99007C.....	414-15C
52A.....	B477A	6060C.....	821C-7	81380.....	921-MV	94706.....	417-491	99007R.....	410-15R
528.....	M456L	6063C.....	822C-7	8140.....	912-MV	94707.....	417-49	99007Y.....	410-15A
529.....	M456	60700.....	421-18	8150.....	921-MV	94718.....	160-491	99008R.....	410-25R
530DK.....	V547	60703.....	V7011	81510.....	910-MV	94727.....	153-49	99008Y.....	410-25A
533DK.....	V540	60719.....	7011S	81520.....	910-MV	94729.....	153-49	99009R.....	338-15R
534D.....	V440L	60720.....	421-09	8155.....	904-MV	94743.....	B431-492	99009Y.....	338-15A
535D.....	V440	60872Y.....	823A-22	81560.....	VH549	94759.....	417-48	99039R.....	110-15R
54.....	B480R	60885R.....	820R-7	8160.....	910-MV	94768.....	417-493	99039Y.....	110-15A
54A.....	B480A	60891Y.....	820A-22	8170.....	910-MV	94769.....	417-491Y	99041R.....	136-15R
549SWD.....	V391C	60892Y.....	820A-10	8192.....	913-MV	94789.....	417-481	99041Y.....	136-15A
60001R.....	421KR	610W.....	V503HF	8933.....	108-15R	94902.....	142-49	99066Y.....	117-25A
60001Y.....	421KA	613W.....	M525	8933A.....	108-15A	94909.....	B142-51	99067Y.....	118-15A
60002R.....	421KR	620W.....	507	8935W.....	389-15C	94916.....	B142-50	99090R.....	310-15R
60002R1.....	V421KR	627WD.....	V504HT	8937.....	136-15R	94919.....	142-49	99090Y.....	310-15A
60004C.....	416K	629WD.....	V504HF	8937A.....	136-15A	94924.....	162-49		
60015Y.....	M352KA	66050R.....	820KR-7	8947.....	55-15R	94925.....	431-49		
60050R.....	820KR	66052R.....	823KR-7	8947A.....	55-15A	94926.....	431-491		

ST  
TURN  
MARKER  
B-U/UTIL  
SPEC  
EMERG  
ECE  
MOUNT  
ELECT  
REFLECT  
ACCY  
MERCH  
TECH

## LED Limited Lifetime Warranty

LED lights manufactured by Peterson Manufacturing Company ("the manufacturer") and sold under the PM LED, LumenX®, Great White® and Piranha® brands are warranted to the original purchaser against defects in material and/or workmanship for the life of the product.

This Limited Lifetime Warranty is not transferable and applies only to the original installation of the product for as long as the original consumer owns the vehicle (lifetime). This warranty is subject to Conditions and Exclusions as noted below.

## Peterson®/Defender® LED 10-Year Limited Corrosion Warranty

PM LED® and LumenX® Brand LED lights manufactured by Peterson Manufacturing Company ("the manufacturer") and installed as a component part of the Peterson®/Maxi-Seal® Defender® brand Harness and Lighting System are warranted to the original purchaser against corrosion damage caused by the failure of the light or wiring

harness for a period of ten (10) years from the date of shipment. This Limited Warranty is not transferable and applies only to the original installation of the product.

This warranty is subject to Conditions and Exclusions as noted below.

## LED Three-Year Limited Warranty

LED lights manufactured by Peterson Manufacturing Company ("the manufacturer") that are listed herein are warranted to the original purchaser against defects in material and/or workmanship for a period of three (3) years from the date of shipment:

- LED headlights
- Great White® LED work lights

- Great White® LED strip lights
- Non-LumenX strobe beacons
- 215 Series clearance/marker lights
- Tunnel Lights™
- Nightwatcher® LED bar lights

This warranty is subject to Conditions and Exclusions as noted below.

## One-Year Limited Warranty

Incandescent, halogen and xenon lights and related accessories manufactured by Peterson Manufacturing Company ("the manufacturer") are warranted to the original purchaser against defects

in material and/or workmanship for one (1) year from the date of shipment.

This warranty is subject to Conditions and Exclusions as noted below.

## Conditions & Exclusions

### Conditions

Warranty claims require examination of the unserviceable part(s) by the manufacturer or an expressly designated agent. Refund, acceptance, return, or exchange of unserviceable parts by other parties, including the manufacturer's dealers and/or resellers, does not constitute a determination on behalf of the manufacturer that such part is deemed warrantable.

This warranty allows only for repair or replacement of the defective part, or refund of the purchase price, at the sole discretion of the manufacturer. The manufacturer makes no warranty regarding the fitness of its products for any particular purpose. The manufacturer is not liable for other incidental or consequential damages.

In no circumstances shall this warranty be extended to third parties except those performing as, or on behalf of, the manufacturer's authorized distributors.

Any implied warranties are limited to the specified warranty period.

### Exclusions

Any of the above warranties shall be null and void if any one of or combination of these exclusions apply:

- Failure to install, operate, and maintain the product in accordance with the manufacturer's recommendations and standard industry practices.
- The product is damaged due to accident, abuse, misuse, improper installation, unauthorized modification, or exposure to incompatible cleaners or solvents.
- Product failure is caused by the defect or malfunction of equipment or component(s) from a source other than the manufacturer.
- Product failure is caused by severe applications including (but not limited to) buses, off-road, and construction vehicles.
- Product failure is caused by corrosive chemicals including acid washes and highway snow and ice chemicals.
- Product failure is caused by connector failure and/or water penetration due to (but not limited to) cracked housing, cracked lens, wire wicking, or corrosion.

This warranty gives you specific legal rights. You may also have other rights that vary by state and country. Some jurisdictions do not allow limitations on the duration of implied warranties. Therefore, some of the above limitations may not apply to you.

# PART NUMBER INDEX

# TECHNICAL & REFERENCE INFO

## NEW PART NUMBERS HIGHLIGHTED IN YELLOW

H1/55W ..... 249	M106A ..... 77	124R ..... 82	M138G ..... 85	150-092 ..... 175
H3-70W-24V ..... 248	M106R ..... 77	M124R ..... 82	138R ..... 85	150-095 ..... 176
D3 ..... 259	M107-3A ..... 93	125-15A ..... 252	M138R ..... 85	B150-095 ..... 176
D4 ..... 259	107-3R ..... 93	125-15R ..... 252	V138R ..... 85	150-102 ..... 175
D7 ..... 258	M107-3R ..... 93	M125A ..... 82	140-24 ..... 63, 86	150-141 ..... 176
D9 ..... 257	V107-3R ..... 93	M125R ..... 82	M140FA ..... 86	B150-141 ..... 176
OV10-72 ..... 259	107-15A ..... 251	126-25A ..... 252	M140FR ..... 86	B150-141B ..... 191
D10 ..... 257	B107-15A ..... 251	126-25C ..... 252	142-09 ..... 171	B150-142 ..... 177
D11 ..... 258	V107-15A ..... 251	126-25R ..... 252	B142-17 ..... 172	B150-143 ..... 177
D12 ..... 259	107-15B ..... 251	M126A ..... 82	142-18 ..... 172	B150-181 ..... 176
D13 ..... 258	107-15R ..... 251	V126A ..... 82	B142-18 ..... 172	B150-491 ..... 200
STU15AM-77 ..... 249	B107-15R ..... 251	M126C ..... 108	142-18K ..... 172	B150-493 ..... 200
D15-RV ..... 258	V107-15R ..... 251	M126R ..... 82	142-49 ..... 199	150A ..... 88
D16 ..... 257	107WA ..... 78	V126R ..... 82	B142-49 ..... 199	M150A ..... 88
D17 ..... 257	M107WA ..... 78	127-18 ..... 171	B142-50 ..... 199	V150A ..... 88
19-41 ..... 216	V107WA ..... 78	B127-18 ..... 171	B142-51 ..... 199	150C ..... 109
D20-4 ..... 259	V107WB ..... 78	127A ..... 83	B142-091 ..... 171	M150C ..... 109
D20-6 ..... 259	107WR ..... 78	M127A ..... 83	142A ..... 86	V150C ..... 109
D20-12 ..... 259	M107WR ..... 78	V127KA ..... 83	M142A ..... 86	V150KA ..... 88
D21-02 ..... 258	V107WR ..... 78	V127KR ..... 83	V142A ..... 86	150KC ..... 109
D21 ..... 258	108-15A ..... 251	127R ..... 83	M142ABS ..... 86	V150KR ..... 88
BB-22 ..... 148	B108-15A ..... 251	M127R ..... 83	142KA ..... 86	150R ..... 88
D22-L ..... 259	V108-15A ..... 251	V128A ..... 83	V142KA ..... 86	M150R ..... 88
D22-M ..... 259	108-15R ..... 251	V128R ..... 83	142KR ..... 86	V150R ..... 88
D22-S ..... 259	B108-15R ..... 251	M129A ..... 56	V142KR ..... 86	150W ..... 109
D24 ..... 257	V108-15R ..... 251	129KA ..... 56	142R ..... 86	M150W ..... 109
D25 ..... 258	108-151A ..... 251	129KR ..... 56	M142R ..... 86	V150W ..... 109
D27 ..... 258	B108-151A ..... 251	M129R ..... 56	V142R ..... 86	M151-3RL ..... 93
D28 ..... 257	108-151R ..... 251	130-25A ..... 252	B143-17 ..... 173	V151-3RL ..... 93
D29 ..... 257	B108-151R ..... 251	130-25R ..... 252	143-18 ..... 172	151A ..... 88
D31 ..... 257	108WA ..... 78	130A ..... 84	B143-18 ..... 172	M151A ..... 88
V35A-BT2 ..... 54	M108WA ..... 78	M130A ..... 84	143-18K ..... 172	151R ..... 88
35A-MV ..... 54	V108WA ..... 78	130R ..... 84	143-092 ..... 173	M151R ..... 88
M35A-MV ..... 54	108WR ..... 78	M130R ..... 84	143A ..... 87	152-49 ..... 200
35A-MV-BT2 ..... 54	M108WR ..... 78	M132A ..... 83	M143A ..... 87	B152-49 ..... 200
M35A-MV-BT2 ..... 54	V108WR ..... 78	V132A ..... 83	V143A ..... 87	152A ..... 89
V35R-BT2 ..... 54	109-25A ..... 251	M132R ..... 83	M143FA ..... 87	M152A ..... 89
35R-MV ..... 54	V109A ..... 77	V132R ..... 83	M143FR ..... 87	M152BKA ..... 89
M35R-MV ..... 54	110-15A ..... 251	B133-10 ..... 171	143R ..... 87	M152BKR ..... 89
35R-MV-BT2 ..... 54	V110-15A ..... 251	133A ..... 56	M143R ..... 87	152R ..... 89
M35R-MV-BT2 ..... 54	110-15B ..... 251	M133A ..... 56	V143R ..... 87	M152R ..... 89
V38A ..... 54	110-15C ..... 251	133R ..... 56	144-18 ..... 172	153-49 ..... 200
38A-MV ..... 54	110-15G ..... 251	M133R ..... 56	B144-18 ..... 172	B153-49 ..... 200
M38A-MV ..... 54	110-15R ..... 251	V133XA ..... 56	146-09 ..... 174	B153-181 ..... 176
38A-MV-BT2 ..... 54	V110-15R ..... 251	V133XR ..... 56	B146-09 ..... 174	B153-492 ..... 200
M38A-MV-BT2 ..... 54	M110A ..... 79	134-15A ..... 252	146-18 ..... 173	153A ..... 55
V38R ..... 54	V110A ..... 79	B134-15A ..... 252	B146-18 ..... 173	M153A ..... 55
38R-MV ..... 54	M110R ..... 79	V134-15A ..... 252	146-18K ..... 173	153C-142 ..... 103
M38R-MV ..... 54	V110R ..... 79	134-15R ..... 252	B146-49 ..... 199	153C-BT2 ..... 103
38R-MV-BT2 ..... 54	V112A ..... 79	B134-15R ..... 252	146-092 ..... 173	M153C-BT2 ..... 103
M38R-MV-BT2 ..... 54	114-15A ..... 251	V134-15R ..... 252	B146-093 ..... 174	M153C-JAMP ..... 103
45-171 ..... 194	114-15R ..... 251	135-951 ..... 199	146-181 ..... 174	153C-MV ..... 103
45 ..... 194	M114A ..... 79	M153 ..... 85	B146-181 ..... 174	M153C-MV ..... 103
B45 ..... 194	V114A ..... 79	M135A ..... 85	146-182 ..... 173	M153C-MV-P ..... 103
46 ..... 194	M114R ..... 79	V135A ..... 85	B146-182 ..... 173	M153C-MV-PKD ..... 103
B46 ..... 194	V114R ..... 79	135R ..... 85	146A ..... 87	153C-P ..... 103
55-15A ..... 251	M116A ..... 80	M135R ..... 85	M146A ..... 87	M153C-P ..... 103
55-15R ..... 251	117-25 ..... 251	V135R ..... 85	V146A ..... 87	153CTP-BT3 ..... 102
56-15R ..... 251	118-15A ..... 251	136-3R ..... 93	M146ABS ..... 87	V153CTP-BT3 ..... 102
60A-MV ..... 55	M118A ..... 80	136-15A ..... 252	146C ..... 108	V153KA ..... 55
M60A-MV ..... 55	V118A ..... 80	136-15R ..... 252	M146C ..... 108	V153KC-MV ..... 103
60R-MV ..... 55	V118KA ..... 80	136A ..... 84	M146KA ..... 87	V153KR ..... 55
M60R-MV ..... 55	119-15A ..... 252	M136A ..... 84	V146KA ..... 87	153R ..... 55
B62 ..... 248	119-15R ..... 252	V136A ..... 84	M146KR ..... 87	M153R ..... 55
V72R ..... 57	119A ..... 80	136R ..... 84	V146KR ..... 87	B154-09 ..... 177
L2-77 ..... 249	M119A ..... 80	M136R ..... 84	146R ..... 87	154-09K ..... 177
L3-77 ..... 249	V119R ..... 80	V136R ..... 84	M146R ..... 87	B154-10 ..... 177
L7-77 ..... 249	M119R ..... 80	M137A ..... 84	V146R ..... 87	154-10K ..... 177
L2X-77 ..... 249	121A ..... 56	M137R ..... 84	M146SA ..... 87	B154-11 ..... 177
100-15A ..... 251	M121A ..... 56	138-15A ..... 252	M146SR ..... 87	154-11K ..... 177
B100-15A ..... 251	M122A ..... 81	B138-15A ..... 252	150-3R ..... 93	B154-11K ..... 177
100-15R ..... 251	M122R ..... 81	V138-15A ..... 252	M150-3R ..... 93	B154-11K-BT1 ..... 177
B100-15R ..... 251	M122XA ..... 81	B138-15B ..... 252	150-09 ..... 175	B154-092 ..... 177
102-15A ..... 251	V122XA ..... 81	B138-15C ..... 252	150-10 ..... 175	154A ..... 90
102-15R ..... 251	M122XR ..... 81	B138-15G ..... 252	B150-12 ..... 175	M154A ..... 90
M102A ..... 77	V222XR ..... 81	138-15R ..... 252	150-13 ..... 175	V154A ..... 90
V102A ..... 77	123A ..... 81	B138-15R ..... 252	150-14 ..... 176	154A-R ..... 89
M102R ..... 77	123R ..... 81	V138-15R ..... 252	B150-14 ..... 176	M154A-R ..... 89
V102R ..... 77	124-15A ..... 252	138A ..... 85	B150-18 ..... 176	154C ..... 109
PM-103T ..... 227	124-15R ..... 252	M138A ..... 85	150-49 ..... 200	M154C ..... 109
B106-09 ..... 171	124A ..... 82	V138A ..... 85	150-091 ..... 175	154KA ..... 90
V106-09 ..... 171	M124A ..... 82	M138C ..... 85, 108	B150-091 ..... 175	M154KA ..... 90

STT  
TURN  
MARKER  
B-U/UTIL  
SPEC  
EMERG  
ECE  
MOUNT  
ELECT  
REFLECT  
ACCY  
MERCH  
TECH

### NEW PART NUMBERS HIGHLIGHTED IN YELLOW

<b>154KR</b> ..... 90	M165FR-MV..... 67	M171W-MV-BT2..... 104	M179A..... 76	M192R..... 64
M154KR..... 90	<b>165KA-MV</b> ..... 67	<b>173A</b> ..... 62	<b>179R</b> ..... 76	M192SA..... 64
<b>154R</b> ..... 90	<b>165KR-MV</b> ..... 67	M173A..... 62	M179R..... 76	M192SR..... 64
M154R..... 90	<b>165R</b> ..... 67	<b>M173A-AMP</b> ..... 62	V180A..... 60	<b>193-492</b> ..... 202
V154R..... 90	M165R..... 67	<b>173R</b> ..... 62	V180R..... 60	B193-492..... 202
<b>155A</b> ..... 91	<b>165R-MV</b> ..... 67	M173R..... 62	M181A..... 73	<b>193A</b> ..... 65
M155A..... 91	M165R-MV..... 67	<b>M173R-AMP</b> ..... 62	M181A-BT2..... 73	M193A..... 65
<b>155R</b> ..... 91	M165SA..... 67	<b>175A</b> ..... 62	<b>V181A-BT2</b> ..... 73	<b>M193A-MV</b> ..... 65
M155R..... 91	M165SA-MV..... 67	M175A..... 62	M181A-MV..... 73	<b>193FA</b> ..... 65
<b>160-09</b> ..... 178	M165SR..... 67	M175FA..... 62	<b>M181A-MV-BT2</b> ..... 73	M193FA..... 65
<b>B160-09</b> ..... 178	M165SR-MV..... 67	M175FR..... 62	<b>181KA</b> ..... 73	M193FCA..... 65
<b>160-49</b> ..... 201	<b>166A</b> ..... 57	<b>175R</b> ..... 62	<b>181KA-BT2</b> ..... 73	M193FCR..... 65
B160-49..... 201	M166A..... 57	M175R..... 62	<b>181KA-MV</b> ..... 73	<b>193FR</b> ..... 65
<b>160-491</b> ..... 201	<b>V166A</b> ..... 57	B176-09..... 180	<b>181KR</b> ..... 73	M193FR..... 65
B160-491..... 201	<b>166R</b> ..... 57	B176-09X..... 180	<b>181KR-BT2</b> ..... 73	<b>193R</b> ..... 65
<b>160-492</b> ..... 201	M166R..... 57	<b>176-10</b> ..... 181	<b>181KR-MV</b> ..... 73	M193R..... 65
B160-492..... 201	<b>V166R</b> ..... 57	B176-10..... 181	M181R..... 73	<b>M193R-MV</b> ..... 65
<b>160-493</b> ..... 201	<b>168-09</b> ..... 178	<b>176-11</b> ..... 182	M181R-BT2..... 73	M193SA..... 65
<b>161A</b> ..... 57	B168-09..... 178	<b>176-12</b> ..... 182	<b>V181R-BT2</b> ..... 73	M193SCR..... 65
M161A..... 57	<b>B168-10</b> ..... 179	<b>176-13</b> ..... 181	M181R-MV..... 73	M193SR..... 65
M161A-R..... 57	<b>168-10K</b> ..... 179	B176-13..... 181	<b>M181R-MV-BT2</b> ..... 73	<b>194A</b> ..... 66
<b>161KA</b> ..... 57	<b>168-18</b> ..... 179	<b>176-14</b> ..... 182	<b>186-3R</b> ..... 92	M194A..... 66
V161KA..... 57	B168-18..... 179	B176-15..... 182	M186-3R..... 92	<b>194FA</b> ..... 66
<b>161KR</b> ..... 57	B168-092..... 179	<b>176-16</b> ..... 182	<b>B186-10</b> ..... 183	M194FA..... 66
V161KR..... 57	B168-092B..... 179	<b>B176-17</b> ..... 182	<b>B186-13</b> ..... 183	<b>194FR</b> ..... 66
<b>161R</b> ..... 57	<b>168-092K</b> ..... 179	B176-19..... 182	M186A..... 74	M194FR..... 66
M161R..... 57	B168-093..... 178	<b>176-092</b> ..... 181	<b>M186A-BT2</b> ..... 74	<b>194R</b> ..... 66
<b>162-49</b> ..... 201	B168-181..... 179	B176-092..... 181	<b>186CTP-BT3</b> ..... 102	M194R..... 66
B162-49..... 201	<b>B168-182</b> ..... 179	<b>176-093</b> ..... 181	M186CTP-BT3..... 102	<b>195A</b> ..... 67
<b>V162-49</b> ..... 201	<b>168A</b> ..... 58	B176-093..... 181	<b>186KA</b> ..... 74	M195A..... 67
B162-093..... 178	M168A..... 58	B176-491..... 202	<b>186KR</b> ..... 74	M195A-MV..... 67
<b>162-493</b> ..... 201	V168A..... 58	<b>B176-492</b> ..... 202	M186R..... 74	<b>195FA</b> ..... 67
B162-493..... 201	<b>168A-MV</b> ..... 58	B176-493..... 202	M186R-BT2..... 74	M195FA..... 67
<b>162A</b> ..... 64	M168A-MV..... 58	<b>B176-494</b> ..... 202	<b>M186W-BT2</b> ..... 104	<b>195FR</b> ..... 67
M162A..... 64	<b>168C</b> ..... 103	<b>176-496</b> ..... 202	<b>187A</b> ..... 61	M195FR..... 67
M162FA..... 64	M168C..... 103	M176A..... 72	M187A..... 61	<b>195R</b> ..... 67
M162FR..... 64	M168CA-BT2..... 58	<b>M176A-AMP</b> ..... 72	<b>M187A-BT2</b> ..... 61	M195R..... 67
V162KA..... 64	M168CR-BT2..... 58	M176A-BT2..... 72	<b>187A-MV</b> ..... 61	M195R-MV..... 67
V162KR..... 64	<b>168R</b> ..... 58	<b>176BKA</b> ..... 72	M187A-MV..... 61	<b>196A</b> ..... 68
<b>162R</b> ..... 64	M168R..... 58	<b>176BKR</b> ..... 72	<b>187R</b> ..... 61	M196A..... 68
M162R..... 64	V168R..... 58	<b>176KA</b> ..... 72	M187R..... 61	M196ABS..... 68
M162SA..... 64	<b>168R-MV</b> ..... 58	<b>176KA-ABS</b> ..... 72	M187R-BT2..... 61	V196KA..... 68
M162SR..... 64	M168R-MV..... 58	<b>176KA-AMP</b> ..... 72	<b>187R-MV</b> ..... 61	V196KR..... 68
<b>163A</b> ..... 65	V168XA..... 58	<b>176KR</b> ..... 72	M187R-MV..... 61	<b>196R</b> ..... 68
M163A..... 65	<b>168XA-MV</b> ..... 58	<b>176KR-AMP</b> ..... 72	<b>188A</b> ..... 61	M196R..... 68
<b>163A-MV</b> ..... 65	V168XR..... 58	M176R..... 72	M188A..... 61	<b>197A</b> ..... 68
M163A-MV..... 65	<b>168XR-MV</b> ..... 58	<b>M176R-AMP</b> ..... 72	<b>V188A</b> ..... 61	M197A..... 68
M163FA..... 65	M169-3A..... 92	M176R-BT2..... 72	<b>188R</b> ..... 61	M197A-AMP..... 68
<b>163FA-MV</b> ..... 65	M169-3ABT1..... 92	M176RGB..... 76	M188R..... 61	M197FA..... 68
M163FA-MV..... 65	<b>169-3R</b> ..... 92	<b>177-3R</b> ..... 92	<b>V188R</b> ..... 61	M197FA-AMP..... 68
M163FR..... 65	M169-3R..... 92	M177-3R..... 92	<b>189-24</b> ..... 63	M197FR..... 68
<b>163FR-MV</b> ..... 65	V169-3R..... 92	<b>B177-10</b> ..... 180	<b>189FA</b> ..... 63	M197FR-AMP..... 68
M163FR-MV..... 65	M169-3RBT1..... 92	B177-18..... 180	M189FA..... 63	<b>M197G-AMP</b> ..... 68
M163KA-MV..... 65	M169-3RBT2..... 92	<b>B177-182</b> ..... 181	M189FA-AMP..... 63	<b>197KA</b> ..... 68
<b>163KR-MV</b> ..... 65	B169-18..... 180	M177A..... 73	<b>M189FA-CLP</b> ..... 63	<b>197KFA</b> ..... 68
<b>163R</b> ..... 65	<b>169A</b> ..... 59	<b>M177A-AMP</b> ..... 73	<b>189FR</b> ..... 63	<b>197KFR</b> ..... 68
M163R..... 65	M169A..... 59	M177A-BT2..... 73	M189FR..... 63	<b>197KR</b> ..... 68
<b>163R-MV</b> ..... 65	V169KA..... 59	<b>M177CA-BT2</b> ..... 73	M189FR-AMP..... 63	<b>197R</b> ..... 68
M163R-MV..... 65	V169KR..... 59	M177CR-BT2..... 73	<b>M189FR-CLP</b> ..... 63	M197R..... 68
M163SA..... 65	<b>169R</b> ..... 59	M177R..... 73	<b>190FA</b> ..... 63	M197R-AMP..... 68
M163SR..... 65	M169R..... 59	<b>M177R-AMP</b> ..... 73	M190FA..... 63	<b>198A</b> ..... 69
<b>164A</b> ..... 66	M170A..... 59	M177R-BT2..... 73	M190FA-AMP..... 63	M198A..... 69
M164A..... 66	V170A..... 59	<b>178-10</b> ..... 182	<b>M190FA-CLP</b> ..... 63	M198ABS..... 69
M164FA..... 66	<b>M170A-BT1</b> ..... 59	B178-10..... 182	<b>190FR</b> ..... 63	V198KA..... 69
M164FR..... 66	M170R..... 59	M178A..... 60	M190FR..... 63	V198KR..... 69
V164KA..... 66	V170R..... 59	<b>V178A</b> ..... 60	M190FR-AMP..... 63	<b>198R</b> ..... 69
V164KR..... 66	<b>M170R-BT1</b> ..... 59	<b>178A-MV</b> ..... 60	<b>M190FR-CLP</b> ..... 63	M198R..... 69
<b>164R</b> ..... 66	M171A..... 72	M178A-MV..... 60	M191-3RL..... 92	M199A..... 69
M164R..... 66	V171A..... 72	M178A-MVC..... 60	V191-3RL..... 92	M199A-AMP..... 69
M164SA..... 66	M171A-BT2..... 72	M178CA-BT2..... 60	M191A..... 70	M199FA..... 69
M164SR..... 66	M171A-P..... 72	M178CR-BT2..... 60	M191R..... 70	M199FA-AMP..... 69
<b>165-10</b> ..... 178	M171C..... 104	M178R..... 60	<b>192-492</b> ..... 202	M199FR..... 69
B165-10..... 178	V171C..... 104	V178R..... 60	B192-492..... 202	M199FR-AMP..... 69
<b>165A</b> ..... 67	<b>M171C-BT2</b> ..... 104	<b>178R-MV</b> ..... 60	<b>B192-493</b> ..... 202	<b>199KA</b> ..... 69
M165A..... 67	<b>171KA</b> ..... 72	M178R-MV..... 60	<b>192A</b> ..... 64	<b>199KFA</b> ..... 69
<b>165A-MV</b> ..... 67	<b>171KC</b> ..... 104	<b>178W-MV</b> ..... 104	M192A..... 64	<b>199KFR</b> ..... 69
M165A-MV..... 67	<b>171KC-BT2</b> ..... 104	M178W-MV..... 104	<b>192ABS</b> ..... 64	<b>199KR</b> ..... 69
M165FA..... 67	<b>171KR</b> ..... 72	V178XA..... 60	<b>192FA</b> ..... 64	M199R..... 69
<b>165FA-MV</b> ..... 67	M171R..... 72	<b>178XA-MV</b> ..... 60	M192FA..... 64	M199R-AMP..... 69
M165FA-MV..... 67	V171R..... 72	V178XR..... 60	<b>192FR</b> ..... 64	<b>203A</b> ..... 70
M165FR..... 67	M171R-BT2..... 72	<b>178XR-MV</b> ..... 60	M192FR..... 64	M203A..... 70
<b>165FR-MV</b> ..... 67	M171R-P..... 72	<b>179A</b> ..... 76	<b>192R</b> ..... 64	<b>203C</b> ..... 106

# PART NUMBER INDEX

# TECHNICAL & REFERENCE INFO

## NEW PART NUMBERS HIGHLIGHTED IN YELLOW

M203C	106	M291C-BT236	107	350AF	46	383-25A	253	B417-492	204
V203C	106	291KC-BT2	107	M350AF	46	383-25C	253	417-493	207
203R	70	M296C	107	351A	46	384-15A	253	V417-493	207
M203R	70	M296C-PKD	107	M351A	46	384-15C	253	417-496	207
203W	106	M296XC	107	V351A	46	V384	120	B417-496	207
M203W	106	V296XC	107	351AF	46	V384S	120	V417KR	8
V203W	106	298C	107	M351AF	46	M385S	120	V417KTA	38
M215A	70	M298C	107	352A	50	V385S	120	M417R	8
V215A	70	V298C	107	M352A	50	388-09X	183	M417R-P	8
M215R	70	M298C-BT2	107	V352A	50	B388-09X	183	M417TA-P	38
V215R	70	306-25A	252	M352KA	50	388A	71	B418-10	185
M233A	75	306-25C	252	M353A	61	M388A	71	V418KR	8
M233CA	75	306-25R	252	M353R	61	388C	118	V418KTA	38
M233CR	75	306A	49	355A	47	M388C	118	M418R	8
M233FA	75	V306A	49	M355A	47	V388C	118	418R-4	15
M233FCA	75	306R	21	M355AF	47	388R	71	M418R-4	15
M233FCR	75	V306R	21	356A	47	M388R	71	M418R-P	8
M233FR	75	308-15BLK	252	M356A	47	388WB	118	M418TA-P	38
M233R	75	308-15R	252	356AF	47	M388WB	118	418WTA	41
M250W-BT2	106	308L	22, 52	M356AF	47	V388WB	118	419-25A	254
M253A	75	308L-PKD	22, 52	358-1	114	389-15C	253	419-25R	254
M253R	75	308R	22, 52	M358-1	114	389S	121	M419	26
253SA-1	141	308R-PKD	22, 52	358-2	114	M389S	121	420-15	254
253SA-2	141	309AA	52	M358-2	114	M390S	121	V420-15	254
253SW-1	141	309R	22	358-3	114	V390S	121	V420KR	9
253SW-2	141	310-15A	252	M358-3	114	391-25	253	420QA-P	45
M271A	72	313-2	21	M358-4	114	M391	121	421-09	186
M271A-AMP	72	M313-2	21	M358-1-BT2	114	V391C	121	421-18	186
M271A-BT3	72	V313-2	21	M358-2-BT2	114	392-25C	253	B421-18	186
271KA	72	313-2RA	51	M358-3-BT2	114	M393C	100	421-49	207
271KA-BT3	72	V313-2RA	51	M358-4-BT2	114	M394C	109	B421-49	207
271KR	72	313-15A	252	359-1	115	M395C	121	421-491	207
271KR-BT3	72	313-15BLK	252	M359-1	115	397C	118	B421-491	207
M271R	72	313-15R	252	359-2	115	M397C	118	421-491RS	208
M271R-AMP	72	313AA	51	M359-2	115	398-BT2	118	421-491Y	208
M271R-BT3	72	V313AA	51	359-3	115	M398-BT2	118	421A	49
M272A	76	313R	51	M359-3	115	M399-BT2	118	M421A	49
272KA	76	V313R	51	M359-4	115	400	110	M421HR	23
M274A	76	V316MA	146	B359-10	183	M400	110	421KA	49
274KA	76	V316MR	146	M359-1-BT2	115	M408	134	M421KA	49
274KR	76	318L	17	M359-2-BT2	115	V408	134	421KR	23
M274R	76	318L-AMP	17	M359-3-BT2	115	410-15A	253	M421KR	23
M277K	71	318L-P	17	M359-4-BT2	115	410-15B	253	V421KR	23
M277K-BT2	71	318R	17	M360-1	113	410-15R	253	421R	23
M277KL	71	318R-AMP	17	M360	113	B410-15R	253	M421R	23
M277KL-BT2	71	318R-P	17	M360-BT2	113	V410-15R	253	V421R	23
M286A	74	319AA	43	362-1	113	410-21	22, 24, 100	423-11	186
M286A-BT3	74	319R	17	M362-1	113	410-25R	253	B423-11	186
286KA	74	M320A	43	362-2	113	411-07	203	423A-4	44
286KA-BT3	74	M321A	43	M362-2	113	411-24	22, 24, 100	M423A-4	44
286KR	74	V327AA	42	M362-1-BT2	113	P411	210	V423KR	9
286KR-BT3	74	V327L	42	M362-2-BT2	113	M411C	100	423QA-P	45
M286R	74	V327R	42	363-1	113	M411SC	100	423R-4	15
M286R-BT3	74	334-15A	253	M363-1	113	M413-3	22	M423R-4	15
290-09	183	B334-15A	253	M363-1PKD	113	413-07	203	423W-4	119
290-091	183	334-15B	253	363-2	113	413	22	M423W-4	119
290	105	B334-15B	253	M363-2	113	M413	22	V423XR-4	15
M290	105	334-15R	253	M363-1-BT2	113	V413	22	424-09	185
V290	105	B334-15R	253	M363-2-BT2	113	M413S	23	M424R	24
290B-P	105	V335-2	52	M364-1	113	414-15C	253	425	24
M290B-P	105	M335-2-BT2	52	M364-1PKD	113	415-15R	254	M425	24
290C	105	337-2	53	M364-1-BT2	113	415	101	425S	24
M290C	105	V338-2	42	M365	113	M415	101	M425S	24
V290C	105	338-15A	253	M365-BT2	113	415K	101	425S-21	22, 23, 24, 100
290C-AMP	105	B338-15A	253	368	116	416	101	426-09	185
M290C-AMP	105	338-15R	253	M368	116	M416	101	426-10	184
290C-BT2	105	B338-15R	253	V368	116	416K	101	426-11	184
M290C-BT2	105	V339A	42	V369S	116	417-1	184	426-18	185
M290C-MFP	105	339A-BT2	42	M370	116	P417-1	184	B426-18	185
290C-MV	105	M339R	17	M371	117	417-2	184	426A	48
M290C-MV	105	V339R	17, 42	M371S	117	417-3	184	M426A	48
290C-SM	105	M339R-DEU	17	P373	210	417-48	204	426KA	48
M290C-SM	105	343-25A	253	P374	210	B417-48	204	426KR	25
290C-SM-BT2	105	343-241	50	375-15C	253	417-49	204	M426KR	25
M290C-SM-BT2	105	343A	50	V379S	117	B417-49	204	V426KR	25
M290C-SM-PKD	105	M343A	50	380-25C	253	417-481	204	426R	25
290-BT2	105	344-49	203	M380S	120	B417-481	204	M426R	25
M290-BT2	105	344A	53	M381	117	417-482	204	V426R	25
290-MV	105	M350A	46	M381X	117	417-491	204	426WTA	50
M290-MV	105	350A-P	46	V381X	117	B417-491	204	428-09	191
M291C-AMP	107	M350A-P	46	M382C	120	417-491MP	206	B428-09	191
M291C-BT2	107	M350A-PKD2	46	V382S	120	417-491Y	206	V428-09	191

STT  
TURN  
MARKER  
B-U/UTIL  
SPEC  
EMERG  
ECE  
MOUNT  
ELECT  
REFLECT  
ACCY  
MERCH  
TECH

**NEW PART NUMBERS HIGHLIGHTED IN YELLOW**

428.....26	V457.....30	V493KA.....232	700-15C.....121	780.....197
M428.....26	M457L.....30	V493KR.....232	701-83.....158	V780.....197
V428.....26	V457L.....30	500.....216	701-491.....209	781.....197
428S.....26	B457L-15.....254	V500.....216	701C.....122	V781.....197
M428S.....26	459-1.....239	M502HF.....134	M701C.....122	782.....197
V428S.....26	459.....239	V502HF.....134	V701C.....122	782-BT2.....197
429R.....25	B460A.....234	V502HT.....134	701C-ECE-LHT.....158	V783.....198
M429R.....25	B460R.....234	M503HF.....134	V701KC-2.....122	784.....198
431-49.....209	461B.....234	V503HF.....134	702C.....122	784-C.....198
B431-49.....209	461B-48.....234	V503HT.....134	V702C.....122	785.....198
V431-49.....209	461R.....234	V504HF.....135	703C.....122	786-97.....198
431-491.....209	461R-48.....234	V504HT.....135	V703C.....122	786-102.....198
B431-491.....209	463-1.....230	505K.....136	705C.....123	787A.....154
V431-491.....209	464-1.....230	507.....135	V705C.....123	788A.....155
B431-492.....209	464-2.....230	M507.....135	711.....123	789A.....154
M431C.....101	465-1.....230	V507.....135	V711.....123	789MA.....154
M431KA.....48	465-2.....230	507LU.....135	717A.....44	789R.....154
M431KC.....101	465-3.....230	M507S.....135	717C.....99	790A.....155
M431KR.....24	465-4.....230	M508.....135	717R.....16	790B.....155
431R.....24	465-4K.....231	V508.....135	740-09.....190	790C.....155
M431R.....24	465-5.....230	510-9.....188	740A.....146	790R.....155
M432.....112	465K.....231	B510-72.....221	740R.....146	791-25A.....255
V432.....112	467-1.....230	B511-72.....221	744A.....149	791A.....150
M434.....110	467-4K.....231	516S.....136	745A.....149	791MA.....150
V434.....110	468-1C.....230	M517S.....137	751-24K.....156	792C.....151
435.....110	469-1.....230	V520-09.....188	751A.....156	793A.....155
M435.....110	469-3.....230	V520-10.....137	752A.....157	794-09.....187
V435.....110	469.....230	V520-40.....215	752MA.....157	797A.....151
436-25.....254	470-1.....231	V520-41.....216	755-15A.....254	798A.....152
436.....111	B472A.....234	M525.....137	756-15A.....254	799A.....152
M436.....111	V472A.....234	V525S-2.....137	756-15B.....254	800W-9.....124
M436B.....111	B472R.....234	M526.....137	756-15R.....254	M800W-9.....124
M436B-P.....111	V472R.....234	V530.....136	756-21.....148	800WF-9.....124
436SX.....111	B474A.....234	M540.....32	756-23.....148	M800WF-9.....124
V436SX.....111	B474R.....234	V540.....32	756A.....148	805.....242
M437.....112	B475A.....235	541.....32	756A24.....148	807.....242
V437.....112	V475A.....235	V544.....33	756MA.....148	810.....243
438.....112	B475R.....235	V547.....33	756R24.....148	814R.....11
M438.....112	V475R.....235	VH549.....248	760-25A.....254	M814R.....11
V438.....112	476A.....235	VH550.....248	760-25C.....254	816R.....11
M439.....112	B476A.....235	554.....195	760A.....156	M816R.....11
440-09.....191	476R.....235	V554.....195	760MA.....156	817-09.....187
B440-09.....191	B476R.....235	V555.....139	761A.....156	B817-09.....187
V440-09.....191	477A.....235	557-2.....138	761MA.....156	817-10.....187
440-15.....254	B477A.....235	557.....195	762A.....149	B817-10.....187
V440-15.....254	477R.....235	V566-1.....138	763A.....148	817-48.....204
440.....28	B477R.....235	570.....195	764A.....150	B817-48.....204
M440.....28	B479A.....236	B570.....195	764A-2.....152	817-49.....205
V440.....28	B479R.....236	V570.....195	V764MA.....150	B817-49.....205
440L.....28	B480A.....236	571.....195	766-25A.....150, 152	B817-49L.....205
M440L.....28	V480A.....236	572.....195	V768A.....153	B817-49S.....205
V440L.....28	B480R.....236	573.....196	769-1A.....153	817-49Y.....208
M441.....28	V480R.....236	V573.....196	769-1B.....153	B817-481.....204
M441L.....28	481A.....236	574.....196	769-1C.....153	B817-482.....204
442.....27	B481A.....236	576.....196	769-1HA.....153	B817-491.....205
442L.....27	481R.....236	V576.....196	769-1R.....153	B817-492.....205
444-151R.....254	B481R.....236	577.....196	769-2MA.....154	817-497.....205
M444.....29	B483A.....237	579.....196	769-25A.....254	817-4996.....208
M444L.....29	V483A.....237	V582-2.....138	769-25B.....254	817-49288.....208
445-25.....254	B483R.....237	585-77.....249	769-25C.....254	817A-36.....38
445.....27	V483R.....237	V586-2.....138	769-25HA.....255	M817A-36.....38
V445.....27	B484A.....237	598.....242	769-25R.....254	817A-7.....34
449-1.....239	B484R.....237	609.....240	769A.....153	M817A-7.....34
449.....239	B486W.....231	V602.....240	769B.....153	817A-9.....35
450-18.....188	B487A.....237	V603.....240	769C.....153	M817A-9.....35
B450-18.....188	V487A.....237	605.....242	769MA.....153	817C-7.....94
450KA.....49	B487R.....237	608.....240	769R.....153	M817C-7.....94
450KR.....26	V487R.....237	608X.....240	771-15A.....255	817C-9.....95
M450R.....26	489A.....233	608XO.....241	771-15B.....255	M817C-9.....95
M452.....29	B489A.....233	609.....244	V771A.....147	817CR-2.....13
V452.....29	489R.....233	615.....245	V771B.....147	M817CR-2.....13
M452L.....29	B489R.....233	616.....245	V772A.....146	M817CR-3.....13
V452L.....29	490A.....233	616W.....245	V773A.....147	817CR-36.....14
454.....27	B490A.....233	617X.....245	774-15A.....255	M817CR-36.....14
M456-3P.....30	490R.....233	650.....242	774-15B.....147	817KA-7.....34
M456.....30	B490R.....233	654.....241	774-15R.....255	817KA-9.....35
V456.....30	491A.....233	654X.....241	V774A.....147	817KC-7.....94
M456L.....30	B491A.....233	655.....241	V774R.....147	817KC-9.....95
V456L.....30	491R.....233	655X.....241	778-48.....209	V817KCR-36.....14
M456L-3P.....30	B491R.....233	658X.....241	778A.....157	V817KR-36.....8
B457-15.....254	B492A.....233	667X.....243	779-1A.....157	817KR-7.....4
M457.....30	B492R.....233	668X.....241	779-40.....157	817KR-9.....5

# PART NUMBER INDEX

# TECHNICAL & REFERENCE INFO

## NEW PART NUMBERS HIGHLIGHTED IN YELLOW

<b>817R-36</b> ..... 8	<b>M820R-22</b> ..... 9	<b>823KA-10</b> ..... 37	<b>827R</b> ..... 12	<b>M867SA-1</b> ..... 144
<b>M817R-36</b> ..... 8	<b>820R-7</b> ..... 6	<b>823KA-7</b> ..... 36	<b>M827R</b> ..... 12	<b>867SA-2</b> ..... 144
<b>817R-7</b> ..... 4	<b>M820R-7</b> ..... 6	<b>823KC-10</b> ..... 97	<b>M829C-7</b> ..... 98	<b>M867SA-2</b> ..... 144
<b>M817R-7</b> ..... 4	<b>820SA-1</b> ..... 142	<b>823KC-7</b> ..... 96	<b>829R-7</b> ..... 12	<b>867SA-3</b> ..... 144
<b>817R-9</b> ..... 5	<b>820SA-10</b> ..... 140	<b>823KR-10</b> ..... 7	<b>M829R-7</b> ..... 12	<b>867SA-4</b> ..... 144
<b>M817R-9</b> ..... 5	<b>M820SA-10</b> ..... 140	<b>823KR-7</b> ..... 6	<b>830</b> ..... 244	<b>869R</b> ..... 14
<b>817SA-1</b> ..... 142	<b>820SA-2</b> ..... 142	<b>823QA</b> ..... 45	<b>832</b> ..... 243	<b>M869R</b> ..... 14
<b>817SA-2</b> ..... 142	<b>820SR-1</b> ..... 142	<b>823QCA</b> ..... 45	<b>B835</b> ..... 244	<b>870W</b> ..... 119
<b>817SA-9</b> ..... 140	<b>820SR-10</b> ..... 140	<b>823R-10</b> ..... 7	<b>836</b> ..... 244	<b>M870W</b> ..... 119
<b>M817SA-9</b> ..... 140	<b>M820SR-10</b> ..... 140	<b>M823R-10</b> ..... 7	<b>840</b> ..... 18	<b>M870W-BT2</b> ..... 119
<b>817SR-9</b> ..... 140	<b>820SR-2</b> ..... 142	<b>823R-22</b> ..... 9	<b>M840</b> ..... 18	<b>872W</b> ..... 119
<b>817SW-9</b> ..... 140	<b>820SW-10</b> ..... 140	<b>M823R-22</b> ..... 9	<b>V840</b> ..... 18	<b>M872W</b> ..... 119
<b>817TA-2C</b> ..... 40	<b>821</b> ..... 243	<b>823R-7</b> ..... 6	<b>840L</b> ..... 18	<b>M872W-BT2</b> ..... 119
<b>M817TA-2C</b> ..... 40	<b>821A-10</b> ..... 37	<b>M823R-7</b> ..... 6	<b>M840L</b> ..... 18	<b>M880-7</b> ..... 10
<b>817W-9</b> ..... 124	<b>M821A-10</b> ..... 37	<b>M823RTL-10</b> ..... 7	<b>V840L</b> ..... 18	<b>M880-7P</b> ..... 10
<b>M817W-9</b> ..... 124	<b>821A-22</b> ..... 39	<b>823RTL-7</b> ..... 6	<b>844-252</b> ..... 18, 255	<b>880-49</b> ..... 205
<b>817YA</b> ..... 41	<b>M821A-22</b> ..... 39	<b>M823RTL-7</b> ..... 6	<b>844-253</b> ..... 18, 255	<b>B880-49</b> ..... 205
<b>818A-36</b> ..... 38	<b>V821A-22</b> ..... 39	<b>823SA-1</b> ..... 142	<b>844</b> ..... 18	<b>B880-491</b> ..... 205
<b>M818A-36</b> ..... 38	<b>821A-7</b> ..... 36	<b>823SA-10</b> ..... 140	<b>M844</b> ..... 18	<b>B880-496</b> ..... 205
<b>818A-7</b> ..... 34	<b>M821A-7</b> ..... 36	<b>823SA-2</b> ..... 142	<b>V844</b> ..... 18	<b>880K-7</b> ..... 10
<b>M818A-7</b> ..... 34	<b>M821C-10</b> ..... 97	<b>823SR-10</b> ..... 140	<b>844L</b> ..... 18	<b>880K-7-MV</b> ..... 10
<b>818A-9</b> ..... 35	<b>M821C-10</b> ..... 97	<b>823SW-10</b> ..... 140	<b>M844L</b> ..... 18	<b>M880-7-MV</b> ..... 10
<b>M818A-9</b> ..... 35	<b>821C-7</b> ..... 96	<b>824A-7</b> ..... 34	<b>V844L</b> ..... 18	<b>M880-PL3</b> ..... 10
<b>818C-7</b> ..... 94	<b>M821C-7</b> ..... 96	<b>M824A-7</b> ..... 34	<b>M844-BT3</b> ..... 18	<b>M881-7</b> ..... 10
<b>M818C-7</b> ..... 94	<b>821KA-10</b> ..... 37	<b>824A-9</b> ..... 35	<b>845</b> ..... 19	<b>M881-7P</b> ..... 10
<b>818C-9</b> ..... 95	<b>V821KA-22</b> ..... 39	<b>M824A-9</b> ..... 35	<b>V845</b> ..... 19	<b>881K-7</b> ..... 10
<b>M818C-9</b> ..... 95	<b>821KA-7</b> ..... 36	<b>824A-MV</b> ..... 40	<b>845L</b> ..... 19	<b>881K-7-MV</b> ..... 10
<b>818CR-2</b> ..... 13	<b>V821KA-7</b> ..... 36	<b>M824A-MV</b> ..... 40	<b>V845L</b> ..... 19	<b>M881-7-MV</b> ..... 10
<b>M818CR-2</b> ..... 13	<b>821KC-10</b> ..... 97	<b>824C-7</b> ..... 94	<b>850-1</b> ..... 189	<b>M882-7</b> ..... 10
<b>818CR-36</b> ..... 14	<b>821KC-7</b> ..... 96	<b>M824C-7</b> ..... 94	<b>850-09</b> ..... 189	<b>M882-7P</b> ..... 10
<b>M818CR-36</b> ..... 14	<b>V821KC-7</b> ..... 96	<b>824C-9</b> ..... 95	<b>850-18</b> ..... 188	<b>882K-7</b> ..... 10
<b>818KA-7</b> ..... 34	<b>821KR-10</b> ..... 7	<b>M824C-9</b> ..... 95	<b>B850-18</b> ..... 188	<b>882K-7-MV</b> ..... 10
<b>818KA-9</b> ..... 35	<b>V821KR-22</b> ..... 9	<b>824C-MV</b> ..... 98	<b>850-092H</b> ..... 189	<b>M882-7-MV</b> ..... 10
<b>818KC-7</b> ..... 94	<b>821KR-7</b> ..... 6	<b>M824C-MV</b> ..... 98	<b>850-092V</b> ..... 189	<b>M883-7</b> ..... 10
<b>818KC-9</b> ..... 95	<b>V821KR-7</b> ..... 6	<b>824KA-7</b> ..... 34	<b>850-093H</b> ..... 189	<b>M883-7P</b> ..... 10
<b>818KR-7</b> ..... 4	<b>821R-10</b> ..... 7	<b>V824KA-7</b> ..... 34	<b>850-093V</b> ..... 189	<b>883K-7</b> ..... 10
<b>818KR-9</b> ..... 5	<b>M821R-10</b> ..... 7	<b>824KA-9</b> ..... 35	<b>850A</b> ..... 44, 167	<b>883K-7-MV</b> ..... 10
<b>818R-36</b> ..... 8	<b>821R-22</b> ..... 9	<b>824KC-7</b> ..... 94	<b>850A-1</b> ..... 44, 167	<b>M883-7-MV</b> ..... 10
<b>M818R-36</b> ..... 8	<b>M821R-22</b> ..... 9	<b>V824KC-7</b> ..... 94	<b>P850A-1</b> ..... 44, 167	<b>901-MV</b> ..... 124
<b>818R-7</b> ..... 4	<b>V821R-22</b> ..... 9	<b>824KC-9</b> ..... 95	<b>850A-1P</b> ..... 44, 167	<b>V901-MV</b> ..... 124
<b>M818R-7</b> ..... 4	<b>821R-7</b> ..... 6	<b>824KR-7</b> ..... 4	<b>850C</b> ..... 99, 168	<b>903-MV</b> ..... 125
<b>V818R-7</b> ..... 4	<b>M821R-7</b> ..... 6	<b>V824KR-7</b> ..... 4	<b>850C-1</b> ..... 99, 168	<b>903-MV-PKD</b> ..... 125
<b>818R-9</b> ..... 5	<b>M821SA-10</b> ..... 140	<b>824KR-9</b> ..... 5	<b>P850C-1</b> ..... 99, 168	<b>904-MV</b> ..... 125
<b>M818R-9</b> ..... 5	<b>822A-10</b> ..... 37	<b>824R</b> ..... 11	<b>850C-1P</b> ..... 99, 168	<b>V904-MV</b> ..... 125
<b>818SA-1</b> ..... 142	<b>M822A-10</b> ..... 37	<b>M824R</b> ..... 11	<b>850C-AMP</b> ..... 99, 168	<b>904-MV-BT2</b> ..... 125
<b>818SA-2</b> ..... 142	<b>822A-22</b> ..... 39	<b>824R-7</b> ..... 4	<b>850F-SW</b> ..... 167	<b>905-MV</b> ..... 126
<b>818SA-9</b> ..... 140	<b>M822A-22</b> ..... 39	<b>M824R-7</b> ..... 4	<b>850HC-1</b> ..... 99, 168	<b>M905-MV</b> ..... 126
<b>M818SA-9</b> ..... 140	<b>822A-7</b> ..... 36	<b>824R-9</b> ..... 5	<b>850R</b> ..... 16, 167	<b>V905-MV</b> ..... 126
<b>818SR-9</b> ..... 140	<b>M822A-7</b> ..... 36	<b>M824R-9</b> ..... 5	<b>850R-1</b> ..... 16, 167	<b>M905-MV-AMP</b> ..... 126
<b>818SW-9</b> ..... 140	<b>822C-10</b> ..... 97	<b>824R-MV</b> ..... 11	<b>P850R-1</b> ..... 16, 167	<b>M905-MV-BT2</b> ..... 126
<b>818TA-2C</b> ..... 40	<b>M822C-10</b> ..... 97	<b>M824R-MV</b> ..... 11	<b>850R-1P</b> ..... 16, 167	<b>906-MV</b> ..... 126
<b>M818TA-2C</b> ..... 40	<b>822C-7</b> ..... 96	<b>826A-7</b> ..... 34	<b>850SA</b> ..... 141	<b>M906-MV</b> ..... 126
<b>818W-9</b> ..... 124	<b>M822C-7</b> ..... 96	<b>M826A-7</b> ..... 34	<b>850SA-AMP</b> ..... 141	<b>V906-MV</b> ..... 126
<b>M818W-9</b> ..... 124	<b>822KA-10</b> ..... 37	<b>826A-9</b> ..... 35	<b>851A-R</b> ..... 168	<b>M906-MV-AMP</b> ..... 126
<b>818WTA</b> ..... 41	<b>822KA-7</b> ..... 36	<b>M826A-9</b> ..... 35	<b>851A-R-SW</b> ..... 168	<b>M906-MV-BT2</b> ..... 126
<b>818YA</b> ..... 41	<b>V822KA-7</b> ..... 36	<b>826A-MV</b> ..... 40	<b>P851A-R-SW</b> ..... 168	<b>907</b> ..... 127
<b>820-09</b> ..... 187	<b>822KC-10</b> ..... 97	<b>M826A-MV</b> ..... 40	<b>851F-C-SW</b> ..... 168	<b>M907-MV</b> ..... 127
<b>B820-09</b> ..... 187	<b>822KC-7</b> ..... 96	<b>826C-7</b> ..... 94	<b>856</b> ..... 19	<b>M908</b> ..... 127
<b>820-10</b> ..... 187	<b>V822KC-7</b> ..... 96	<b>M826C-7</b> ..... 94	<b>M856</b> ..... 19	<b>V908</b> ..... 127
<b>B820-10</b> ..... 187	<b>822KR-10</b> ..... 7	<b>826C-9</b> ..... 95	<b>V856</b> ..... 19	<b>M908S-MV-BT2</b> ..... 127
<b>820</b> ..... 243	<b>822KR-7</b> ..... 6	<b>M826C-9</b> ..... 95	<b>856L</b> ..... 19	<b>910M-MV</b> ..... 128
<b>820A-10</b> ..... 37	<b>V822KR-7</b> ..... 6	<b>826C-MV</b> ..... 98	<b>M856L</b> ..... 19	<b>V910M-MV</b> ..... 128
<b>M820A-10</b> ..... 37	<b>822R-10</b> ..... 7	<b>M826C-MV</b> ..... 98	<b>V856L</b> ..... 19	<b>910-MV</b> ..... 128
<b>820A-22</b> ..... 39	<b>M822R-10</b> ..... 7	<b>826KA-7</b> ..... 34	<b>860SA-1</b> ..... 144	<b>V910-MV</b> ..... 128
<b>M820A-22</b> ..... 39	<b>822R-22</b> ..... 9	<b>V826KA-7</b> ..... 34	<b>860SA-2</b> ..... 144	<b>910-MV-BT2</b> ..... 128
<b>820A-7</b> ..... 36	<b>M822R-22</b> ..... 9	<b>826KA-9</b> ..... 35	<b>860SA-3</b> ..... 144	<b>910-MV-PKD</b> ..... 128
<b>M820A-7</b> ..... 36	<b>822R-7</b> ..... 6	<b>826KC-7</b> ..... 94	<b>860SA-4</b> ..... 144	<b>911-MV</b> ..... 127
<b>820C-10</b> ..... 97	<b>M822R-7</b> ..... 6	<b>V826KC-7</b> ..... 94	<b>861SA-1</b> ..... 145	<b>911-MV-BT2</b> ..... 127
<b>M820C-10</b> ..... 97	<b>823A-10</b> ..... 37	<b>826KC-9</b> ..... 95	<b>861SA-2</b> ..... 145	<b>911-MV-PKD</b> ..... 127
<b>820C-7</b> ..... 96	<b>M823A-10</b> ..... 37	<b>826KR-7</b> ..... 4	<b>861SA-3</b> ..... 145	<b>912-MV</b> ..... 129
<b>M820C-7</b> ..... 96	<b>823A-22</b> ..... 39	<b>V826KR-7</b> ..... 4	<b>861SA-4</b> ..... 145	<b>V912-MV</b> ..... 129
<b>820KA-10</b> ..... 37	<b>M823A-22</b> ..... 39	<b>826KR-9</b> ..... 5	<b>866-486</b> ..... 206	<b>913MV-AMP</b> ..... 129
<b>820KA-7</b> ..... 36	<b>823A-7</b> ..... 36	<b>826R</b> ..... 11	<b>B866-486</b> ..... 206	<b>913MV-BT2</b> ..... 129
<b>820KC-10</b> ..... 97	<b>M823A-7</b> ..... 36	<b>M826R</b> ..... 11	<b>866FSA-1</b> ..... 145	<b>913-MV</b> ..... 129
<b>820KC-7</b> ..... 96	<b>M823ATL-10</b> ..... 37	<b>826R-7</b> ..... 4	<b>866FSA-2</b> ..... 145	<b>V913-MV</b> ..... 129
<b>820KR-10</b> ..... 7	<b>823C-10</b> ..... 97	<b>M826R-7</b> ..... 4	<b>866SA-1</b> ..... 145	<b>915-MV</b> ..... 130
<b>820KR-7</b> ..... 6	<b>M823C-10</b> ..... 97	<b>826R-9</b> ..... 5	<b>M866SA-1</b> ..... 145	<b>916S</b> ..... 130
<b>820KSA</b> ..... 140	<b>823C-7</b> ..... 96	<b>M826R-9</b> ..... 5	<b>866SA-2</b> ..... 145	<b>916S-JAMP</b> ..... 130
<b>820QA</b> ..... 45	<b>M823C-7</b> ..... 96	<b>826R-MV</b> ..... 11	<b>M866SA-2</b> ..... 145	<b>918S</b> ..... 130
<b>820R-10</b> ..... 7	<b>M823CTL-7</b> ..... 96	<b>M826R-MV</b> ..... 11	<b>866SA-3</b> ..... 145	<b>919-MV</b> ..... 130
<b>M820R-10</b> ..... 7	<b>823HSA-1</b> ..... 142	<b>8267FR</b> ..... 12	<b>866SA-4</b> ..... 145	<b>V919-MV</b> ..... 130
<b>820R-22</b> ..... 9	<b>823HSA-2</b> ..... 142	<b>827KR</b> ..... 12	<b>867SA-1</b> ..... 144	<b>920B-MV</b> ..... 131

STT  
TURN  
MARKER  
B-U/UTIL  
SPEC  
EMERG  
ECE  
MOUNT  
ELECT  
REFLECT  
ACCY  
MERCH  
TECH

**NEW PART NUMBERS HIGHLIGHTED IN YELLOW**

921-MV.....128	P1268W-MV.....170	5407S.....211	PMV1545KT.....222	PMV5522PT.....217
V921-MV.....128	1274R.....238	B5410.....212	PMV1546KT.....222	PMV5525PT.....220
921-MV-BT2.....128	1284A.....238	V5410.....212	PMV1560KT.....222	PMV5530PT.....220
928-MV.....131	1284R.....238	V5411.....212	PMV1560PT.....222	PMV5536PT.....218
930-MV.....132	1284W.....238	V5413.....212	PMV1560QT.....222	PMV5537PT.....218
931-MV.....132	1288.....159	5414.....212	PMV1575PT.....227	PMV5540PT.....218
V932-MV.....133	1288A.....159	V5414.....212	PMV1585KT.....221	PMV5543PT.....218
V933-MV.....133	1288B.....159	5415.....213	PMV1700KT.....223	PMV5544PT.....218
V934-MV.....133	1288C.....159	V5415.....213	PMV1700PT.....223	PMV5545PT.....218
V941.....20	1288F.....159	V5416.....213	PMV1700QT.....223	PMV5546PT.....218
V944.....20	1288R.....159	V5417.....213	PMV1705KT.....223	PMV5560PT.....219
V947.....20	1288TA.....159	B5425Y.....214	PMV1725KT.....223	PMV5561PT.....219
V955.....139	1290-09.....160	V5425Y.....214	PMV1749KT.....223	PMV5562PT.....219
1197SA.....141	1290-24.....160	PM5564PT.....220	PMV1755KT.....223	PMV5563PT.....219
1200-09H.....190	2217A-R.....164	5600-1.....215	PMV1755QT.....223	PMV5564PT.....220
1200-09X.....190	2217F-C.....164	P5600-1.....215	PMV1800KT.....223	PMV5570PT.....220
B1200-09X.....190	2218A-R.....164	5600.....215	PMV1800PT.....223	PMV5571PT.....219
1200A.....169	2218F-C.....164	P5600.....215	PMV1800QT.....223	PMV5572PT.....219
P1200A.....169	2219A-R.....164	5601.....215	PMV1804KT.....223	PMV5576PT.....219
1200A-AMP.....169	2219F-C.....164	5602.....215	PMV1805KT.....223	PMV5577PT.....219
1200C.....169	B2268-18.....179	5603.....215	PMV1805QT.....223	PMV5579PT.....217
1200C-AMP.....169	2268A-R-MV.....170	V7005.....192	PMV1806KT.....223	PMV5580PT.....220
1200R.....169	P2268A-R-MV.....170	7005S.....193	PMV1806QT.....223	PMV5583PT.....220
P1200R.....169	2268A-R-MV-BT2.....170	B7005S.....193	PMV1808KT.....223	PMV5584PT.....220
1200R-AMP.....169	P2268A-R-MV-BT2.....170	V7007.....192	PMV1808QT.....223	PMV5587PT.....220
1203A.....169	2290A-R.....160	7007S.....193	PMV1809KT.....223	PMV6110PT.....221
P1203A.....169	M2290A-R.....160	B7007S.....193	PMV1825KT.....224	PMV7029PT.....221
1203A-PKD.....169	2291A-R.....160	V7009.....192	PMV1855KT.....224	PMV7064PT.....226
1203C.....169	M2291A-R.....160	7009S.....193	PMV1855PT.....224	PMV7066PT.....226
P1203C.....169	2291F-C.....160	B7009S.....193	PMV1855QT.....224	PMV7067PT.....226
1203C-PKD.....169	M2291F-C.....160	V7009S.....193	PMV1856KT.....224	PMV7074PT.....226
1203R.....169	B2412.....214	V7011.....192	PMV1856QT.....224	PMV7076PT.....226
P1203R.....169	M2548A.....91	7011S.....193	PMV1858KT.....224	PMV7077PT.....226
1203R-PKD.....169	V2548A.....91	B7011S.....193	PMV1858QT.....224	PMV7120QT.....226
1217A-9.....161	M2548R.....91	7012.....193	PMV1864KT.....224	PMV8221PT.....226
1217A-R.....163	V2548R.....91	7013.....193	PMV1864PT.....224	PMV8226PT.....226
1217A-R-SW.....163	V2549-15A.....255	V25900-09.....191	PMV1865KT.....224	PMV81101PT.....226
1217C-9.....162	V2549-15R.....255	V25911-25.....255	PMV1865PT.....224	PMV81103PT.....226
1217F-9.....162	V2549A.....91	V25911.....31	PMV1865QT.....224	PMV81121PT.....226
1217F-C.....163	V2549R.....91	V25912-25.....255	PMV1900KT.....224	PMV81123PT.....226
1217G-R.....131	2578-1.....215	V25912.....31	PMV1900PT.....224	PMV81141PT.....226
1217KA-9.....161	2578.....215	V25913-25.....255	PMV1900QT.....224	PMV81142PT.....226
1217KC-9.....162	2593.....174	V25913.....31	PMV1905KT.....224	PMV81143PT.....226
1217KR-9.....161	2594.....174	V25914-25.....255	PMV1905QT.....224	PMV81145PT.....226
1217R-9.....161	2636A.....88	V25914.....31	PMV1906KT.....224	PMV81147PT.....226
1218A-9.....161	2636R.....88	V25921-25.....255	PMV1906PT.....224	PMV81161PT.....226
1218A-R.....163	B2712.....214	V25921.....31	PMV1908KT.....224	PMV81162PT.....226
1218A-R-SW.....163	V2730.....211	V25922-25.....255	PMV1908PT.....224	PMV81163PT.....226
1218C-9.....162	M2730P.....211	V25922.....31	PMV1909KT.....224	PMV81164PT.....226
1218F-9.....162	V2730P.....211	V25923-25.....255	PMV1909PT.....224	PMV81165PT.....226
1218F-C.....163	M2730S.....211	V25923.....31	PMV1909QT.....224	PMV81166PT.....226
1218KA-9.....161	V2730S.....211	V25924-25.....255	PMV1913QT.....224	PMV81181PT.....226
1218KC-9.....162	2753A.....238	V25924.....31	PMV1955KT.....225	PMV81183PT.....226
1218KR-9.....161	2753R.....238	95010-1.....246	PMV1955QT.....225	PMV81187PT.....226
1218R-9.....161	2757.....50	95011-1.....246	PMV1956QT.....225	PM-CM-0714-Z.....259
1220A-10.....165	2954.....194	95020-1.....246	PMV2250GT.....225	PM-CM-1018-Z.....259
1220C-10.....165	4153SA.....143	95021-1.....246	PMV2250PT.....225	PM-ECK-T.....227
1220KA-10.....165	P4153SA.....143	95023-1.....247	PMV2260GT.....225	PM-ICM-0919-Z.....259
1220KC-10.....165	4154SA.....143	95051-1.....247	PMV2260PT.....225	
1220KR-10.....165	P4154SA.....143	95083-1.....246	PMV2270GT.....225	
1220R-10.....165	4155SA.....143	95087-1.....246	PMV2270PT.....225	
1223A-10.....165	P4155SA.....143	95093-1.....247	PMV3157QT.....225	
1223A-4.....166	4155SA-BT3.....143	PMV0002-T.....221	PMV4008KT.....225	
1223A-R-MV.....166	4156SA.....143	PMV0099PT.....227	PMV4050KT.....225	
1223C-10.....165	P4156SA.....143	PMV0300T.....227	PMV4138KT.....225	
1223KA-10.....165	4156SA-BT3.....143	PMV0690PT.....227	PMV4238KT.....225	
1223KC-10.....165	4354A.....60	PMV0840PT.....222	PMV4239KT.....225	
1223KR-10.....165	4354R.....60	PMV0905PT.....222	PMV4339KT.....225	
1223R-10.....165	4484A-1.....58	PMV0906PT.....222	PMV4439KT.....225	
1223R-4.....166	4484R-1.....58	PMV0950PT.....222	PMV4539KT.....225	
1268A-MTC.....170	4731.....34	PMV0961PT.....222	PMV5140PT.....226	
1268A-MV.....170	4741B.....76	PMV0963PT.....222	PMV5141PT.....226	
P1268A-MV.....170	5000.....195	PMV0967PT.....222	PMV5142PT.....226	
1268A-MVC.....170	B5400A.....214	PMV0969PT.....222	PMV5143PT.....226	
P1268A-MVC.....170	V5400A.....214	PMV1100KT.....222	PMV5501PT.....216	
1268A-MVC-BT2.....170	B5400B.....214	PMV1100PT.....222	PMV5503PT.....217	
1268R-MV.....170	V5400B.....214	PMV1200KT.....222	PMV5504PT.....217	
P1268R-MV.....170	V5401.....214	PMV1200PT.....222	PMV5509PT.....217	
1268R-MVC.....170	5404.....211	PMV1268KT.....223	PMV5510PT.....217	
P1268R-MVC.....170	5406P.....211	PMV1300KT.....223	PMV5511PT.....217	
1268W-MV.....170	5406S.....211	PMV1300PT.....223	PMV5512PT.....217	
	5407P.....211	PMV1544KT.....222	PMV5513PT.....218	



## DEFENDER HARNESS/LIGHTING SYSTEM

*Modular harness technology that corrosion can't touch!*



***Its advanced technology is unlike any standard harness system ever built.***

Peterson's **DEFENDER®** is the world's most advanced vehicle harness/lighting system. Proven *over 4 billion* rugged miles by major fleets, our modular DEFENDER is still performing like new—virtually maintenance-free!

That's why Peterson is proud to back DEFENDER with an iron-clad warranty against defects and corrosion for a **full 10 years**. And why we're confident it's the corrosion-proof harness/lighting solution that OEs and fleets have been waiting for.

### **HIGH TECH CONQUERS CORROSION**

The chemical cocktails lurking on today's roads eat trailers and electric systems alive. In fact, corrosion is the trucking industry's #1 cause of electrical system failures, costing billions in repairs and equipment downtime.

So Peterson and our Maxi-Seal division committed to build not just a superior harness/lighting system, but to create a real solution to profit-killing corrosion—the DEFENDER®.

### **BUILT TO LAST—GUARANTEED**

Other harnesses may claim rugged reliability, but the Defender system has logged over four billion real-world test miles to prove it. In all those miles, the system's fail rate is less than 1%!

If you're a fleet manager, think what a corrosion-proof Defender system on your trailers could save in maintenance and repair costs... equipment down time... and FMCSA citations for lighting outages.

In fact, just one less trip to the repair shop will pay the difference in the price of Defender versus a standard harness system.

Why fight today's costly corrosion problems with yesterday's harness technology? Now you can win that war with the Defender Harness System. Proudly made in the USA—and only from Peterson.



- **Modular Design**
- **Heavy Duty Terminals**
- **Improved Bullets**
- **Dual Isolated Grounding**
- **Advanced Silicone Seals**
- **Integrated Moisture Barrier™**
- **Improved Breakout Design**
- **Patented Hard-Shell J560s**
- **Sealed Ring Terminals**

## PULSE INTELLIGENT TRAILER SYSTEM

Smart CAN-Bus technology for fleet trailers.

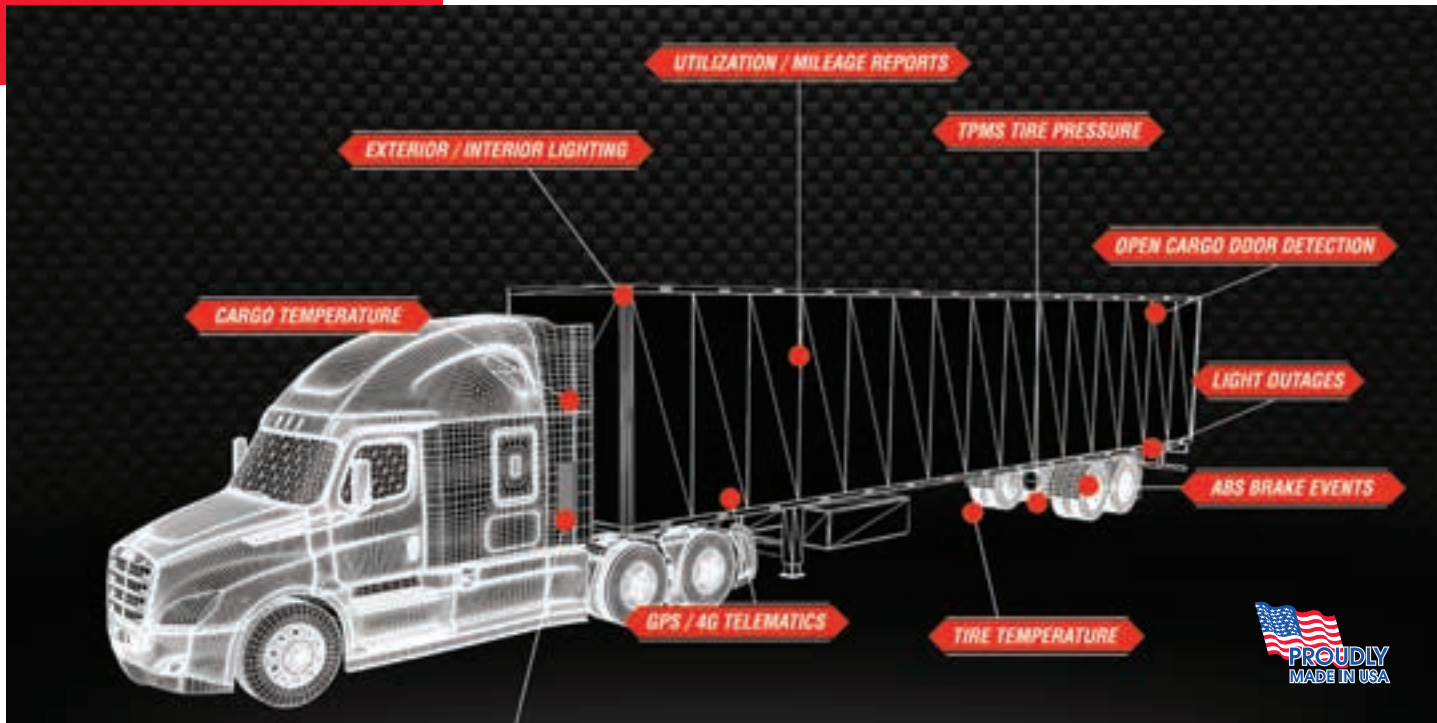

Peterson thinks it's time that fleet trailers got as smart as today's high-tech trucks, and is proud to introduce its patented **PetersonPULSE™** intelligent trailer system.

**PULSE** is the unique trailer solution that brings CAN-Bus technology and telematic capability to trailers. Engineered specifically for fleet trailers, **PULSE** not only controls and detects real-time status of vital trailer system — lights, ABS brakes, tire pressure, cargo temperature, and more — but also alerts drivers and fleet managers via Bluetooth and cellular communications.

"**PULSE** brings trailers up to speed with today's smartest trucks," said Peterson's VP of Engineering, Cory Adams. "By signaling trailer issues as they happen, **PULSE** enhances the safety of driver and cargo, and helps avoid road incidents, CSA violations, and costly fines."

Peterson developed **PULSE** in partnership with industry leaders in TPMS/ABS and telematic technology. The system features Peterson's LumenX LED lighting package and the harness-building expertise of the company's Maxi-Seal division.

**PetersonPULSE** is engineered to CAN-Bus specifications, with high-speed, twisted-pair communication wires and sensors installed throughout the trailer. All components are fully sealed, vibration tested, and built for long life.

Compared to the heavy, multi-wire cabling of traditional harnesses, **PULSE** twisted-pair cabling is lighter weight, flexible, and installation friendly.

The **PULSE** cabling links front and rear control modules, system sensors, and communication components—just like computers in a network. "It's like an

information super highway," Adams said. "Whether a trailer is parked or underway, **PULSE** enables real-time monitoring of all trailer systems — anytime, anywhere. There's even a backup battery to power the system whether or not the trailer is connected to the tractor."

With a mobile device, a driver can do pre-trip walk-around inspections to check for issues with any trailer system — a "Know Before You Go" safeguard. On the road, **PULSE's** trailer intelligence detects any issues and sends alerts via Bluetooth to the driver's smart phone or tablet. Alerts can also be sent to fleet managers via a cellular network.

"**PetersonPULSE** makes fleet trailers as smart—and safe—as today's new trucks," Adams said.

**PetersonPULSE** is all USA-made and ready to go today, only from Peterson.



- 1945** **Wilbur Peterson sets up shop at 14th & Chestnut in Kansas City.** Early products include “Big Pete” tire pumps for Western Auto’s famous Western Flyer bikes. In response to growing demand for aftermarket vehicle lighting, Peterson manufactures our first taillights.
- 1956** **Don Armacost Sr. buys Peterson Manufacturing;** annual sales are \$750,000.
- 1960** The growing company moves to a **35,000-sq.-foot.** facility.
- 1961** Peterson innovation makes industry news with the **VIBAR® socket** — first to protect fragile lights from vehicle vibration.
- 1968** We welcome **Anderson Marine and Mission Plastics** to the corporate family.
- 1970** Rapid growth dictates another relocation to our current site in **Grandview, Missouri.**
- 1974** The first of several **major plant expansions** boosts our warehousing capacity for finished goods.
- 1991** Further expansion increases our production capacity and makes room for **Mission Plastics North.** We acquire **Transworld Products** to meet the growing global demand.
- 1995** Peterson leads the industry in earning **ISO 9001/QS-9000 registration.** We introduce our first **Piranha®-style LED** light and launch a 39-LED round S/T/T with innovative lens optics.
- 1996** The efficiencies of our vertically integrated corporate campus are enhanced significantly with the addition of **Vector Tool & Engineering.** World-class design technology and mold-building expertise are now part of the family. This same year, Peterson partners with Alloyd in launching an automated blister packaging system.
- 2003** A 60,000-sq.-ft. warehouse addition ensures our ability to maintain an **industry-leading 98% fill rate** on orders. We launch our multi-function Strobe & Turn LED for the refuse industry — another lighting first.
- 2005** Our custom wiring harness subsidiary, **Maxi-Seal,** moves into a state-of-the-art 65,000-sq.-ft. addition.
- 2006** High demand for our lights and growth in Peterson subsidiaries prompt expansions that bring our 44-acre Grandview campus to over **670,000-sq. feet** under roof.
- 2007** Peterson receives **Caterpillar’s Silver Award,** becoming the first lighting supplier ever to earn such an award.
- 2009** Global expansion marks our year as **Peterson Europe** adds over two dozen countries to our list of international trade partners. They join Australia, Canada, Mexico, New Zealand and South Africa in handling our ECE product line.
- 2010** Peterson’s subsidiary, Maxi-Seal, launches the **Defender® System** in the truck-trailer industry — specifically designed for fleet dry van, reefer, flatbeds, tankers, and grain trailers.
- 2011** Peterson continues automation and equipment expansion with the purchase of SMT technology, allowing us to populate our own LED boards. **Mission Plastics** introduces an industry first with insert molding technology.
- 2012** We introduce our **LumenX® LED** line, including S/T/T lights, turn signals, and backup lights. LumenX® are brighter than standard LEDs, and brighter is safer!
- 2013** Grandview’s “Quiet Giant” is now a **quarter-billion-dollar corporation of 11 companies** and more than 3,000 people working in global transportation-related industries.
- 2014** Peterson launches our first **LED headlight,** a 7” round, Par56 unit which earns a HDT Top 20 products award.
- 2015** The Defender® System surpasses **4 billion miles** of over-the-road performance — virtually maintenance-free.
- 2017** Peterson continues manufacturing excellence with the upgraded **ISO9001:2015** certification.
- 2018** We launch our intelligent trailer system, **Peterson PULSE®** at the 2018 TMC Show in Atlanta; it’s named to HDT’s Top 20 new products list.

# PETERSON'S CORPORATE HISTORY

**Founded in 1945** and owned by the Armacost family since 1956, Peterson has grown to a quarter-billion-dollar, multi-faceted corporation serving customers across America, Canada, Mexico, Europe, South America, Australia, New Zealand, China, and the Middle East—and earning the nickname of “Quiet Giant” in the Kansas City-area suburb of Grandview, Missouri.

President and CEO, Don Armacost, Jr., whose father acquired the business, credits the company’s success to its long history of square dealings with customers, suppliers and employees. “That tradition has brought us a long ways,” he said. “We’re not about to change it.”

From its 44-acre Grandview corporate campus, Peterson operates a 670,000 sq.-ft. facility staffed and equipped for cutting-edge manufacturing. The vertically integrated operation includes engineering and design, photometric and environmental testing, tool and die production, harness and wire manufacturing, plastic injection molding, final assembly, warehousing, sales and customer service.

In building its familiar PM brand, Peterson has made USA quality and value the company-wide standard. From engineering products to exceed federal minimums by 25%, to delivering those products with an industry-best 98% fill-rate, Peterson has proved itself a count-on business partner.



**Don Armacost, Sr.**

As CEO Don Armacost, Jr. says, “While we celebrate our 75th year, my dad’s vision for Peterson and our extraordinary associates will continue to guide our future: ‘Our goal has never been to be the biggest’, dad said. ‘Just the best.’”



**Don Armacost, Jr.**

# PETERSON'S CORPORATE FAMILY

In addition to Peterson Manufacturing, these highly specialized companies contribute to the Peterson corporate success story. Their outstanding products and services further enhance Peterson's reputation for quality with customers around the globe.

**Anderson Marine** • [www.amdlights.com](http://www.amdlights.com)

Quality innovations in boat lights, trailer lights, harnesses, and accessories for the marine industry.

**Maxi-Seal Harness** • [www.maxisealharness.com](http://www.maxisealharness.com)

Custom-designed sealed harness systems for the light, medium, and heavy-duty truck and trailer industry.

**Mission Plastics Arkansas/Mission Plastics North** • [www.missionplasticsnorth.com](http://www.missionplasticsnorth.com)

Two companies molding the future in high-tech plastics for some of the world's leading companies.

**D&D Aviation** • [www.kcac.com](http://www.kcac.com)

Delivering the best in safe, convenient air charter services for corporate travel.

**KCAC Aviation** • [www.kcac.com](http://www.kcac.com)

Offering all the amenities of a full-service fixed base operator (FBO), from aircraft sales and service to fuel, aircraft management, charters, and more. KCAC Aviation is located in Olathe, KS.

**Transworld Products** • [www.twproducts.com](http://www.twproducts.com)

An international sourcing company providing product solutions for companies seeking global manufacturing.

**Vector Tool & Engineering** • [www.vectortool.com](http://www.vectortool.com)

Linking specialized skills with advanced design technology to tool exacting solutions in on-site mold-building, tool repair, and alterations.

**Peterson Manufacturing circa 1956**



**Peterson Manufacturing circa 2019**

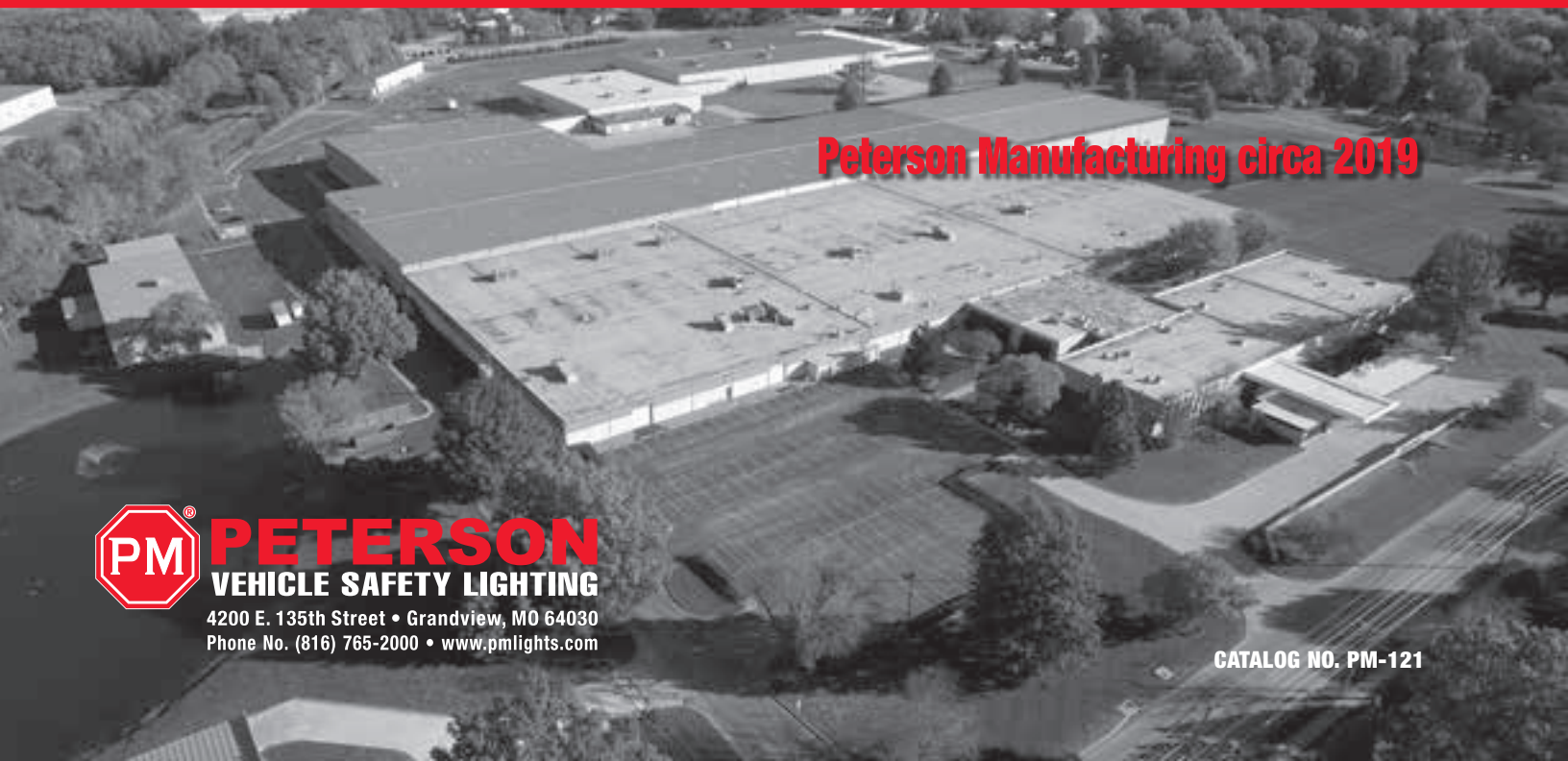

**PETERSON**  
**VEHICLE SAFETY LIGHTING**

4200 E. 135th Street • Grandview, MO 64030  
Phone No. (816) 765-2000 • [www.pmlights.com](http://www.pmlights.com)

CATALOG NO. PM-121